

# **EOLIEN PARKS VUTCANI – ALBESTI**

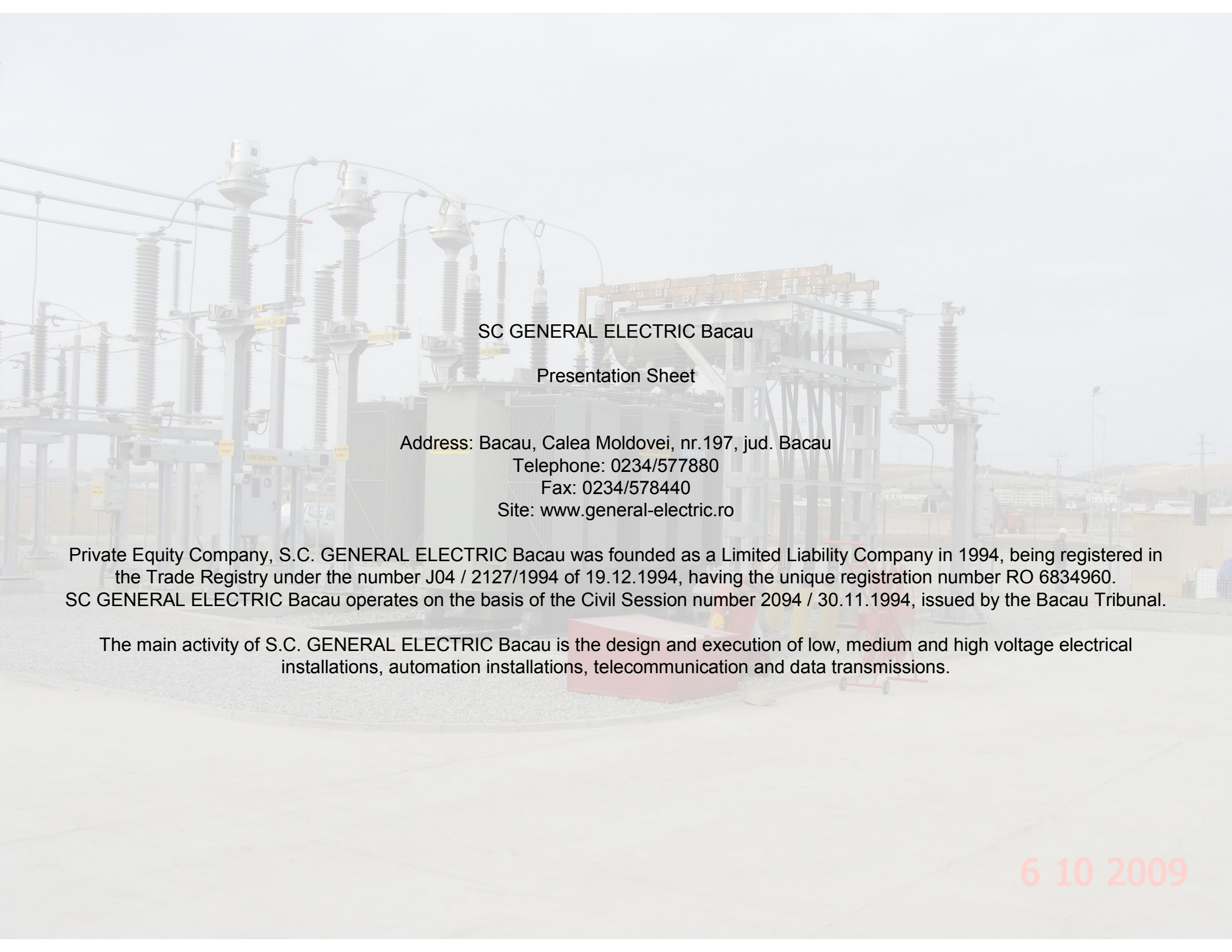



SC GENERAL ELECTRIC Bacau

Presentation Sheet

Address: Bacau, Calea Moldovei, nr.197, jud. Bacau

Telephone: 0234/577880

Fax: 0234/578440

Site: [www.general-electric.ro](http://www.general-electric.ro)

Private Equity Company, S.C. GENERAL ELECTRIC Bacau was founded as a Limited Liability Company in 1994, being registered in the Trade Registry under the number J04 / 2127/1994 of 19.12.1994, having the unique registration number RO 6834960. SC GENERAL ELECTRIC Bacau operates on the basis of the Civil Session number 2094 / 30.11.1994, issued by the Bacau Tribunal.

The main activity of S.C. GENERAL ELECTRIC Bacau is the design and execution of low, medium and high voltage electrical installations, automation installations, telecommunication and data transmissions.

6 10 2009

Production schedule:

A.- Construction works:

- Construction of electrical networks of 0,4-400 KV, including P.T. 20 / 0.4 KV and connections;
- Execution of indoor electrical installations for civil and industrial constructions;
- Execution of electrical installations of weak currents (relay protection, automation, signaling, pilot wire cable, telecommunication lines, fiber optic cable, etc.);
- Execution of constructions related to electrical networks 0,4-400 KV;
- Execution of paratrasnet installations and earthing installations;
- Execution of automation installations.

B.- Design Works:

- Design of electrical networks of 0,4-400 KV, including P.T. 20 / 0.4 KV and connections;
- Design of internal electrical installations for civil and industrial constructions;
- Design of electrical installations of weak currents (relays protection, automation, signaling, pilot wire cable, telecommunication lines, fiber optic cable, etc.);
- Design of automation installations.

Certifications:

- Certification ISO 9001/2008 SRAC
  - Certification ISO 9001/2008 IQNET
  - Certification ISO 14001/2004 SRAC
  - - IQNET ISO 14001/2004 Certification
  - Certification OHSAS 18001/2007 SRAC
- ANRE attestation for the domains: A, B, C1B C2B, D2, E1, E2

6 10 2009



## **Customers :**

### **- Electrica SA**

- Transelectrica SA**
- Hidroelectrica SA**
- Diana Forest SA**
- Romtelecom SA**
- MobiFon SA**
- Orange SA**
- Romatsa SA**
- SNIF SA**
- LukOil SA**
- Rompetrol SA**
- Dedeman SRL**

### **- BCR**

- Cominco SA**
- SELGROS CASH@CARRY**
- SC BELROM CINCI**
- E.ON MOLDOVA**
- KAUFLAND ROMANIA**
- SIEMENS ROMANIA**
- BELROM CINCI**
- ELCOMEX IEA**





I. MAIN PROJECTS (done):

- DEVIATION LEA 110 Kv on the territory of SC SELGROS CASH @ CARRY SUCEAVA;
- Replacement of capacitor battery on the medium voltage side in stations 110/20 Kv: Targu Neamt, Racaciuni, Moinesti, Milcov.
- Station 110/20 / kv Egger Radauti;
- Replacement of 110 Kv circuit breakers in Moinesti station;
- Replacement Physically Exceeded Switch in PA 106, PA 200-Iasi
- Selgros Cash supermarket supermarket @ Carry -Suceava;
- Power supply KAUF LAND - Roman supermarket;
- Power supply KAUF LAND supermarket - Piatra Neamt;
- Power supply - Dedeman Truks Bacau;
- Modernization of LES 6 Kv station 110/20 kv Letea - PT 165 Bacau;
- Installation of remote-controlled separators and reclosers on LEA 20 Kv;
- Extend electrification village Oniscani Bacau;
- INT Izvorul Alb Neamt County.

6 10 2009

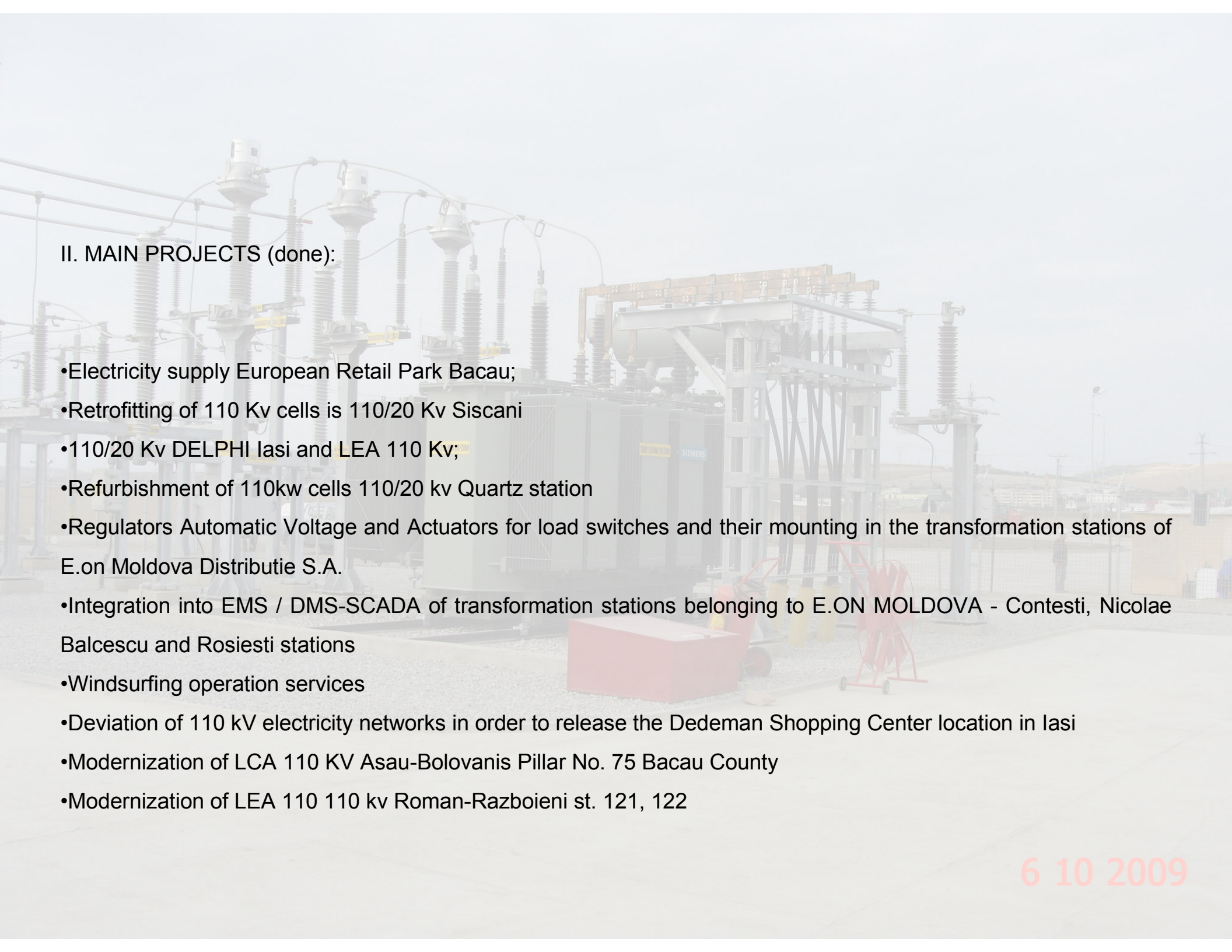

## II. MAIN PROJECTS (done):

- Electricity supply European Retail Park Bacau;
- Retrofitting of 110 Kv cells is 110/20 Kv Siscani
- 110/20 Kv DELPHI Iasi and LEA 110 Kv;
- Refurbishment of 110kv cells 110/20 kv Quartz station
- Regulators Automatic Voltage and Actuators for load switches and their mounting in the transformation stations of E.on Moldova Distributie S.A.
- Integration into EMS / DMS-SCADA of transformation stations belonging to E.ON MOLDOVA - Contesti, Nicolae Balcescu and Rosiesti stations
- Windsurfing operation services
- Deviation of 110 kV electricity networks in order to release the Dedeman Shopping Center location in Iasi
- Modernization of LCA 110 KV Asau-Bolovanis Pillar No. 75 Bacau County
- Modernization of LEA 110 110 kv Roman-Razboieni st. 121, 122

6 10 2009



CERTIFICATE



AUTORITATEA NAȚIONALĂ DE  
REGLEMENTARE ÎN DOMENIUL ENERGIEI



În conformitate cu Decizia președintelui ANRE nr. 2166/ 23-07-2013 se acordă Societății Comerciale GENERAL ELECTRIC S.R.L. cu sediul în municipiul Bacău, Calea Moldovei, nr. 197, județul Bacău, înmatriculată la Oficiul Registrului Comerțului sub nr. J04/ 2127/ 1994,

**ATESTAT**

**nr. 9172/ 23-07-2013**

- de tip C2B pentru “executare de linii electrice, aeriene sau subterane, cu tensiuni nominale de 0,4 kV ÷ 110 kV și posturi de transformare cu tensiunea nominală superioară de cel mult 20 kV”,
- de tip E2 pentru “executare de stații electrice și de lucrări la partea electrică a centralelor”.

Atestatul este valabil până la 23-07-2018, în condițiile prevăzute în anexă și existenței operatorului economic pe lista titularilor de atestate valabile, afișată pe site-ul [www.anre.ro](http://www.anre.ro).

PREȘEDINTE

NICULAE HAVRILET



Atestatul nu conduce la transferul de responsabilități de la persoana juridică la organul de atestare și nici nu exonerează titularul de obligațiile ce îi revin.

Data emiterii: 23-07-2013

6 10 2009



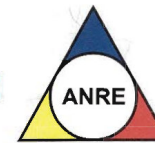

În conformitate cu **Decizia președintelui ANRE nr. 1244/ 26-05-2014** se acordă societății **GENERAL ELECTRIC S.R.L.** cu sediul în municipiul Bacău, Calea Moldovei, nr. 197, județul Bacău, înmatriculată la Oficiul Registrului Comerțului sub nr. **J04/ 2127/ 1994**,

## **ATESTAT**

**nr. 10087/ 26-05-2014**

- de tip **C1B** pentru “proiectare de linii electrice, aeriene sau subterane, cu tensiuni nominale de  $0,4 \text{ kV} \div 110 \text{ kV}$  și posturi de transformare cu tensiunea nominală superioară de cel mult  $20 \text{ kV}$ ”,
- de tip **D2** pentru “executare de linii electrice aeriene și subterane cu tensiuni nominale de  $110 \text{ kV} \div 400 \text{ kV}$ ”,
- de tip **E1** pentru “proiectare de stații electrice și de instalații aparținând părții electrice a centralelor”.

Atestatul este valabil până la **26-05-2019**, în condițiile prevăzute în anexă și existenței operatorului economic pe lista titularilor de atestate valabile, afișată pe site-ul [www.anre.ro](http://www.anre.ro).

**PREȘEDINTE**

**NICULAE HAVRILEȚ**



Atestatul nu conduce la transferul de responsabilități de la persoana juridică la organul de atestare și nici nu exonerează titularul de obligațiile ce îi revin.

Data emiterii: 26-05-2014





# AUTORITATEA NAȚIONALĂ DE REGLEMENTARE ÎN DOMENIUL ENERGIEI

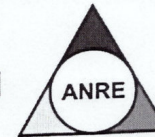

În conformitate cu Decizia președintelui ANRE nr. 1106/ 25-05-2015 se acordă societății  
**GENERAL ELECTRIC S.R.L.** cu sediul în municipiul Bacău, Calea Moldovei, nr. 197,  
județul Bacău, înmatriculată la Oficiul Registrului Comerțului sub nr. J04/ 2127/ 1994,

## ATESTAT

*nr. 11008/ 25-05-2015*

- de tip A pentru “încercări de echipamente și instalații electrice”,
- de tip B pentru “proiectare și executare de instalații electrice exterioare/  
interioare pentru incinte/ construcții civile și industriale, bransamente  
aerene și subterane, la tensiunea nominală de 0,4 kV”.

Atestatul este valabil până la 25-05-2020, în condițiile  
prevăzute în anexă și existenței operatorului economic pe lista  
titularilor de atestate valabile, afișată pe site-ul [www.anre.ro](http://www.anre.ro).

PREȘEDINTE

NICULAE HAVRILET



Atestatul nu conduce la transferul de responsabilitate de la persoana juridică  
la organul de atestare și nici nu exonerează titularul de obligațiile ce îi revin.

Data emiterii: 25-05-2015

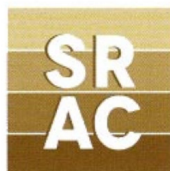

# C E R T I F I C A T

*SRAC certifică organizația/ certifies the organisation*

## **GENERAL ELECTRIC S.R.L.**

*Calea Moldovei, nr. 197, Bacău, jud. Bacău*

**pentru următoarele activități/  
for the following fields of activities**

*Proiectare, execuție, livrare, reparații și măsurări pentru instalații și echipamente electrice 0,4 - 400 kV, automatizări, curenți slabi, transmisii date*

*Design, execution, delivery, repairing and measurement of electric installations and equipment of 0.4 - 400 kV, automations, low currents, data transmission*

că are implementat și menține un **sistem de managementul calității** conform condițiilor din standardul

which has implemented and maintains a **quality management system** which fulfils the requirements of the standard

### **SR EN ISO 9001:2008 (ISO 9001:2008)**

Valabilitatea certificatului este condiționată de efectuarea supravegheților anuale până la data de:



nr. certificat/ certificate registration no. 96  
data inițială a certificării/ initial certification date 30 martie 1999  
data recertificării/ reissuing date 29 august 2014  
data ultimei actualizări/ last update -  
valabil până la/ valid until 29 august 2017 (cu condiția vizării anuale)  
SRAC CERT SRL, Str. Vasile Pârvan Nr. 14, Sector 1, București www.srac.ro

**Director General  
Ing. Mihaela Cristea**

6 10 2009





acreditat pentru  
CERTIFICARE



SR EN ISO/CEI 17021:2011  
CERTIFICAT DE ACREDITARE  
SM 004



# C E R T I F I C A T

*SRAC certifică organizația/ certifies the organisation*

## **GENERAL ELECTRIC S.R.L.**

*Calea Moldovei, nr. 197, Bacău, jud. Bacău*

**pentru următoarele activități/  
for the following fields of activities**

*Proiectare, execuție, livrare, reparații și măsurări pentru instalații și echipamente  
electrice 0,4 - 400 kV, automatizări, curenți slabi, transmisii date*

*Design, execution, delivery, repairing and measurement of electric installations  
and equipment of 0.4 - 400 kV, automations, low currents, data transmission*

că are implementat și menține un  
**sistem de management de mediu**  
conform condițiilor din standardul

which has implemented and maintains a  
**environmental management system**  
which fulfils the requirements of the standard

### **SR EN ISO 14001:2005 (ISO 14001:2004)**

Valabilitatea certificatului este condiționată de efectuarea supravegheților anuale până la data de:



08-  
2015

08-  
2016

nr. certificat/ certificate registration no. **1921**  
data inițială a certificării/ initial certification date **17 iulie 2008**  
data recertificării/ reissuing date **29 august 2014**  
data ultimei actualizări/ last update -  
valabil până la/ valid until **29 august 2017** (cu condiția vizării anuale)  
SRAC CERT SRL, Str. Vasile Pârvan Nr. 14, Sector 1, București www.srac.ro

**Director General  
Ing. Mihaela Cristea**

6 10 2009



# C E R T I F I C A T

SRAC certifică organizația/ certifies the organisation

## GENERAL ELECTRIC S.R.L.

Calea Moldovei, nr. 197, Bacău, jud. Bacău

pentru următoarele activități/  
for the following fields of activities

Proiectare, execuție, livrare, reparații și măsurări pentru instalații și echipamente electrice 0,4 - 400 kV, automatizări, curenți slabi, transmisii date

Design, execution, delivery, repairing and measurement of electric installations and equipment of 0.4 - 400 kV, automations, low currents, data transmission

că are implementat și menține un sistem de management al sănătății și securității ocupaționale conform condițiilor din referențialul

which has implemented and maintains an occupational health and safety management system which fulfils the requirements of the reference standard

## SR OHSAS 18001:2008 (BS OHSAS 18001:2007)

Valabilitatea certificatului este condiționată de efectuarea supravegheților anuale până la data de:



nr. certificat/ certificate registration no. 992  
data inițială a certificării/ initial certification date 17 iulie 2008  
data recertificării/ reissuing date 29 august 2014  
data ultimei actualizări/ last update -  
valabil până la/ valid until 29 august 2017 (cu condiția vizării anuale)  
SRAC CERT SRL, Str. Vasile Pârvan Nr. 14, Sector 1, București www.srac.ro

Director General  
Ing. Mihaela Cristea

6 10 2009





THE INTERNATIONAL CERTIFICATION NETWORK

# CERTIFICATE

**IQNet and  
SRAC**  
hereby certify that the organization

**GENERAL ELECTRIC S.R.L.**  
Calea Moldovei, nr. 197, Bacău, jud. Bacău

for the following field of activities

Design, execution, delivery, repairing and measurement of electric installations and equipment of 0.4 - 400 kV, automations, low currents, data transmission

has implemented and maintains an

**Environmental Management System**

which fulfils the requirements of the following standard

**ISO 14001 : 2004**

Issued on : 2014 - 08 - 29

Validity date : 2017 - 08 - 29

**Registration Number : RO - 1921**



*Michael Drechsel*  
President of IQNet

*ing. Mihaela Cristea*  
SRAC General Manager



**IQNet Partners\*:**  
AENOR Spain, AFNOR Certification France, AIB-Vinçotte International Belgium, ANCE-SIGE Mexico, APCER Portugal, CCC Cyprus, CISQ Italy, CQC China, CQM China, CQS Czech Republic, Cro Cert Croatia, DQS Holding GmbH Germany, FCAV Brazil, FONDONORMA Venezuela, ICONTEC Colombia, IMNC Mexico, Inspecta Certification Finland, IRAM Argentina, JQA Japan, KFQ Korea, MIRTEC Greece, MSZT Hungary, Nemko AS Norway, NSAI Ireland, PCBC Poland, Quality Austria Austria, RR Russia, SII Israel, SIQ Slovenia, SIRIM QAS International Malaysia, SQS Switzerland, SRAC Romania, TEST St Petersburg Russia, TSE Turkey, YUQS Serbia.  
IQNet is represented in the USA by: AFNOR Certification, CISQ, DQS Holding GmbH and NSAI Inc.

\* The list of IQNet partners is valid at the time of issue of this certificate. Updated information is available under [www.iqnet-certification.com](http://www.iqnet-certification.com)

6 10 2009





THE INTERNATIONAL CERTIFICATION NETWORK

# CERTIFICATE

**IQNet and  
SRAC**  
hereby certify that the organization

**GENERAL ELECTRIC S.R.L.**  
Calea Moldovei, nr. 197, Bacău, jud. Bacău

for the following field of activities

Design, execution, delivery, repairing and measurement of electric installations and equipment of 0.4 - 400 kV, automations, low currents, data transmission

has implemented and maintains an

**Occupational Health and Safety System**

which fulfils the requirements of the following reference standard

**OHSAS 18001 : 2007**

Issued on : 2014 - 08 - 29

Validity date : 2017 - 08 - 29

*Registration Number : RO - 0992*



*Michael Drechsel*  
President of IQNet

*ing. Mihaela Cristea*  
SRAC General Manager



IQNet Partners\*:  
AENOR Spain AFNOR Certification France AIB-Vinçotte International Belgium ANCE-SIGE Mexico APCER Portugal CCC Cyprus  
CISQ Italy CQC China CQM China CQS Czech Republic Cro Cert Croatia DQS Holding GmbH Germany  
FCAV Brazil FONDONORMA Venezuela ICONTEC Colombia IMNC Mexico Inspecta Certification Finland IRAM Argentina  
JQA Japan KFQ Korea MIRTEC Greece MSZT Hungary Nemko AS Norway NSAI Ireland PCBC Poland  
Quality Austria Austria RR Russia SII Israel SIQ Slovenia SIRIM QAS International Malaysia  
SQS Switzerland SRAC Romania TEST St Petersburg Russia TSE Turkey YUQS Serbia  
IQNet is represented in the USA by: AFNOR Certification, CISQ, DQS Holding GmbH and NSAI Inc.

\* The list of IQNet partners is valid at the time of issue of this certificate. Updated information is available under [www.iqnet-certification.com](http://www.iqnet-certification.com)

6 10 2009



THE INTERNATIONAL CERTIFICATION NETWORK

# CERTIFICATE

**IQNet and  
SRAC**

hereby certify that the organization

**GENERAL ELECTRIC S.R.L.**  
Calea Moldovei, nr. 197, Bacău, jud. Bacău

for the following field of activities

Design, execution, delivery, repairing and measurement of electric installations and equipment of 0.4 - 400 kV, automations, low currents, data transmission

has implemented and maintains a

**Quality Management System**

which fulfils the requirements of the following standard

**ISO 9001 : 2008**

Issued on : 2014 - 08 - 29

Validity date : 2017 - 08 - 29

**Registration Number : RO - 0096**



*Michael Drechsel*  
President of IQNet

*ing. Mihaela Cristea*  
SRAC General Manager



**IQNet Partners\*:**

AENOR Spain AFNOR Certification France AIB-Vinçotte International Belgium ANCE-SIGE Mexico APCER Portugal CCC Cyprus  
CISQ Italy CQC China CQM China CQS Czech Republic Cro Cert Croatia DQS Holding GmbH Germany  
FCAV Brazil FONDONORMA Venezuela ICONTEC Colombia IMNC Mexico Inspecta Certification Finland IRAM Argentina  
JQA Japan KPQ Korea MIRTEC Greece MSZT Hungary Nemko AS Norway NSAI Ireland PCBC Poland  
Quality Austria Austria RR Russia SII Israel SIQ Slovenia SIRIM QAS International Malaysia  
SQS Switzerland SRAC Romania TEST St Petersburg Russia TSE Turkey YUQS Serbia  
IQNet is represented in the USA by: AFNOR Certification, CISQ, DQS Holding GmbH and NSAI Inc.

\* The list of IQNet partners is valid at the time of issue of this certificate. Updated information is available under [www.iqnet-certification.com](http://www.iqnet-certification.com)

6 10 2009





28.07.2013 14:41

















0 2009

















6 10 2009







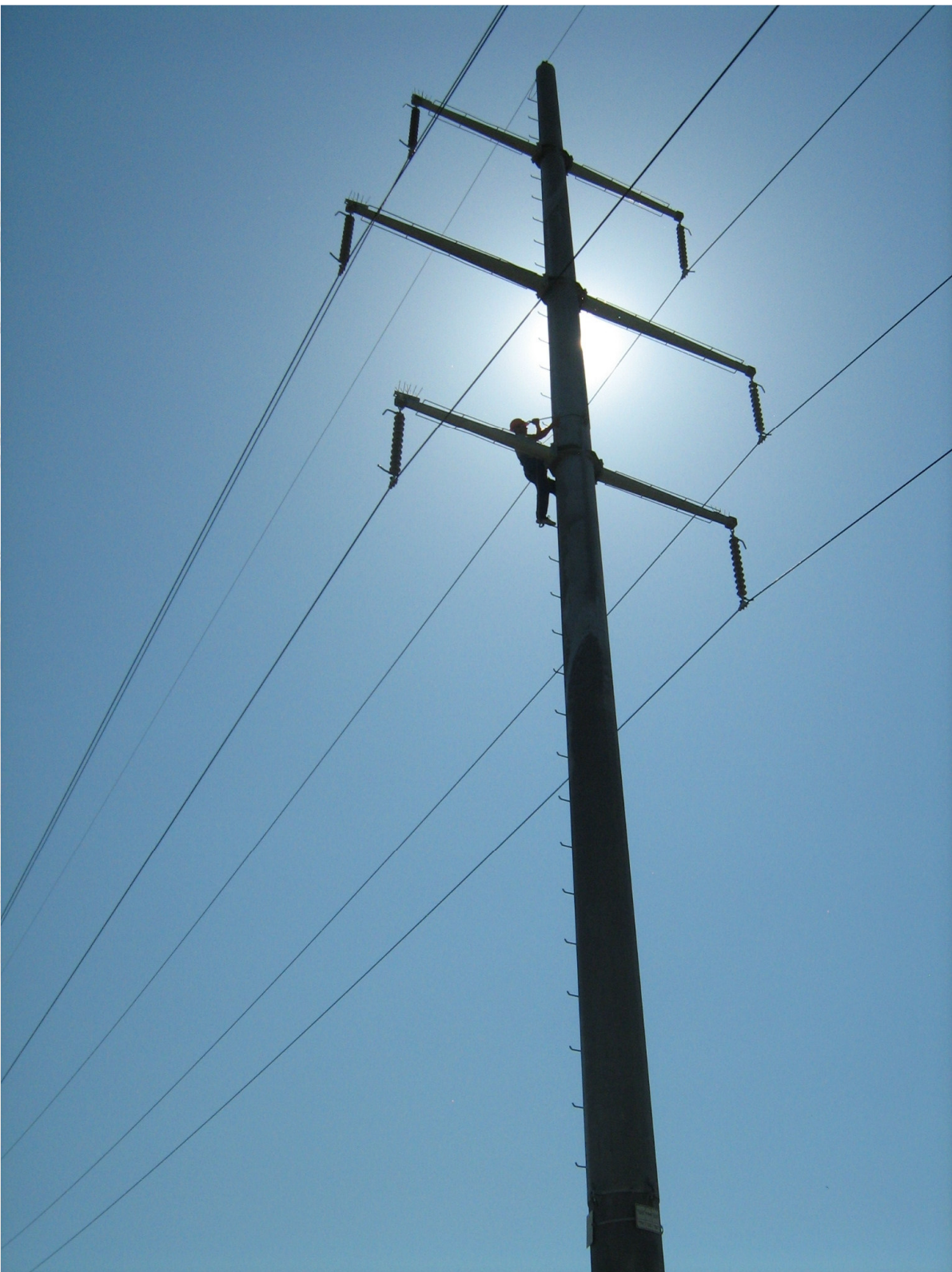

6 10 2009















# CONNECTION LEA 110 KV DELPHI STATION



5 8 2009

009



# CONNECTION LEA 110 KV DELPHI STATION





# TRANSFORMATION STATION 110/20 KV DELPHI





# TRANSFORMATION STATION

## 110/20 KV DELPHI





## Windfarms VUTCANI - ALBESTI (Vaslui County)

INVESTOR: EDP RENEWABLE SPAIN

PURPOSE: To capitalize the wind potential of the modova plateau with beneficial consequences on the environmental factors, by replacing the electric energy produced in the thermoenergetic installations and obtaining a quantity of electricity from renewable sources of about 80,500,000 kwh annually

Based on the Technical Communication of 2011 CEE Vutcani-Albesti has approved the power distribution of 52 MW / 54.2 MVA of which:

EDP Renewables 24 MW / 25 MVA - manufacturer

Sibioara Wind Farm 28 MW / 29.2 MVA - under the status of a sub-producer of EDPR.



## Windfarms VUTCANI - ALBESTI (Vaslui County)

### THE PROCESS AND THE INSTALATIONS - DESCRIPTION

The wind turbine balls transform the kinetic energy of wind into mechanical energy, which is transmitted via a transmission system (main shaft, gearbox, coupling) to a generator where mechanical energy is converted into electrical energy. The transformer installed in the wind turbine windshield increases the voltage to 0.69 kv at 20 kv.

Electricity is transmitted via underground medium voltage lines at a station where another transformer raises the voltage at the level corresponding to the high voltage power transmission lines from 20 Kv to 110 Kv.

1. VUTCANI wind farm consists of 12 wind turbines model V90 2MW produced by Vestas and wind power station 20 / 110kV Vutcani; Is located in the commune of VUTCANI, Vaslui county and has an area of approximately 700 ha. 2.The Albotian Parcel has an area of approximately 1800 ha and consists of 14 wind turbines V100 2MW produced by Vestas. The Albești Eolian Park is connected to the Vutcani Wind Power Station.

The wind turbine balls transform the kinetic energy of wind into mechanical energy, which is transmitted via a transmission system (main shaft, gearbox, coupling) to a generator where mechanical energy is converted into electrical energy. The transformer installed in the wind turbine windshield increases the voltage to 0.69 kv at 20 kv.

Electricity is transmitted via underground medium voltage lines at a station where another transformer raises the voltage at the level corresponding to the high voltage power transmission lines from 20 Kv to 110 Kv.

1. VUTCANI wind farm consists of 12 wind turbines model V90 2MW produced by Vestas and wind power station 20 / 110kV Vutcani; Is located in the commune of VUTCANI, Vaslui county and has an area of approximately 700 ha. 2.The Albești Park has an area of approximately 1800 ha and consists of 14 wind turbines V100 2MW produced by Vestas. The Albești Eolian Park is connected to the Vutcani Wind Power Station.



## Windfarms VUTCANI - ALBESTI (Vaslui County)

### □ Equipment description

- The Vutcani Eolian Park has 12 Vest 2 VW turbines produced by Vestas, with a tower height of 105 meters and a 45 meter long blade length. The Albești Eolian Park has 14 V100 2MW wind turbines produced by Vestas, with a tower height of 105 meters and a 50 meter blade length. The access to these turbines is done on the internal cobbled roads, totaling 23 km (18 km Vutcani and 5 km Albești). Access to the wind turbine is made in two ways - lift and access staircase. If the turbine is not powered, the access is made only on the access ladder using the built-in fall stop system.
- At the base of the turbine are the following electrical equipment: two or three cells, depending on how the turbine is connected to the grid, the local turbine control cabinet, auxiliary power control cabinet, the UPS cabinet and the elevator's cabinet.



## Windfarms VUTCANI - ALBESTI (Vaslui County)

CEED Vutcani, which serves both wind farms, is a 20 / 110kV external transformer station with two voltage levels: a 20kV level for turbine interconnection, and a 110kV level for the energy output of the park produced in the NPS (The National Energy System).

CEED Vutcani station occupies an area of approx. 1600 m<sup>2</sup>, fenced with concrete prefabricated concrete fence at the top with anti-climbing system. CEED Vutcani Station has an access road both for people and for the car. The perimeter of the station is divided as follows: a building block - a control block and an outside area where the technological installations are located, serviced by both the maintenance teams and the service stations of the station: waste picking, vacuuming, water supply. Also in the outer area is the waste collection point.



## Windfarms VUTCANI - ALBESTI (Vaslui County)

The building block - command block is divided as follows:

The EDPR command room, where operating and supervising the operations of the operating staff and the wind farm manager. In this room there are secondary circuit cabinets, battery storage cabinet, auxiliary AC cabinet (230Vac), DC power cabinet (110Vdc; 48Vdc), LEA cabinets, TRAFO, SCADA cabinet, RTU cabinet (Remote telecontrol unit).

The VESTAS command room, where turbine maintenance teams operate. In this room is the Vestas Online Server, the PPC cabinet and the aux PLC cabinet

The medium voltage cell cell comprised the compact type medium voltage cells without access to the live parts (voltage level = 20 kV) that connect the five LES lines that collect the energy produced by the twelve turbines Turbines in total, taking into account the Albești PE) and the other compensation equipments provided for the MV side, to the collector bar system.

The generating set room houses the generator group used to ensure the continuity in the power supply of the station's own services in case of disconnection from the NPS and an additional fuel tank (1000 liters). The room has external access only, provided with natural ventilation system and radiator heating, the floor is covered with fireproof concrete.



## Windfarms VUTCANI - ALBESTI (Vaslui County)

External electrical installations are as follows:

Trafo 20 / 110kV; P = 40 MVA; Manufacturer: INCOESA.

Trafo 20 / 110kV P = 30MVA Manufacturer: SIEMENS.

Trafo serv. aux. 20 / 0.4 kV; P = 100kVA; Manufacturer: INCOESA.

Create null coil: oil;

110kV switch: SF6;

Current measuring transformer 3 units: SF6;

Voltage Transformer 3 units: SF6

The installations at the power station are connected to NES through LES 110KV in the Munteni - Huși line.

The plant is provided with lightning arrays consisting of catching elements, descent elements and earthing elements of the station, made of copper conductor.



## Windfarms VUTCANI - ALBESTI (Vaslui County)

### Other plant facilities / utilities:

General and perimeter lighting installations with poles on pillars;

Drainage network for drainage water, a network that discharges the collected water into an oil separator - the basin is buried, covered with a metal cap; The collected water is then discharged outside the station;

Oil collection tank for accidentally leakage or leakage of oil from power transformers; The basin is buried, covered with a grill, connected to the oil sump collector basin;

Septic fiber reinforced polyester fiberglass

Domestic water tank.

In case of a power interruption of the station, the generator group enters into operation to maintain the operation of the station control systems and the interior lighting.

Works performed by General Electric are preventive and corrective (2 annuals)



## Windfarms VUTCANI - ALBESTI (Vaslui County)

### Advantages of wind energy production

In the current context, characterized by the alarming increase in pollution caused by the production of energy from the burning of fossil fuels, it is becoming increasingly important to reduce the dependence on these fuels.

Wind energy has already proven to be a very good solution to the global energy problem. The main advantage of wind energy is zero emission of pollutants and greenhouse gases due to the fact that no fuels are burned.

**There is no waste. Wind energy production does not involve the production of any kind of waste.**

**Reduced cost per unit of energy produced.**

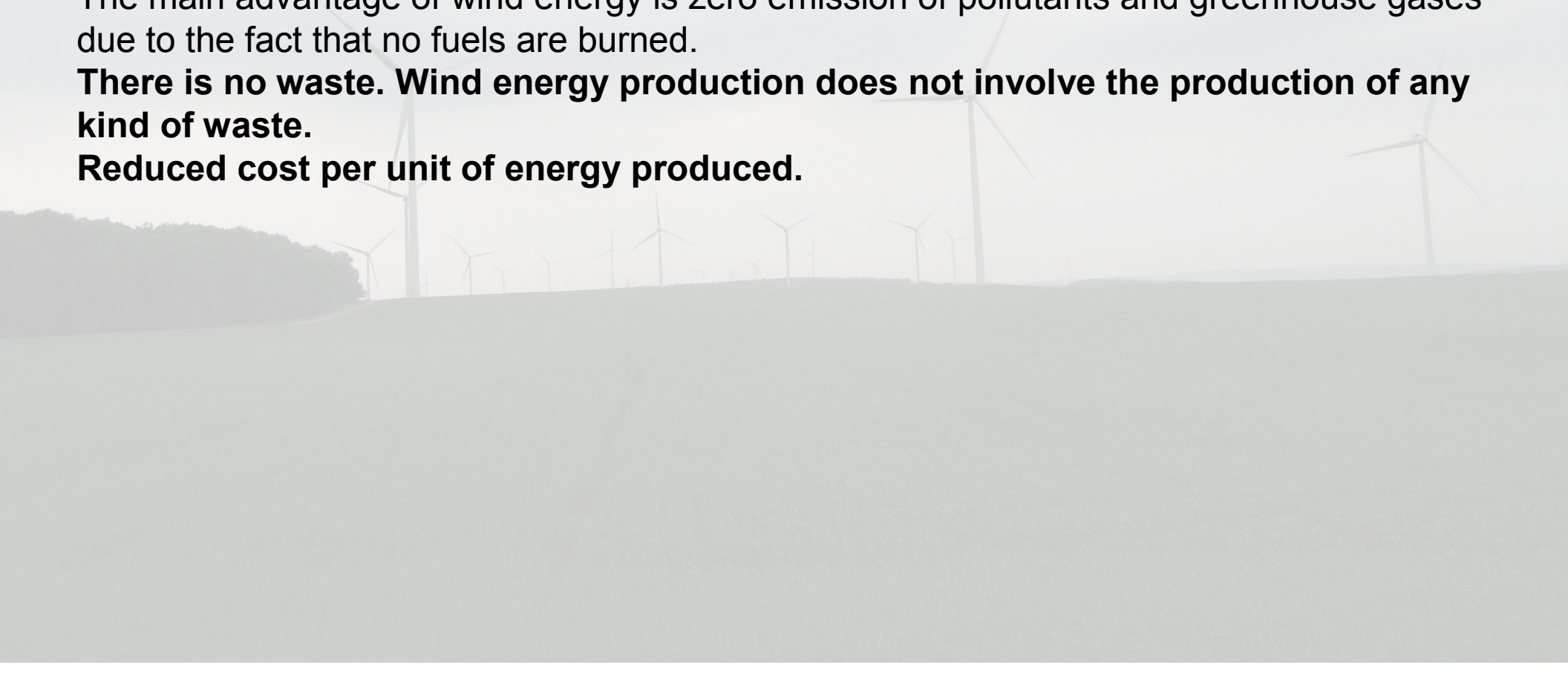



1 2 3 4 5 6 7 8

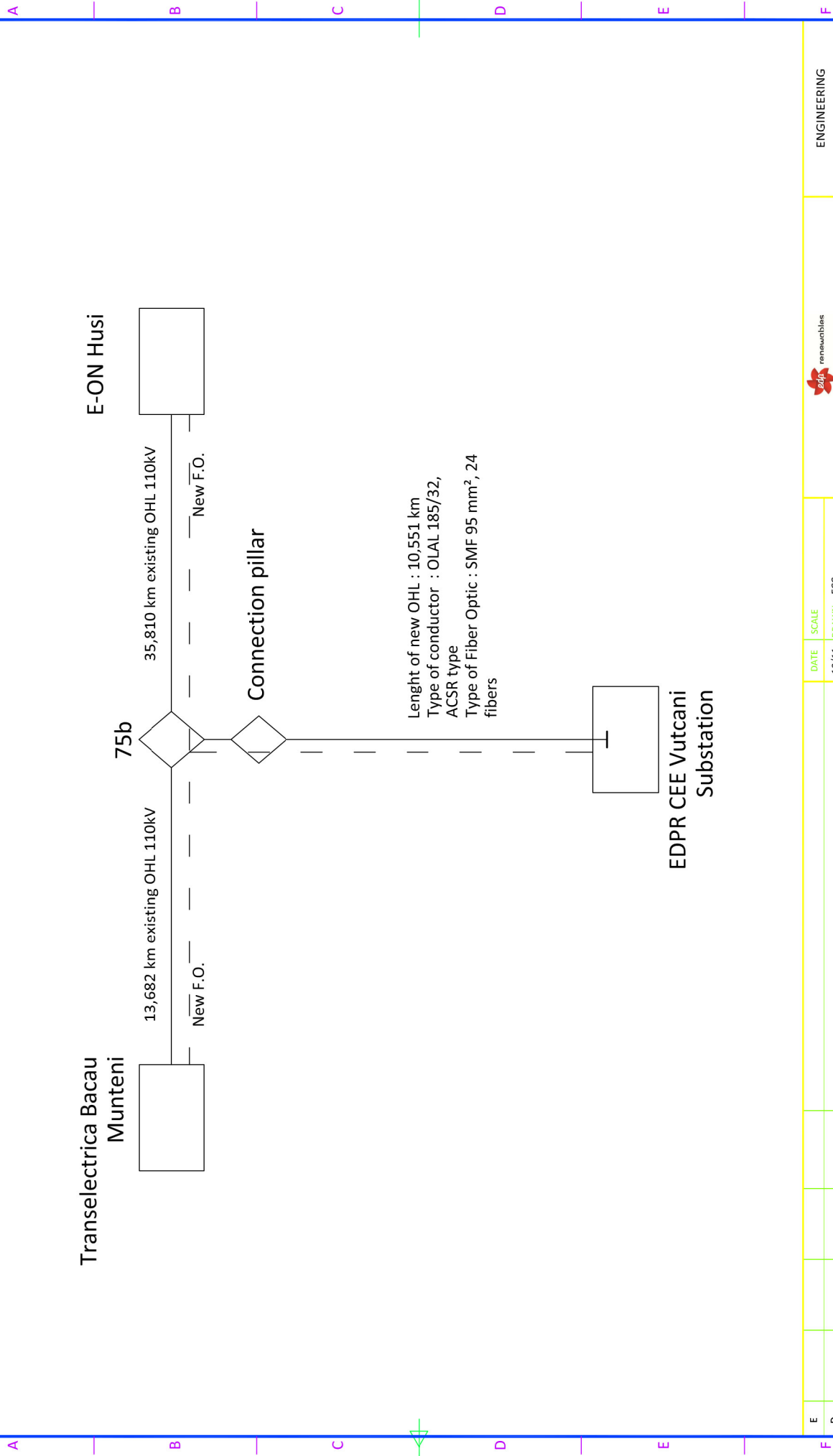

Transelectrica Bacau  
Munteni

E-ON Husi

EDPR CEE Vutcani  
Substation

75b

Connection pillar

13,682 km existing OHL 110kV

35,810 km existing OHL 110kV

New F.O.

New F.O.

Lenght of new OHL : 10,551 km  
 Type of conductor : OLAL 185/32,  
 ACSR type  
 Type of Fiber Optic : SMF 95 mm<sup>2</sup>, 24  
 fibers

EDIC.	DATE	DRAWN	CHECKED	APPROVED	MODIFICATION	DATE	SCALE
D	10/11	DRAWN	ECC			10/11	DRAWN ECC
C	10/11		CHECKED	ECC		10/11	CHECKED ECC
B	10/11			APPROVED	ECC	10/11	APPROVED ECC
Format A3							

  

ENGINEERING	
CURRENT EDITION I	Phase: X
NP Project:	Page: I
NP Doc.:	Cont: XX



PROJECT  
 INTEGRATION\_OF\_CEE\_VUTCANI\_TO\_RED/RET  
 VUTCANI



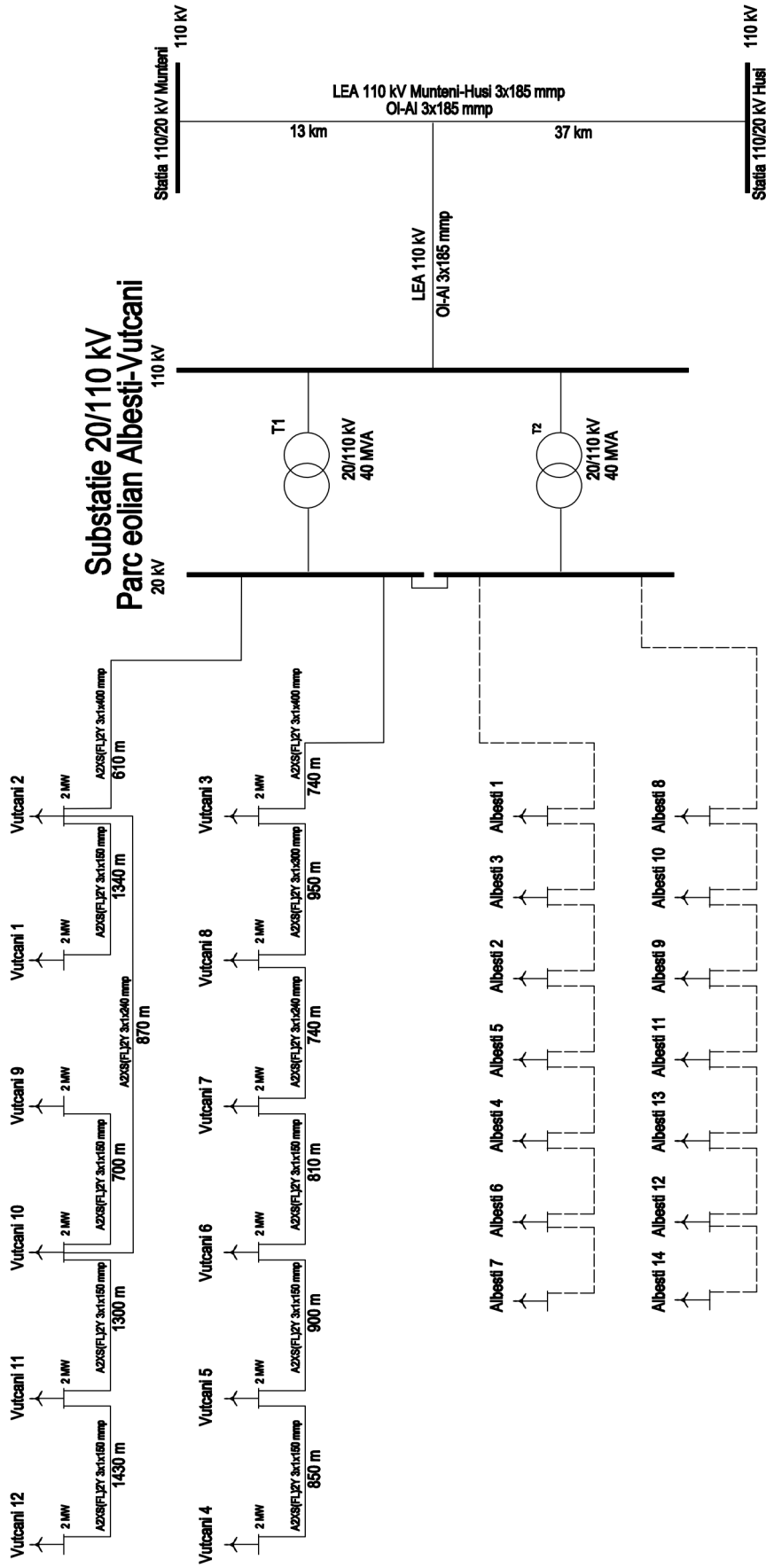

**LEGENDA:**

- Instalatii proiectate
- - - Instalatii in perspectiva

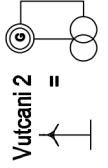

VERIFICATOR	NUME	SEMNATURA	GERINTA	REFERATE/PERTIZA NR./DATA
EXPERT				
SC Electrica Serv SA, SIEE ELECTRICA MOLDOVA				
Elaborator: ASE VISULUI - Serv. Tehnic Proiectie				
Beneficiar: EDP Renewables Romania, strada Maria Rosetti, nr. 6, Bucuresti				
Pr. nr.: 4/2008				
Titlu proiect: Racordarea la BEN a parcului de centrale eoliene, localitatea Vutcani, Judetul Vaslui				
Faza: PT+CS				
Titlu planșă: Schema electrica monofilara de racordare a parcului eoliene Vutcani si Albesti				
Planșă nr.: 1-1/4/2008				
Data: 07 - 2010				
Ing. Dima Daniela				
Ing. Dima Daniela				
DESEINAT				
PROIECTAT				
SEF PROIECT				
NUME				
SEMNATURA				
SCARA				