

# Renewable energy for local development: Transnational case studies

Compilation of case studies of applying renewable energies to local development transnationally implemented along IN2RURAL project: Stage 2

Coordinators: Leonor Hernández and Hèctor Beltran



Co-funded by the  
Erasmus+ Programme  
of the European Union



**GEOLIN**

**GENERAL ELECTRIC**

Place and year of edition:  
Castellón de la Plana (Spain), 2017

Coordinators:  
Leonor Hernández  
Hèctor Beltran

Authors:  
Vivien Balog  
Javier Castelló  
Zsuzsanna Kray  
Atena Georgiana Mouhanna  
Mario Muñoz  
Dóra Okos  
Jose Segarra  
Corneliu Zediu

Tutors:  
Imre Baják  
Francisco Colomer  
Noémi Fiser  
Roxana Grigore  
Carmen Ibáñez  
Zsuzsanna Kray  
Măgureanu Laurențiu  
Lluís Monjo  
Csaba Patkós  
Gabriel Puiu  
Vicent Querol  
Jose Segarra  
Csaba Szűcs  
Valerica Rusu  
Sándor Némethy



CC BY-NC-SA

This licence allows others remix, transform, or build upon the material without commercial purposes, giving appropriate credit and distributing their contributions under the same license as the original.

DOI: <http://dx.doi.org/10.6035/IN2RURAL.2017.02>

The PDF version of this document is available in:  
<http://in2rural.ub.ro/>, <http://in2rural.uji.es/> and <http://repositori.uji.es/xmlui/handle/10234/154485>

*The European Commission support for the production of this publication does not constitute an endorsement of the contents which reflects the views only of the authors, and the Commission cannot be held responsible for any use which may be made of the information contained therein.*

## TABLE OF CONTENTS

Case studies summary .....	6
Case study 1. The role of biomass at GAIA Ecovillage, and its utilization in establishing new eco-houses .....	12
Case study 2. Photovoltaic - wind hybrid system for energy supply of an isolated consumer .....	150
Case study 3. Study concerning optimization of photovoltaic lighting system in Margineni village .....	270
Case study 4. Development of renewable energy models for children education .....	338
Case study 5. Agricultural biomass production for bioenergy in integrated RE systems of small agricultural enterprises .....	470
Case study 6. Differences between 2 PV systems in irrigation .....	534



Co-funded by the  
Erasmus+ Programme  
of the European Union

# Compilation of case studies of applying renewable energies to local development transnationally implemented

Castelló de la Plana, july 2017



**Compilation of case studies of applying renewable energies to local development transnationally implemented**



Co-funded by the  
Erasmus+ Programme  
of the European Union



## Content:

<b>Case study 1 - Javier Castelló (UJI)</b>	
<b>Case study tutor</b>	Noémi Fiser (Paco Colomer @ UJI for internal issues)
<b>Renewable tutor</b>	Csaba Patkós - GEOLIN
<b>Rural development tutor</b>	Vicent Querol
<b>English tutor</b>	Noémi Fiser
<b>SME Supervisor</b>	Sándor Némethy/Csaba Patkós
<b>Project/case study title</b>	The role of biomass at GAIA Eco-village, and its utilization in the process of organic food production
<b>Project/case study summary</b>	The use of biomass in heating system is beneficial because it uses agricultural, forest and industrial residues and waste to produce heat with less effect on the environment than fossil fuels. The case study focuses on how biomass is used for heating at Gaia Ecovillage. What are the advantages and disadvantages of using biomass. What kinds of system, equipment are needed for heating new eco-houses. Cost comparison of energy sources, return on investment calculations are needed in case of installing the new equipment.

<b>Case study 2 - Mario Muñoz (UJI)</b>	
<b>Case study tutor</b>	Grigore Roxana/Puiu Gabriel (Hector Beltran @ UJI for internal issues)
<b>Renewable tutor</b>	Jose Segarra Murria - UMANS
<b>Rural development tutor</b>	Vicent Querol
<b>English tutor</b>	Noémi Fiser
<b>SME Supervisor</b>	Valerica Rusu/Laurențiu Măgureanu
<b>Project/case study title</b>	Photovoltaic - wind hybrid system for energy supply of an isolated consumer.
<b>Project/case study summary</b>	The main objective of the following case study is to design a hybrid system (PV+Wind) for an isolated consumer located in the village of Călugăreni (Romania). Other options like a mix between photovoltaic solar panel and grid connection power supply system are discarded due to the huge amount of money the proper grid connection would cost. A criteria will be followed when choosing the final solution in order to give the best possible result to the consumer. This project will be limited to the design of the system, so aspects like O&M, construction methods, legislation, etc. will be briefly explained or just mentioned.

<b>Case study 3 - Dóra Okos (EKU)</b>	
<b>Case study tutor</b>	Grigore Roxana/Puiu Gabriel
<b>Renewable tutor</b>	Jose Segarra Murria - UMANS
<b>Rural development tutor</b>	Vicent Querol
<b>English tutor</b>	Csaba Szűcs
<b>SME Supervisor</b>	Valerica Rusu/Laurențiu Măgureanu
<b>Project/case study title</b>	Study concerning optimization of photovoltaic lighting system in Margineni village
<b>Project/case study summary</b>	<p>In Margineni village works a photovoltaic lighting system with LED lamps since almost 2 years.</p> <p>In the current solution: each lighting pole is a standalone system. The aim of my study: to design a centrally managed system for a street where no public lighting now. I design a new system what supply power to the public lighting by solar energy with an intelligent controller, what name is dimmer.</p> <p>This development will be able to optimize the energy flow, thus minimizing the cost of energy consumed by the lighting system</p> <p>In my case study, I need to analyze the current solution to choose the best opportunity for the development.</p> <p>Some advantages of the central control:</p> <ul style="list-style-type: none"> <li>- Modernization , comfortable solution</li> <li>- All systems check up at the same time</li> <li>- If necessary, easy and quick intervention to each system</li> </ul> <p>This modernization would be further improvements to the village.</p>

<b>Case study 4 - Vivien Balog (EKU)</b>	
<b>Case study tutor</b>	Carmen Ibáñez Usach
<b>Renewable tutor</b>	Jose Segarra Murria - UMANS
<b>Rural development tutor</b>	Vicent Querol
<b>English tutor</b>	Imre Baják
<b>SME Supervisor</b>	Zsuzsanna Kray
<b>Project/case study title</b>	Development of renewable energy models for children education
<b>Project/case study summary</b>	<p>This case study focuses on children education on renewable energies. It is very important to inform kids about renewable energy sources since the future generations will be who decide which types of energy employ, will be who develop new energy plants and, in the end, will be</p>

	<p>who set the direction of future society.</p> <p>In order to make children aware about the relevance of using renewable energies, the use of models could be a fantastic way of teaching. This is even more important in rural areas, where the employment of these energies could create new ways of development, and, at the same time, protect the environment.</p> <p>Therefore, for this purpose, in this case study three models will be designed and their respective pedagogical guides will be prepared.</p> <p>Firstly, three different types of models will be analysed: eolic energy, photovoltaic energy and hydraulic energy, each of them focused on a type of energy transformation process. For each model selected from the literature reviewed, different features will be presented and studied: an initial design of each model will be included, the materials and components needed will be listed, a description of the process will be done and, finally, the steps to build it will be explained.</p> <p>From this analysis, the advantages and disadvantages of each model will be extracted and, subsequently, conclusions about the design of the three new models will be drawn. Taking into account the results of this initial research, the design of the new models will be accomplished together with their corresponding pedagogical guides and budgets.</p>
--	--

<b>Case study 5 - Atena Georgiana MOUHANNA (UB)</b>	
<b>Case study tutor</b>	Csaba Szűcs
<b>Renewable tutor</b>	Csaba Patkós - GEOLIN
<b>Rural development tutor</b>	Vicent Querol
<b>English tutor</b>	Csaba Szűcs
<b>SME Supervisor</b>	Sándor Némethy/Csaba Patkós
<b>Project/case study title</b>	Agricultural biomass production for bioenergy in integrated RE systems of small agricultural enterprises.
<b>Project/case study summary</b>	This project is conceived to analyse the different biomass technologies that could be used to produce energy at an agricultural enterprise. Beyond the biomass resources review and the analysis of the different technologies, which allows extracting the advantages and disadvantages of each technology and, subsequently, conclusions about them, the project is completed with the design of a biomass boiler and the design of the biomass heating system. Finally, the study introduces the impact of the project for the rural development and provides some conclusions on the potential usage of this type of solutions.



<b>Case study 6 - Corneliu Zediu (UB)</b>	
<b>Case study tutor</b>	Lluis Monjo
<b>Renewable tutor</b>	Jose Segarra Murria - UMANS
<b>Rural development tutor</b>	Vicent Querol
<b>English tutor</b>	Csaba Szűcs
<b>SME Supervisor</b>	Zsuzsanna Kray
<b>Project/case study title</b>	Differences between 2 PV systems in irrigation
<b>Project/case study summary</b>	<p>The goal of the project is to enhance my knowledge in Renewable Energy, in special in Photovoltaic Solar Energy by showing a comparison of 3 systems of Photovoltaic panels that provides energy to an underground pump:</p> <ul style="list-style-type: none"> <li>- PV cells with fixed support and without batteries;</li> <li>- PV cells with fixed support and batteries;</li> <li>- PV cells with solar tracking system and batteries.</li> </ul> <p>Hours of running of the pump: 5 hours.</p> <p>Location of the project is a rural environment situated near to Jerica, Castellon, Spain</p> <p>This project is going to include technical data for all the options in accordance with the particularities of the environment and also the economical calculation for the most efficient system.</p>





**Compilation of case studies of applying renewable energies to local  
development transnationally implemented**



Co-funded by the  
Erasmus+ Programme  
of the European Union

REPORT OF THE CASE STUDY ON RENEWABLE ENERGIES TO LOCAL  
DEVELOPMENT TRANSNATIONALLY IMPLEMENTED

# The role of biomass at GAIA Ecovillage, and its utilization in establishing new eco-houses

Javi Castello Mollar  
Universitat Jaume I  
al241022@uji.es

Case Study Tutor: Noémi Fiser  
Renewable energies tutor: Csaba Patkós  
Rural development tutor: Vicent Querol  
English tutor: Noémi Fiser  
Professional supervisor: Sándor Némethy/Csaba Patkós  
GAIA Foundation  
Gyöngyös (Hungary), April 2017



**Compilation of case studies of applying renewable energies to local  
development nationally & transnationally implemented**



Co-funded by the  
Erasmus+ Programme  
of the European Union



## Summary

This study details the implementation of a biomass boiler obtained from energy crops to produce thermal energy through radiant floor in 11 houses of the left wing of a building of a village isolated from the population in Galgahévíz (Hungary) as an alternative renewable energy. It is an installation to complement the other energies already available.

In the first part of the project, we will deeply study the concept of biomass, including a compilation of data on the types that exist, the forms of conversion in energy, their characteristics. A study will also be carried out to obtain the possibilities and the situation of the biomass within the ecovillage, giving alternatives to possible problems.

Alternatives to this biomass boiler will be studied, and analyzed one by one, to rule out possible better alternatives.

Once placed in situation, we will perform the calculations to obtain the thermal energy demand of the building for the dimensioning of the mentioned plant, where we will analyze all the necessary aspects for the correct dimensioning using different multicriteria studies to decide both the size of the plant and the location.

Afterwards, a study will be carried out to determine the needs of energy crops, selecting the best species for this climatic zone, the cultural actions to be carried out over the next 20 years.

Finally we will carry out the economic feasibility study of the plant in function of the current regulations.



**Compilation of case studies of applying renewable energies to local  
development transnationally implemented**



Co-funded by the  
Erasmus+ Programme  
of the European Union

## Contents of the project

<b>Memory of the project .....</b>	<b>9</b>
1 Introduction to the project.....	11
2. State-of-art in the problem domain .....	12
3. GAIA eco-village .....	13
3.1 Localization.....	14
3.2 Background .....	15
3.3 Available resources.....	15
4. Biomass.....	16
4.1 Definition .....	16
4.2 Biomass situation analysis .....	17
4.2.1 Global Context.....	17
4.2.2 Context Europe .....	18
4.2.3 Situation Hungary .....	21
4.3 Obtaining sources .....	23
4.4 Biomass Advantages .....	24
4.5 Energy use .....	24
4.6 Parameters to value biomass quality .....	25
5. Current installation .....	26
5.1 Description of the village .....	26
5.2 Description of the current installation.....	28
5.3 Description buildings construction.....	30
6. Design alternatives to be considered .....	37
6.1 Power source .....	37
6.2 System obtaining heat .....	38
7. Description of the final solution .....	40
7.1 Biomass boiler.....	41
7.1.1 Strengths .....	41



7.1.1 Weaknesses .....	42
7.2 Radiating floor.....	42
7.2.1 Strengths .....	43
7.2.1 Weaknesses .....	43
8. Sources of biomass available .....	44
9. Energy crops .....	45
9.1 Types of land .....	46
9.2 Selected species.....	46
9.3 Operations to be carried out after planting .....	48
9.3.1 Planting time .....	48
9.3.2 Control of weed .....	48
9.3.3 Replenishment of trees.....	50
9.3.4 Fertilization.....	51
9.3.5 Irrigation .....	52
9.4 Control of biotic and abiotic damages .....	53
10. Process of obtaining the biomass.....	59
10.1 Pruning .....	59
10.2 Harvest .....	60
10.3 Transportation.....	61
10.4 Process in the plant.....	61
10.5 Biomass Storage.....	61
10.6 Biomass drying.....	62
11. Impact of the project for the rural development .....	63
11.1 Environmental impact .....	64
11.2 Social and rural impact.....	65
12. Conclusions .....	66
13. References .....	67
<b>Calculations and design .....</b>	<b>69</b>
1. Introduction.....	71
2. External climatic conditions of calculation .....	71
2.1 Latitude, longitude and altitude.....	71

2.2 Dry temperature and humidity .....	72
2.3 Percentile level .....	72
2.4 Temperatures and humidity .....	73
2.5 Temperature oscillations.....	73
2.6 Radiation data.....	73
2.7 Intensity and direction of prevailing winds.....	74
3. Internal conditions of calculation .....	75
3.1 Temperature.....	75
3.2 Humidity.....	75
3.3 Noise and vibration .....	76
4. Coefficients of heat transfer of the building elements .....	76
4.1 Composition of the constructive elements .....	76
5. Calculation of thermal charge.....	79
5.1 Building description .....	79
5.2 Calculation of thermal loads of the village .....	80
6. Calculation of underfloor heating .....	93
6.1 Initial data.....	93
6.2 Calculation of specific heat .....	93
6.3 Calculation of linear meters .....	94
6.4 Calculation of the flow .....	95
7. Calculation of available biomass .....	97
7.1 Planting.....	97
7.2 Distance and density planting .....	98
7.3 Pruning .....	99
7.4 Biomass .....	101
7.5 Viability.....	102
8. Elements of the machine room .....	102
8.1 Dimensions.....	102
8.2 Inertia tank.....	103
8.3 Boiler.....	108
8.4 Pumps.....	109



8.4.1 Loss pump-building .....	111
8.4.2 Loss of manifold .....	112
8.4.3 Loss of height.....	113
8.4.4 Pump selection .....	114
8.4.5 Power calculation.....	116
8.5 Smoke evacuation.....	116
8.6 Ventilation.....	117
<b>Budget and economic analysis.....</b>	<b>119</b>
1. Economical aspects of the project .....	121
2. Budget of the installation .....	121
2.1 Direct costs .....	121
2.1.1 Elements of the machine room .....	121
2.1.2 Radiating floor .....	122
2.1.3 Energy crops .....	123
2.2 Indirect costs .....	124
2.5 Summary .....	125
3. Payback, IRR and NPV .....	126
<b>Project plans .....</b>	<b>129</b>



# Memory of the project



**Compilation of case studies of applying renewable energies to local  
development nationally & transnationally implemented**



Co-funded by the  
Erasmus+ Programme  
of the European Union



## 1 Introduction to the project

This project includes all the details of a holistic rural development program in a town near the capital of Hungary, Budapest. The vast majority of rural communities in Hungary earn their livelihoods through agriculture, which is closely linked to food production, waste management and water management. The majority of people with energy poverty live in rural areas and depend on agriculture as the only way of subsistence, but very often they cannot cover the energy needed to produce their own agricultural production. Therefore the objective of this work is the construction of renewable energy sources, with minimum or zero residues adapted to local conditions and needs. Self-sustaining rural economies and village communities may be the best solution for many people, incorporating the production and sustainable use of renewable energy resources and food production, introducing energy-efficient construction technologies based on natural materials. With a socially cohesive and environmentally conscious development provide safe living conditions for all.

The objective of this document is to obtain a diagnosis, as effective as possible, of the current situation of the use of biomass from different sources in rural areas of Hungary, and the feasibility study of this type of renewable energy in the ecovillage of the Foundation. The case study focuses on the use of biomass for heating purposes in Gaia Ecovillage. What are the advantages and disadvantages of using biomass? What kind of system, equipment are needed to heat new eco-houses. The comparison of costs of energy sources, return-on-investment calculations are necessary in case of installing new equipment, materials of new constructions, etc.

## 2. State-of-art in the problem domain

Hungary has a population of 9,830,485 people, who live in rural areas, and some of these rural areas do not have a connection to the electricity grid, and the livelihood of these people is closely connected with agriculture. It means that the inhabitants of these areas are linked to their own food production, waste management and water management. Many of these people are energetically poor, their only way of life is agriculture to produce the food they consume, but the problem is, that in many occasions they cannot cover enough energy required for their own agricultural production, and much less to meet the energy needs.

These rural areas disconnected from the electricity grid do not have any type of alternative for the production of energy, neither thermal nor electric, and a lot less the enough money to be able to think about the implantation of solar panel, or small windmills, etc., to produce their own necessary energy, which would allow them to be able to improve their quality of life, at the same time that it would obtain growth respectful with the environment.

To all this we add that Hungary [Figure 1] is situated between the latitudes of  $45^{\circ} 45'N$  and  $48^{\circ} 35'N$ , approximately halfway between the Equator and the North Pole, i.e. according to the location, Hungary is located in the temperate climate zone. Its climate is very erratic, and one of the main reasons for this is the fact that Hungary is located between 3 climatic zones, due to this there are great differences in the climate of the country, despite its lower altitudes and relatively small extent, so that during the winter great frost is reached, especially in the north of the country, to achieve a comfortable life, buildings are needed with thermal power supply during these winter periods.



Figure 1 - Location of hungary in europe

All these reasons are summarized in that the majority of people in the rural areas are energetically poor, and have high thermal energy needs because of the great frosts that occur in these latitudes during the winter periods, but the economy and knowledge prevent to take the step to the renewable energies, obtaining thus a growth in its quality of life linked to the care of the rural environment and of agriculture, since it is its means of life.

### 3. GAIA eco-village

Foundation Gaia is a non-governmental organization (NGO) founded in 1990 by a group of friends with very clear ideas, to face the consumerism established by the society of these times. The objective is to create a more sustainable and environmentally friendly model of life, in order to revive biocultural diversity, regenerate healthy food and ecosystems, improve community ecological governance, halt climate change and challenge corporate dominance. The Gaia Foundation has projects spread all over the world and works with local and indigenous communities, civil society groups and social movements to re-establish a respectful relationship with the Earth.

The name was taken from the word Mother Earth of Greek mythology, the main mission of the Gaia Foundation focuses on the interconnection of all things and the life on earth, and around work for harmony and social justice and environment for living beings. Humans are included in the equation. Therefore, Gaia is not just an environmental organization, but a "whole Earth" organization.

Among many projects, Gaia Foundation began to create an eco-village in Hungary in 1992 with the values that characterize them, and with which they started years ago, a project to create a space to live on their own, and to demonstrate to the Society, that another approach to life is possible. Another project that Foundation GAIA has in Hungary is Galgafarm, a farm with those philosophical aspects, where waste is managed to minimize them, reuse them, and generate energy for food production with its subsequent economic benefit.

As a conclusion, the Foundation has a clear slogan "Consciousness, Responsibility, Action" and is the one that tries to expand and share with its numerous projects that are going on all over the world.



### 3.1 Localization

Gaia Eco-village is located in the north of the country, it is 3 km far away from Galgahévíz, (45 km far away from the capital, Budapest), at the foot of the Gödöllői Protected Landscape Area, on the shores of Lake Bika. Galgahévíz is a village a bit different from the rest of Hungary, because it was a desert village, and was restored by the inhabitants of Galgahévíz, who are conscious of the environment, and they try to reflect their commitment to ecological values.



Figure 2 - Location of the village in Hungary

It is a completely rural enclave in the middle of the mountain, can only be accessed by dirt roads, in the winter periods there is the possibility of being cut off by the snowstorms, and next to a fairly large lake where different aquatic activities can be done.

This place provides everything you could want from a village of these characteristics, far from civilization, close to nature, with very fertile land and a water spring of 130 meters deep.

### 3.2 Background

The Gaia Foundation was founded in 1990 by a group of friends, who remain the original support of the ideological goal. This ideological goal is to create a living space for themselves, which demonstrates that another approach to life is obviously possible with its strengths and threats. This village has been taking shape since 1992, when Galgafarm Cooperation was created, very close to the village itself, where agricultural and food processing activities are carried out, a Training Center, a hotel and a restaurant were also built in 1997. There was a great change from 2006, when they began to build houses to attract more public into the ecological town, and to continue with the diffusion of their philosophy of life. Six years later, in 2012, a demonstration center was created, where they want to convey all the experience and knowledge that they have acquired during the journey towards the more sustainable academic and practical sustainability, because they are convinced themselves, as well, that it is capable to translate outside the village. Therefore a center of reference became in the same year, which was recognized by different institutions of the European Union, to develop a university level eco-village designers and study plans.

This place is built with an integrated design to achieve total self-management, from the generation of its own electricity, production of its food, self-management of water and re-use of its own waste, since the founders of the eco-village recognized that the current economic growth is limited, and cannot be maintained so long, it is not sustainable. This is the reason, why this village operates in a different way from the others. The aspects of sustainability are taken very seriously, people live according to them, and try to leave the smallest carbon footprint behind.

### 3.3 Available resources

As it has been mentioned above, the village is situated in a rural, wooded, fertile land and near to Lake Bika of considerable dimensions, so it provides everything which is necessary for having a self-sufficient life.

Hungary in general is a very windy area, this provides good characteristics for the production of electric energy by wind turbines. In its plots there are two types of already installed, as well as the different photovoltaic solar panels that are located on the roofs of the common buildings of the village. Therefore the electrical energy would be more than covered. This installation is detailed further in section 5.2.

If we talk about thermal energy, in these common buildings solar thermal panels and biomass boilers are installed, as the village has large tracts of land on its property to exploit them and extract all the biomass needed to supply the different buildings, in this exploitation will focus the study on.

At a depth of 130 meters under the soil of the eco-village there is a natural spring, from where water is extracted for domestic use. The water already used coming from the houses is managed for different uses as the irrigation of the fields.

Residents also have a small greenhouse used for the principles of permaculture, explained in more details in section 5.1, to be able to harvest food, since as previously said, the lands are rather fertile and are optimal for this activity.

This means that the location is practically perfect as the autonomy of the eco-village is complete.

#### **4. Biomass**

The use of biomass is linked to the existence of the human being on Earth, about 500,000 years ago fire was the first great invention of mankind, which primitive man used for warming during the Paleolithic winters, in our era of the Homo sapiens was able to formally dominate the nuclear energy, the main source of energy was biomass.

The firewood was from the domestication of fire until the middle of the nineteenth century the main source of energy, its substitution by coal produced at the end of the XIX the decisive industrial revolution in the field of technology. The carbon is replaced by oil, which is also formed by fossilized organic waste, but in one case as in the other, because the resources are of a limited nature, the possibilities of exploitation are closer to their end, This together with the risks of nuclear energy, not only for man and nations, but for the ecological balance of the planet, too, obliges to put the eye on the use of new technologies that allow a better use of the first energy used by man, biomass.

##### **4.1 Definition**

The energy of biomass, the only vital energy of the planet Earth, has its origin in photosynthesis. Through this process, plants transform energy from the sun into chemical energy by storing it in their cells as carbohydrates.

The energy stored by the plants is transmitted to the herbivorous animals and these to the consumers of second degree or carnivorous (where the human beings are) and is maintained, although modifies, in the residues that these produce. Organic matter from plants and animals that feed on them and can be converted into useful energy is what is known as biomass.

This energy stored by plants can be released by subjecting it to different processes of energy utilization.

## **4.2 Biomass situation analysis**

### **4.2.1 Global Context**

The development and operation of existing production and consumption systems require large amounts of energy to sustain themselves. That is why poor countries have nowadays a low energy consumption, while the energy consumption of rich countries is several times higher than before, even though their processes are much more efficient and there are important awareness campaigns for energy saving.

This means that the development of a country implies a considerable increase in its energy consumption. This situation can be verified in the measure that the increase of the energy consumption of the developing countries is analyzed. The International Energy Agency has developed various biomass projects through its IEA Bioenergy division. This agency estimates that 10% of the world's primary energy comes from resources associated with this source, including those related to liquid biofuels and biogas.

A large part of this percentage corresponds to the poor and developing countries, where it is the most used raw material for energy production, just in those countries where a greater increase in energy demand is expected. According to the data of the United Nations Food and Agriculture Organization (FAO), "some poor countries get 90 percent of their energy from fuelwood and other biofuels."

In Africa, Asia and Latin America it accounts for a third of energy consumption and for 2 billion people is the main source of energy in the domestic sphere. But in many cases, this massive use is not achieved through a rational and sustainable use of resources, but rather as a desperate search for energy that causes deforestation of large areas, leaving the soil defenseless against erosion.

The FAO itself recognizes that “ improving the efficient use of biomass energy resources - including agricultural wastes and planting of energy materials - offers employment opportunities, environmental benefits and better rural infrastructures". It goes even further by considering that the efficient use of these energy sources would help to achieve two of the millennium development goals: "eradicate poverty and hunger and ensure environmental sustainability."

Returning to the beginning, biomass could be the energy vector that would allow the development of poor countries, avoiding that the increase of the energy consumption associated to this development would endanger the environment and the security of energy supply of our society.

#### 4.2.2 Context Europe

The situation of solid biomass at European level, mainly wood energy, which is still largely governed by heating requirements, and these requirements are climate-dependent. During 2015 according to EurObserv'ER, there was a rebound in solid biomass consumption as a consequence that the winter of this same year was not as smooth across the continent as the previous one. Leaving aside climatic variations, the use of solid biomass to produce heat or electricity has tended to increase in the European Union. The highest consumption quota of 93.8 Mtoe was recorded in 2015, an increase of 3.8 Mtoe compared to 2014, due to the impetus of the European support policies and the increase of the awareness of the population by this type of energy.

In the European Union of the 28, solid biomass is by far the main renewable energy source, and in the rest of the world too, in 2014, according to Eurostat, I represent half of all renewable energy consumption, a total of 93.8 Mtoe [Table 1] 201.2 Mtoe.

During the first decade of the millennium, solid biomass consumption in the EU of the 28 increased steadily. But this was slowed down a few years ago, since 2010, where the growth of solid biomass consumption as primary energy has slowed, this is due to the atypical climatic

Country	2014		2015*	
	Production	Consumption	Production	Consumption
Germany	11.437	11.417	12.062	12.062
France**	9.074	9.074	9.559	9.559
Sweden	8.923	8.923	9.129	9.129
Italy	6.539	8.066	6.712	8.357
Finland	8.137	8.137	7.901	7.927
Poland	6.179	6.755	6.268	6.774
United Kingdom	3.165	4.885	3.824	6.097
Spain	5.161	5.276	5.260	5.260
Austria	4.227	4.361	4.473	4.573
Romania	3.646	3.618	3.700	3.620
Czech Republic	2.842	2.763	2.954	2.874
Denmark	1.308	2.351	1.590	2.532
Portugal	2.671	2.351	2.603	2.340
Belgium	1.104	1.689	1.166	1.937
Hungary	1.403	1.390	1.414	1.457
Latvia	2.047	1.337	2.008	1.257
Lithuania	1.117	1.084	1.205	1.204
Croatia	1.375	1.093	1.470	1.200
Netherlands	1.290	1.147	1.364	1.179
Greece	0.869	0.930	0.952	1.023
Bulgaria	1.087	0.992	1.100	1.000
Estonia	1.122	0.789	1.209	0.825
Slovakia	0.759	0.752	0.734	0.734
Slovenia	0.533	0.533	0.590	0.590
Ireland	0.210	0.252	0.201	0.228
Luxembourg	0.060	0.059	0.050	0.059
Cyprus	0.009	0.012	0.010	0.012
Malta	0.001	0.001	0.001	0.001
European Union	110.252	110.035	114.014	113.793

Table 1 Biomass production and gross inland consumption of solid biomass in the European Union in 2014 and 2015

conditions of these years, such as the hurricanes of 2011 and 2014, because these phenomena triggers an increase in heating needs and, subsequently, household consumption of wood. However, despite changing climatic conditions, the general trend over time is that the consumption of solid biomass increases, for either of its two uses, heat or electricity. The figure that determines this constant impact, marks the year 2015, although this year is one of the hottest years recorded before, was not as mild in the whole European Union as it was in 2014 (with local exceptions like Finland) and reached 93.8 Mtoe in 2015, breaking its previous consumption record in 2013 (Graph 1).

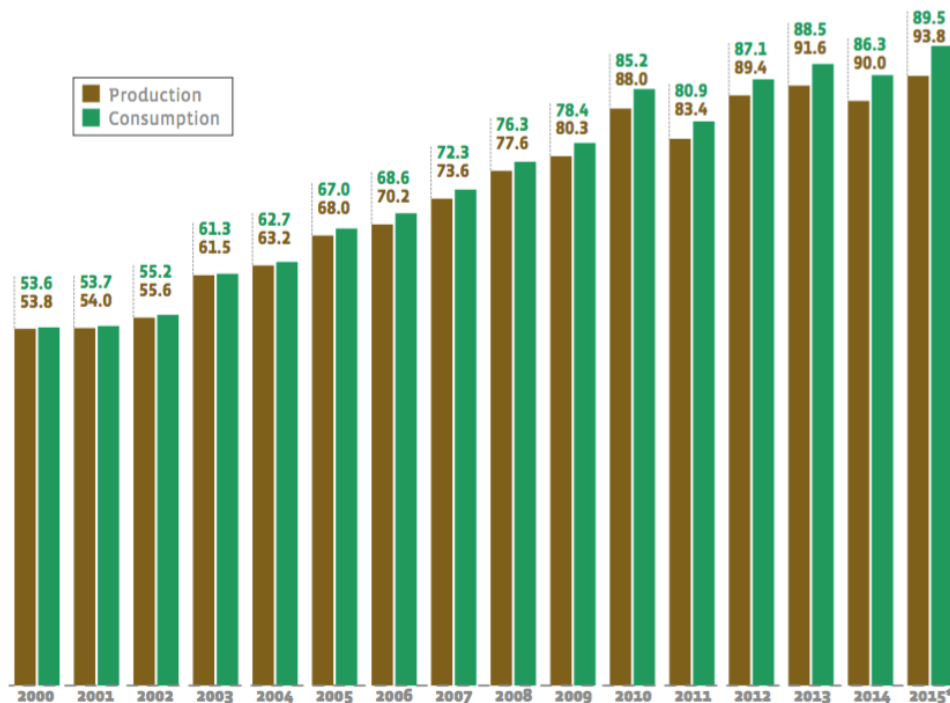

Graph 1 - Solid biomass primary energy production and inland consumption growth figure for the UE since 2000 (in Mtoe)

If we refer only to solid biomass coming from only European Union soil, it also increased slightly with respect to previous years and reached 89.5 Mtoe [Table 1]. Year after year, the difference also increased between net imports, for example in recent years from 2.3 Mtoe in 2012 to 4.3 Mtoe in 2015 is likely to be attributable to higher imports of North American wood pellets, for the increase of this energy also there, mentioned in the section 4.2.1 in more details.

In Table 2 of EurObserv'er, separate the uses of the final energy, electricity and heat, coming from the solid biomass. The European Union's solid biomass electricity production is less sensitive to climate change and is governed more by the policies of a few Member States to develop biomass, either by converting old coal-fired power plants or by biomass cogeneration.

Country	2014			2015		
	Electricity only plants	CHP Plants	Total electricity	Electricity only plants	CHP Plants	Total electricity
United Kingdom	13.852	0.000	13.852	19.418	0.000	19.418
Germany	5.300	6.500	11.800	4.800	6.200	11.000
Finland	1.073	9.894	10.967	1.217	9.372	10.588
Poland	0.000	9.161	9.161	0.000	9.027	9.027
Sweden	0.000	9.007	9.007	0.000	8.977	8.977
Spain	2.856	0.965	3.821	3.126	0.888	4.014
Italy	2.011	1.739	3.750	2.077	1.786	3.862
Belgium	1.388	1.244	2.632	2.298	1.256	3.554
Austria	1.109	2.332	3.440	1.232	2.264	3.497
Denmark	0.000	2.959	2.959	0.000	2.803	2.803
Portugal	0.765	1.765	2.530	0.795	1.723	2.518
France**	0.095	1.543	1.637	0.098	2.042	2.140
Czech Republic	0.054	1.938	1.992	0.049	2.042	2.091
Netherlands	1.436	0.662	2.099	1.724	0.173	1.897
Hungary	1.537	0.165	1.702	1.540	0.173	1.713
Slovakia	0.011	0.905	0.916	0.011	0.842	0.853
Estonia	0.061	0.670	0.731	0.069	0.641	0.710
Romania	0.237	0.217	0.454	0.237	0.217	0.454
Latvia	0.002	0.317	0.319	0.000	0.378	0.378
Lithuania	0.000	0.293	0.293	0.000	0.318	0.318
Ireland	0.251	0.014	0.265	0.184	0.013	0.197
Bulgaria	0.010	0.128	0.138	0.010	0.128	0.138
Slovenia	0.000	0.125	0.125	0.000	0.131	0.131
Croatia	0.000	0.050	0.050	0.000	0.050	0.050
Luxembourg	0.000	0.021	0.021	0.000	0.024	0.024
Greece	0.000	0.000	0.000	0.002	0.000	0.002
<b>European Union</b>	<b>32.047</b>	<b>52.612</b>	<b>84.659</b>	<b>38.886</b>	<b>51.467</b>	<b>90.353</b>

Table 2 -Gross electricity production from solid biomass in the European Union in 2014 and 2015 (in TWh)

Summing up at EU level, biomass electricity production increased by 6.7% (5.7 TWh) in 2014 to 90.4 TWh in 2015. However, it can be misleading because in the last three years the United Kingdom has been the main driving force behind the increase of the solid biomass of the European Union in the use of electricity. Its production increased by 5.6 TWh between 2014 and 2015 and by 9.6 TWh between 2013 and 2015. Growth in other countries has been

more uneven with increases in 2015, for example the most prominent, in Belgium (0.9 TWh between 2014 and 2015) in Germany (0.8 TWh) Finland (0.4 TWh), France (0.5 TWh), Denmark (0.2 TWh).

#### 4.2.3 Situation Hungary

Renewable energy sources used mainly in Hungary for the production of electricity and heat, as well as their use as fuel, in data of 2014 two thirds of the use of this energy is for heating and cooling, 17% electricity and another 17% of the energy used in the transport sector. On the basis of national endowments, solar energy and the use of geothermal energy will continue to play a prominent role. Geothermal energy especially since this country has a perfect geography and geology to be able to extract the heat easily from the earth's surface.

In 2014 the share of renewable energy in Hungary in gross final consumption of energy increased by 9.51 per cent, according to the Eurostat database, far exceeding the original target of 8 per cent target for the year. Statistics show that the country figures in the 2010 calendar outdated, which is on track to reach the Europe 2020 targets.

According to the national energy strategy associated with the European Union's National Action Plan for Renewable Energy in 2020, the target is to reach this year a rate of 14.65% of the gross final consumption should be of renewable energy. The obstacles to be saved to reach this goal is the development of the national economy and the thinking of the local community.

If we speak more specifically of biomass, its production stabilized between 2014 and 2015, since its production only increased very slightly, 0.1TWh [Table 2] is generated mainly by the traditional agricultural production sectors of agriculture and forestry, by-products and forest residues, and the production of crops for energy purposes (energy crops). The use of these resources in this country has realistic opportunities.

Throughout the country, the primary energy managed volume is 1,414 Mtoe and gross domestic consumption of solid biomass around 1,457 Mtoe, according to Eurobserv'er data from December 2016 [Table 2], relatively this value is not very high compared to other countries because their size is quite small, but if we calculate per capita percentage, the results show that Hungary is almost at the EU average of biomass consumption per capita [Graph 2].



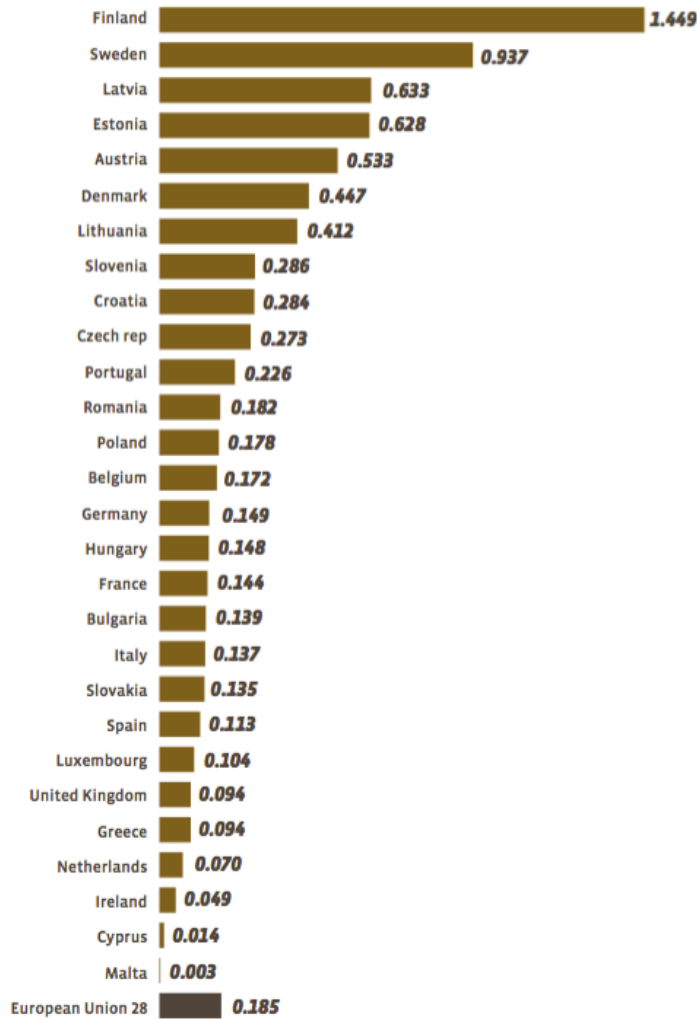

Graph 2 -Gross energy consumption of solid biomass in toe per inhab in the European Union in 2015

The distribution of electricity produced in this country in 2015. According to Eurostat data are the following:

Nuclear energy	Lignite and coal	Hydrocarbons	Renewable sources
52,7 %	19,9 %	17,4 %	10 %

Therefore, we observe that biomass is a very small source within the global compute of all the energies that are used, even so, within renewable energies, it is one of the most used in conjunction with solar.

### 4.3 Obtaining sources

There are different types of biomass that can be used as an energy resource. Although a multitude of classifications can be made, this study has chosen a more accepted classification, which divides the biomass into three different types: natural, residual biomass, in which it is subdivided into dry and wet residual, and energy crops.

- Natural biomass, which is the only one produced in nature without any human intervention. The problem that presents this type of biomass is the necessary management of the acquisition and transport of the resource to the place of use. This can cause the exploitation of this biomass economically and ecologically unfeasible.

- Biomasa residual, within this group is the biomass;

Agricultural; In this first group are all products from the remains of the inhabitants' own crops, and pruning rests. Agricultural surpluses not used for human consumption can be used, for example, for the production of liquid biofuels.

Cattle remains; Manure, offal or waste from agricultural and agri-food activities.

Urban; Biodegradable fractions of urban waste can be used inter alia to make liquid biofuels.

Forest; This group is considered to all the products and remains that come from work of maintenance and improvement of the fields.

- Biomass produced; Energy crops are fields of cultivation with the sole purpose of producing biomass that can be converted into fuel for energy use. Energy farms can supply a large percentage of the world's energy requirements while at the same time revitalizing rural economies, providing energy independently and safely and achieving significant environmental benefits. Nevertheless, its development in Spain is very slow comparing it with countries like Sweden, Finland, Austria. Large tracts of land are needed to achieve cost-effective energy production

#### 4.4 Biomass Advantages

The use of biomass as renewable energy versus non-renewable energy, such as fossil fuels, has the following advantages:

- It does not contribute to the greenhouse effect.
- Reduce sulfur emissions.
- Reduce the emissions of particles.
- Reduces CO, HC and NO<sub>x</sub> emissions
- Cycle neutral CO<sub>2</sub>.
- Possibility of using fallow land with energy crops.
- Providing agricultural waste, avoiding its burning in the field.
- Reduces energy dependence with non-renewable fossil energies.
- Reduction of the hazards associated with fuels derived from petroleum.
- Reducing risks from forest fires and insect pests
- Socioeconomic growth in rural areas

With these advantages, biomass in the future will be a source of potential energy, being an element of great importance in rural areas, as nowadays in Hungary.

#### 4.5 Energy use

The heat that of the solid biomass differs in turn by the direct use to which it arrives, three main uses are evidenced;

- Thermal, stands out for being the most efficient and is subclassified in two according to its purpose of use;

Industrial, if the heat produced goes to industrial processes

Domestic, heat and water in stoves and boilers for domestic use

- Electric, from a boiler we generate steam at high pressure that spins a turbine and this an alternator to produce electricity, this purpose is the one that most contribute to rural development.

-Co-Combustion, replacing part of a fossil fuel such as carbon by biomass to reduce pollutant emissions.

#### 4.6 Parameters to value biomass quality

The main technical parameters to determine the quality of the biomass are;

- Humidity, i.e. the amount of water in biofuel, has a decisive impact on the available energy of each biofuel. Usually, two methods are used referring to the dry product and referred to the wet product to establish the moisture content, according to the procedure used to account for the mass of water. It is important to distinguish them, especially when the moisture content is high. This will determine the calorific power and performance.
- Granulometry, it is the distribution of the particle sizes of the biomass, and this will be linked to the technology of exploitation, the lower particle size greater energy consumption. Not all the boilers accept a certain granulometry and to arrive at a determined granulometry it is necessary to treat the biomass by means of machinery (crushing and mill) but this increases the price considerably.
- Ashes, especially at the domestic level as it is in the ecovillage are an important parameter, are directly linked to the nature of the type of biomass being used and related to the management (or mismanagement)
- Density, is the amount of dry biomass present per unit volume of wet material and will determine transport costs and their efficiency.

## 5. Current installation

### 5.1 Description of the village

As previously described in order to arrive the eco-village, it is necessary travel 3km by a dirt road from Galgahévíz. It is possible to define two different zones, a built area where the individual and common buildings are located and another area is much more extensive that surrounds the previous one where the extensions of the field of the Foundation are located [Figure 3].



Figure 3 - Aerial view of the village

Within the built area there is;

- A total of 10 individual houses inhabited scattered in this area, are not connected to each other but if close enough, each has an underground connection of electricity and pipe to the water management system. They are houses of no more than a height, with gabled roof to avoid accumulation of snow in winter times.
- In the center of the built area is the main building [Figure 4], the largest of all, with a semicircular and symmetrical shape, and with an extension of 101 meters long, 17 meters wide, with two floors and a gabled roof, but in the center has a high dome reaching to surpass the 17 meters of height. This building is designed to house in 20 smaller premises for 16

owners, not equal between them, with small differences, of which they are only built and inhabited 7 [Plan 3 and 4].



Figure 4 - Main building

- In the areas a little farther away, there is a building constructed by permaculture, this means that it is designed by a sustainable architecture based on the patterns and characteristics of the natural ecosystem. There are animals and a small greenhouse for production and self-consumption of vegetables. This building is not connected to the electrical system and to the heating piping system and the water they use comes from a small raft that is filled by gravity by another one with a higher quota.

- There are two other buildings, these constructions are common for the whole village. One of them serves to hold conferences, meetings and other events, who has all the elements of energy as another house, on the roof of this building there are 19 solar photovoltaic panels installed, and a solar thermal panel. The second common building is where most of the energy production is located. There are all the necessary systems to transfer the energy captured by the solar panels, biomass and wind, and to channel, store and distribute it to the different houses, it could be defined as the machine room.

The following can be found in the non-built-area;

- A non-natural raft, created to self-manage the waste water of the houses, and used for irrigation. The energy required for this management is provided by a windmill located on the same raft.
- Lake Bika of considerable size, where different activities such as fishing, leisure, etc. are carried out.
- All of the above things surround a multitude of field extensions, owned by the Foundation GAIA where they manage the biomass used for the production of thermal energy.

## 5.2 Description of the current installation

At present the houses already built and inhabited in the village are supplied with 100% energy from renewable energies. This energy comes from different points;

- Electric energy coming from photovoltaic solar panels located in common buildings [Figure 5]. There are 26 panels of silicon cells available. The photovoltaic cells are associated in series to form solar panels, in the case of the plates already installed have 72 cells per plate and are the plates that give output a mpp voltage (around 36V) and charge 24V batteries. They decided to put these the following way;



Figure 5- Photograph of a portion of installed solar panels

Analyzing the advantages, this type of monocrystalline solar panels have;

- The highest efficiency rates since they are made with high purity silicon. The efficiency in these panels is above 15% and in some brands it exceeds 21%.
- The life of the monocrystalline panels is longer.
- They work better than polycrystalline panels of similar characteristics in low light conditions.
- Although the performance in all panels is reduced with high temperatures, this happens to a lesser extent in polycrystalline than in monocrystalline.

Analyzing the disadvantages, this type of panels;

- They are more expensive. By valuing the economic aspect, it is more advantageous to use polycrystalline or even thin-film panels for domestic use.
  - If the panel is partly covered by shadow, dirt or snow, the whole circuit may be damaged. If you decide to put monocrystalline panels, but you think they may be shaded at some points, it is better to use solar micro inverters instead of chain or central inverters. Micro inverters ensure that the entire solar installation is not affected by only one affected panel.
  - A process called Czochralski is used for the manufacture of monocrystalline silicon. As a result, cylindrical blocks are obtained. Subsequently, four sides are cut out to make the silicon sheets. A lot of silicon is wasted in the process and this does not match the spirit of ecovillage.
- 
- There are 21 solar thermal panels installed, they are the ones that work of simpler form. The rays of the sun heat the panels, which contain a heat transfer liquid that circulates in the interior of the house. These panels, due to their low efficiency and larger size, are only recommended for rural areas, and are also placed together with the photovoltaic solar panels on the roofs of the common buildings of the village.



- There are two types of wind turbines, specifically two tripolar wind turbines [Figure 6] with three-way rotor winding and one vertical axis of smaller size, converting the kinetic energy of the wind into mechanical energy and through a small turbine in electrical energy .



Figure 6 - Photograph of a wind turbine type from the eco-village

The installation of pipes and wiring to the different buildings, both own houses and common buildings, is already carried out. All this installation is underground, avoiding a greater visual impact.

### 5.3 Description buildings construction

This chapter of the study will explain an important part of the work, as it will serve to understand the rest of the study. The GAIA ecovillage, as detailed in point 3, has a different view of the lifestyle of today's society, this is reflected even in the construction of the houses.

The construction of the houses will be made with totally natural materials, these are:

#### - Wood for the structure of the building

As can be seen in the Figure 7 the wood is a main material for the structure of the building.



Figure 7 - Photograph of the wooden structure of a common eco-village building

There are different types of wood as shown in the following image, which gives consistency and safety to the building.



Figure 8 - Photograph of the different sizes of wood used in the structure of buildings

Why was this type of material used? Wood as the main building material has ever been used by mankind, we can say that from its appearance wood was used as the basic material to build houses. There are great advantages to building wooden houses, according to a study from the University of Georgia, these types of houses provide heating and natural cooling due to the density of the trunks. It is concluded that wooden houses based on logs are houses of conservation of natural energy and as such bring great benefits to the people who live in them. Choosing a wooden house will save on heating and cooling, an important aspect that GAIA is looking for.

The trees chosen by people skilled in the construction of these houses are inclined by the use of pine and spruce. The wood of these 2 types of trees is durable and resistant that is why the wooden houses of this tree is stable and long lasting.

All in all, the main features of wooden homes are long lasting. They have a lot of advantages, such as fire resistance, outdoor appeal, high building standards, noise reduction, heating and cooling costs, energy efficiency.

#### - Adobe

The use of adobe [Figure 9] for the walls of the building is another important aspect to detail in this study. This construction technique, like all, has positive and negative aspects. If we talk



about the positives and that are related to the philosophical of the GAIA foundation, it is a material that transpires, presents good aeration. It has a great thermal inertia, so it retains either cold or heat and if we want to take this quality to the maximum we must place the insulation material on the outside and not on the inside of the wall, as usual. Another important benefit is that it has a low cost of realization and little investment in support materials. But the most important of all these aspects is that the construction of the building does not require large foundations or large machinery or great efforts, but it is a fast and simple material to work with, a single person can make the bricks and build

Figure 9 - Blocks of adobe

them with very simple tools, this contributing a point of sustainability and independence to this ecovillage.

As previously mentioned, it also has negative aspects such as the bricks are sensitive to humidity, it is necessary to wait until the bricks dry before putting them in the building, and another important aspect is that it does not serve as a structural wall, when it is used without reinforcements. In the concrete case of this study, adobe bricks are used as walls in conjunction with the wooden structure as shown in Figure 10.



Figure 10 - Photograph of the wall inside the homes

But, how are these types of bricks performed? The technique of the realization is quite simple, first you have to have the main element of the mixture, the soil. The most suitable soil is composed of between 20% and 30% of clay and the rest of sand. The soil is not suitable if it has slime or organic matter (humus).

To check if the soil we are going to use has the right amount of clay and sand we can make a dough by adding some water and making balls with the soil. If they are easily disposed, the soil will probably contain too much sand and we should test hardness with the adobes to see if they are suitable for construction.

An optional material that we can add is the straw that we obtain in the ecovillage. It helps to resist the adobes and prevents them from cracking during drying. The soil is a material that

resists very well to compression but does not work as well to traction, so the straw helps to give this property to the adobe. The mixture should contain 4 parts of soil and 1 part of crushed straw. If the soil is too clayey, 1 part of sand may be added. Mix everything dry and add water to obtain a moldable consistency.

An important aspect in the construction of these bricks is the mold. There are different sizes of adobe bricks [Figure 11]. The most common dimensions in Europe are as follows:



Figure 11 - Block of adobe

The mixture should stand without removing the molds for at least 1 hour. They must be dry to some degree to prevent damage to the bricks when removed from the mold.

Let the adobes dry for about 2-3 days, until the corners start to turn white (indicates they are dry). After this time, we can turn them and sing them to make them dry better. It will take about 1 week to be completely dry. If the bricks crack during drying it means that the soil contains too much clay and we should add sand to the mixture.

During the drying period we can brush the excess of mud and straw in the edges and corners of the adobes.

Once the adobes have completely dried, we must test their resistance. For this we can drop one or two of them to see if they break. We raised the adobe to a height of about a meter and dropped it on the narrow edge. They should stand the fall with little or no damage.

It is always advisable to do a hardness test with 3 or 4 adobe bricks every time we use soil from a different source to check that it is suitable for construction.

If they break, it is probably because the soil contains too much sand and is not useful for construction (the mixture should be stabilized with an additive).

The technical data of adobe bricks depend largely on the type of soil and the proportions we use in the mixture, but approximately are as follows:

- Density: 1500-1700 kg/m<sup>3</sup>
- Compressive resistance: 0.8-2 N / mm<sup>2</sup> (at 28 days of manufacture)
- Good tensile or flexural resistance if they has straw or are stabilized
- Poor resistance to water or ice, it is advisable to stabilize or coat lime
- Resistance to fire: excellent
- Coefficient of thermal conductivity: 0.45-0.8 W / m.K (4 times more insulation than brick)

#### - Wall composition

Another important feature of the walls of the building is its composition when it is built. The wall has a fundamental role, as this will be the one that will allow us not to invest so much money in the heating through the boiler of biomass. The composition of the wall can be seen in Figure 12. First it must be said that the structure is made with wood as discussed above and can be seen in the image.



Figure 12 - Photography of the building wall structure

The wall consists of three main parts. The outer layers, 28 cm each, are made of adobe bricks and in the middle of these two parts, there is a layer of straw and rest of forage, approximately 2 cm thick, which will provide a better thermal and sound insulation, [Figure 13] so that the thickness of the wall will be a total of 60 cm. This means that the wall has a great thickness that will help us to maintain a better heating inside the houses to realize the installation.

The separation wall between the 11 houses has the same composition but changes the thickness, going from 60 cm to 30 cm.

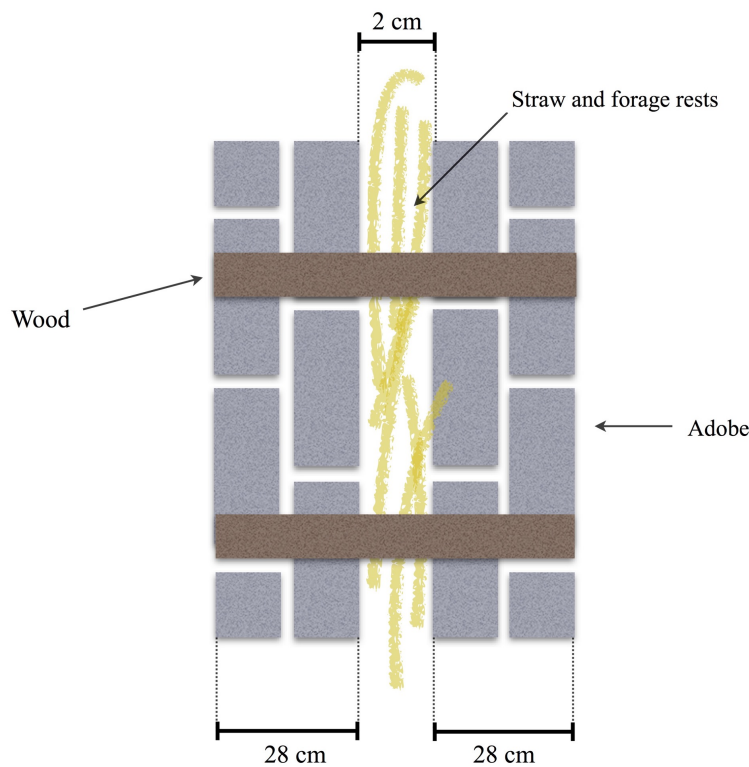

Figure 13 - Building wall structure

## 6. Design alternatives to be considered

Once these problems are observed in Hungarian society, the following alternatives are proposed on the implementation of renewable energies in underdeveloped areas with an ecological vision and trying to reduce waste to the maximum, or achieving zero residues, since rural sustaining can be the key to a growth of the interior communities of Hungary.

Therefore this study will focus on the dimensioning of the heating installation in the largest building of the ecovillage described in detail in section 5.1, this building contains 20 houses, of which only 9 of them are completed, The calculations of the present project will focus on the 11 remaining houses that are not built yet.

This building is designed to be as hermetic as possible, with fairly wide partitions and insulating materials, but heating is essential to deal with the low temperatures in winter in this part of Hungary. However, it is necessary to analyze which type of heating is more convenient, since not all houses need the same system. The choice of one or the other will depend on the location of the house, the climatology and isolation, the size and distribution of the house, the number of inhabitants of the house, etc.

The types of heating can be divided according to the energy source (gas, biomass, geothermal, solar and electric) or according to the apparatus or system from which the heat is obtained (radiant floor, air pump, electric by accumulators, electric by convectors, thermoelectric emitters and boilers with water radiators).

### 6.1 Power source

#### - Gas heating

It is one of the sources of energy most used in homes. For both heating, cooking and hot water production, 3 types of fuel can be chosen: natural gas, C gas oil or propane gas.

Natural gas is a good solution because we do not have to worry about its storage or distribution, however, its supply is usually far from the cities. The second, diesel C, is somewhat more dangerous, since its storage is in tanks inside the houses. It is also more polluting and dirty, although it is a good choice to heat big homes. Propane gas is perfect for large houses or homes in small towns, as it has a heat output higher than natural gas and similar to diesel. It can be stored outside the house, in small containers or in tanks, which makes it less safe than natural gas.



#### -Geothermal

This type of renewable energy is obtained by harnessing the heat from the interior of the Earth. The interior of the Earth is hot and the heat increases as it goes deeper. At great depth we find water tables in which the water due to its great temperature, is heated, ascending in the form of water vapor, until reaching the surface.

#### - Biomass

This source of production is explained in much more detail in section 4.

#### -Solar

Solar energy is a source of renewable energy that is obtained from solar radiation and with which both heat and electricity can be generated. There are several ways to collect and take advantage of the sun's rays to generate energy that give rise to the different types of solar energies: photovoltaic (which transforms rays into electricity through the use of solar panels) and photothermic (which takes advantage of the heat through solar collectors).

## 6.2 System obtaining heat

#### - Electrical heating by accumulation

This is one of the most common heating systems, due to its simple installation, maintenance and safety. Electricity is converted to heat thanks to the electrical resistances inside each electric heater, through which the current flows, converting electricity into heat.

#### - Electric heating by convectors

This type of heating works by a resistance that heats the air that circulates inside the convectors. In this system, perfect for homes located in hot areas, hot water is obtained by the means of a thermos.

Among its advantages are there the following: a cheap installation, without work, and a comfortable supply of hot water. Its disadvantages are: the cost of its operation is usually expensive and the thermos for the hot water consumes enough while it is on, even if it is not used.

#### - Boiler with water radiators

It is the most used system in Spain. The heat is produced, by burning fuels like natural gas, in a boiler located in a specific place and distributed to terminal elements (radiators) by water, emitting heat to those spaces that require it.

The choice of water as a heat carrier is because it is a cheap substance, common in all buildings and its specific heat is greater than of other substances, so it requires a lower volume of water to transport the same amount of heat.

As the boiler is located in another space, it can be freely aerated without problems. This can serve a single user (individual central heating), an entire building (central heating collective), a neighborhood and even a city (district heating).

#### - Thermoelectric emitters

Thermoelectric emitters are oil radiators. This system achieves the transmission of heat through a thermal oil that is heated by a shielded electric resistance of a special steel.

Each radiator is independent and can be plugged anywhere without work, since it has neither boiler nor pipes. To achieve a constant and homogenous temperature, the devices incorporate a thermostat and a programmer, which help to save energy.

Another advantage of this system is that, after turning off the radiators, they continue to radiate heat for hours. They are also safer than water radiators, as the oil does not produce any internal pressure. The disadvantage is that if many radiators are needed, an expensive system is needed and more light power may be required

#### - Radiating floor

Underfloor heating is one of the most comfortable heating systems for cold climates. It consists of an installation of electric cables or pipes through which water circulates at elevated temperature, hidden under the floor of the house. These give off heat, which spreads upwards, heating the floor and the air inside the house.

One of the advantages of this system is that it saves the consumption of heating between 10% and 30%, provides a warm and uniform heat without drying out the environment and allows a more aesthetic image as there are no heating appliances on the walls. It is a safe system, highly recommended if there are children at home. The installation provides additional acoustic and thermal insulation and requires little maintenance.

Among its disadvantages are the high initial investment and the works involved (the pavement of the house must be raised). In addition, saying that until it reaches the desired temperature takes some time, so it is recommended for habitual residences.

#### - Heat pump

The heat pump allows heating in winter and air conditioning in summer in a single device. Providing these two options in a single system, lowers the investment and simplifies the installation. The wide variety of models make it possible to install them in different places.

It is an efficient system, since it consumes less energy until reaching the desired temperature, although the heat is also dispersed before. Therefore, it is recommended in warm or temperate climates with mild winters. Among its disadvantages can be mentioned the noise of the fan, which can be somewhat annoying and the high price of the installation of the heat pump by ducts.

The heat pump requires little care except regular cleaning of the air filter, and too in heat pumps when the temperature is below zero degrees loses the efficiency and increases the consumption exponentially.

### **7. Description of the final solution**

The points to be taken into account when constructing potential energy sources are; waste, integration of food production, construction of technologies based on natural materials and environmentally conscious providing safe living conditions for everybody, since the present project has the main objective to continue with the philosophy of the foundation and the inhabitants of the ecovillage.

For these reasons, the use of the 3 types of fuel gas (natural gas, gasoleo C or propane gas) has been ruled out for the implementation of heating in the building, since it is not governed by the principles that are based on the ecovillage and the inhabitants. They would not accept it, either. The use of some types of boilers with water radiators is also completely ruled out, requiring the burning of some kind of fossil fuel for the creation of heat.

The use of geothermal energy was a very acceptable solution to carry it out. In addition, Hungary has very good geological qualities for this type of energy, but the problem is its high initial cost, which is not acceptable by the foundation.

The use of solar panels to create electricity and use it in a heating system such as electric heating by accumulation, electric heating by convectors, the use of thermoelectric emitters or heat pumps are also ruled out since the ecovillage already has photovoltaic solar panels for creating and using electricity, and this study aims to diversify sources of energy to minimize the risk of running out of energy and to increase the range of possibilities.

The final solution that was chosen and detailed in this study is the use of a biomass boiler for the production of hot water and distribution in the houses by pipes under the ground, this emitter is known as underfloor heating.

The biomass has its inertial character in common with the radiant soil, since none of these components can be stopped instantly, the radiant floor due to the heating of the volume of the mortar above the pipeline and the biomass because once the combustion chamber is heated it is impossible stop burning wood until you are finished with those who have entered the last admission.

The radiant floor is based on radiation, and therefore the transmission of comfort is direct, that is, it does not use air as a transmitting element. And the fact of avoiding the air like "intermediary" implies an energy saving.

## **7.1 Biomass boiler**

A biomass boiler works in a similar way to a gas boiler. The fuel burner burns the wood provided, generating a horizontal flame that enters the boiler, as is often the case in diesel systems. The heat generated during this combustion (in this case of natural fuel) is transmitted to the water circuit in the exchanger built into the boiler. The hot water generated is used for heating. Biomass boilers need storage of the biofuel next to the boiler, in this case the village has a deck next to the machine room where it can be stored. From it, an endless screw or suction feeder takes it to the boiler, where the combustion takes place. When burning biomass some ash is produced, which is automatically collected in an ashtray that must be emptied about four times a year. To optimize the operation of the biomass boiler, we can install an accumulator, which will store the heat in a similar way to a solar energy system.

### **7.1.1 Strengths**

We are talking about a system that offers many advantages, when working with an inexhaustible source of energy, such as biomass. It also produces very low levels of

environmental pollution and helps to reduce dependence on fossil fuels, which are much more polluting, so it is a part of the philosophy of the foundation. The use of these types of boilers will benefit the vegetable matter left over from cleaning the village and the surrounding plots, which will reduce the risk of fire. On the other hand it is a good system to reuse industrial waste. This system uses a high technology, so the devices are perfectly designed and offer the maximum guarantees, like other energies. In addition, plantations of certain species (energy crops) that can be used as biomass in the ecovillage fields can be carried out, which will increase job creation and prevent soil erosion and degradation. It has a much lower cost than conventional energy: it is up to four times cheaper.

### **7.1.1 Weaknesses**

The disadvantages that we can find when installing a boiler system of biomass is that the boiler offers lower yields than of those offered by fossil fuels. The combustible material has a lower energy density which will increase the need for provisioning and the size of the storage spaces. Installation costs are higher. This is relative because the fuel costs are much lower in relation to gas or diesel, the operation is amortized in a short time and will start to be profitable, and reduce costs. Finally we must say that the different types of biomass fuels are at different degrees of humidity so there are times when they require drying treatments. Fuel delivery and ash removal systems are more complex and require higher operating and maintenance costs.

### **7.2 Radiating floor**

This system consists of pipes throughout the surface of the dwelling under the floor that can be parquet, marble, carpet or other materials. These pipes carry hot water, transmitting heat to the environment of the house from the bottom up, it is a very effective system in Hungary, as the houses in this area are characterized with very high ceilings and that makes difficult their fast acclimation.

The maintenance of radiant floor and one of the essential tasks for the maintenance of the radiant floor in our home is the cleaning and recycling of the water that is inside the system. The maintenance work can be:

- Corrective maintenance: when correcting defects, and fixing or changing any of the elements of the system.
- Preventive maintenance of radiant floor: periodic inspections to check the conditions of the system.

We must extract the accumulated substances from the pipes if we do not want them to be sealed, the water cannot flow and it diminishes the heat transmission and the performance of the installation, or it can produce damages in other elements of the installation. Therefore, preventive maintenance is very important, since if the installation is well-maintained we can spend many years without breakdowns and prolong the life of the components.

### 7.2.1 Strengths

This type of issuer has advantages, which are as follows;

- The installation of underfloor heating can save from 10% to 20% compared to other conventional heating systems. This is because the water flow temperature is very low (30-45°) compared to traditional systems (80-85 °).
- We achieve greater comfort since the temperature of the air near the ground will be slightly higher than the temperature of the air at the height of the head. And the heat is evenly spread throughout the house.
- It is a healthier system since air currents do not reduce dust, it does not produce dryness as others do, and the low humidity can prevent the appearance of mites
- This system also allows to use the same installation to cool the floor in summer.
- This system can work continuously many hours so it is very useful for houses or buildings with a busy schedule.
- Another advantage is that it does not occupy space like radiators, and is more aesthetic as it does not affect the decoration of the house.

### 7.2.1 Weaknesses

This type of technology also has a number of drawbacks that will have to pay close attention;

- The installation requires a high initial investment since the price of the floor radiant is greater than that of other systems, but the investment is profitable in the short term.
- Among the disadvantages of radiant floor we find the difficulty of installation, so it is usually used in cases of new work or in an integral rehabilitation, this inconvenience is not present in our case, since it is new construction.
- The time to heat the house when using lower temperatures of water is longer, than with a traditional system.

## 8. Sources of biomass available

The inhabitants of the ecovillage completely extract their own biomass, that is, they produce all the biomass that they consume, they do not need from external suppliers to obtain all the thermal demand that they generate. This biomass that the inhabitants use comes from different sources;

- Residual biomass, within this group there are the biomass;

Agricultural; Within this first group are all the products that come from the remains of the inhabitants' own crops, and pruning rests. In this case, a small portion of grass cut in the non-built area is collected for use as an insulation material in the construction of buildings (explained in more detail in section 5.3) and another for production of thermal energy.

Another portion of biomass within this group are the pruning and maintenance remains that are carried out in the large extensions of field that the foundation has in property. This work is usually done in autumn or late winter every two years and the use of this type of biomass is satisfactory since the calorific value of these remains is medium-high.

Cattle waste; Manure, offal or waste from agricultural and agri-food activities. The usable remains come from the cattle farm in Galgafarm, located 1,5 km far away from the village, but the biogas produced by these manures goes to the production of electricity.

Another small portion of this type of waste comes from the domesticated animals in the ecovillage but in a very small quantity and most of this waste is reused for composting and its subsequent use for the subscriber of the orchards for the production of vegetables in the greenhouse (detailed in point 5.1)

Urban; Biodegradable fractions of waste from individual houses. Although this source would be negligible due to its small quantity and the end use is different from the one of the thermal energy production.

Wood waste; The structure of the houses is made of wood as well as other types of constructions within the plot of the foundation, so it generates a large amount of wood waste, which can be used for the production of thermal energy. This wood is of good quality and has a high calorific value.

To feed the boiler, the types of biomass explained above will be used, but most of the biomass used to ensure a correct operation throughout the year will be from energy crops. The implementation of these crops will be detailed in the following point number 9.

## 9. Energy crops

The biomass that this study will focus on will only highlight lignocellulosic energy crops. These crops that are made for the production of solid biofuels for thermal applications or for the generation of heat and electricity should be as close as possible to a series of characteristics that are set out below. Energy crops, like any other, must take advantage of nature but in no case obviate its laws. Therefore, it is advisable to take into account the following:

- That they adapt to the climatic conditions of the place where they are implanted: the plants give the highest productivities in those places that meet conditions that are more favorable to them.
- High levels of biomass production with low production costs: production that require a lot of cultural attention are complicated and expensive to exploit.
- They are easy to use and require the best known techniques and machinery. What present positive energy balance. This means that more energy is extracted from them than is invested in the crop and its energy plant.
- A high capacity for rooting from esquejes.
- Fast initial growth.
- A great capacity of regrowth and a long duration of the strains.
- That it does not contribute in the degradation of the environment and allow the easy recovery of the land, to implant later other crops in some cases. When possible, rotation is feasible and beneficial at all stages. The great majority of the biomass that will be used in the ecovillage boilers to obtain thermal energy will be through these energy crops, that is to say, plantations are generated with the sole purpose of producing biomass to produce that energy required.

These plantations will be realized in the large extensions of field of property of the foundation GAIA, which reach an extension of 300ha. The type of biomass required by the ecovillage for the boilers is lignocellulosic.



## 9.1 Types of land

In order to fulfill this first characteristic of the above list, it is necessary to know that the influence of the land cannot be totally separated from the climate, since the land-climate ensemble forms an ecological unit. The most suitable soil is deep, with good aeration and drainage. When analyzing the terrain, there are a number of basic parameters (Padilla, 1997) that is necessary to know: the type of the land, active limestone content, organic matter, phosphorus, potassium, pH, land salinity, etc. Among them, the active limestone content and salinity of the soil must be considered, together with the conductivity of the water to be used for irrigation. The combination of these factors together with drought resistance and required vigor will allow us to choose the right species.

The land that presents the area where the energy crops will be introduced will present a land, which due to its strong alluvial or sandy character, has a large amount of water, so it is conducive to this type of crops. The contents of organic matter in these soils are medium-high. They are also favorable in nitrogen and potassium, in this zone it emphasizes the existence of an area of saline-limestone lands, they are lands of fine texture and weak structure. According to an eusoil study. ([Http://eusoils.jrc.ec.europa.eu/Awareness/Documents/EU\\_Presidency/poster1\\_en.pdf](http://eusoils.jrc.ec.europa.eu/Awareness/Documents/EU_Presidency/poster1_en.pdf)) Calcareous brown lands are the most important with a high content of calcium carbonate, ranging from 35% to 63% with a pH close to 8. The organic matter presents values of 1% to 2% and decreasing with depth, the contents of chloride, sodium and gypsum are very low, rising in the lower horizons.

## 9.2 Selected species

*Populus sp* It is a deciduous tree, large, it can reach 20-30 meters in height, are characterized by their extraordinary avidity to water and light, they are generally fast growing, they have great ability for vegetative reproduction and interspecific hybridization [Figure 14].

Poplar cultivation requires loose, well-aerated, deep lands with a low clay content (less than 15%), preferring free or sandy-loam textures, and it is not susceptible to frequent flooding. The pH should be close to neutrality (between 6 and 8),



Figure 14 - photograph of *Populus*

with contents in organic matter higher than 2% and concentrations of active limestone of less than 6%, as well as absence of salinity.

Its adaptability to different lands and climatic conditions has led to their widespread use in developing and developed countries, playing an important role in the rural life of underdeveloped countries with economies in transition. They supply various products (wood, wood logs, firewood, poles and fodder), as well as other services such as protection for soil, crops and livestock, and can give aesthetic value to visitors of the village.

Traditionally they have been integrated in many agricultural systems with temperate or subtropical climate, but recently a new scope has arisen that it can be used use as biomass, as well as its environmental value.

This species is easy to multiply by vegetative means (cuttings and cuttings). These characteristics allow to develop new cultivars facilitating to the workers to multiply with speed and simplicity, and the descendants of certain trees with desirable attributes (fast growth, straight shaft, white wood, etc.). This procedure is called cloning, which allows the establishment of artificial plantations with certain characteristics, it has its drawbacks, if a particular clone is susceptible to attack by a pest or disease, although on the other hand the only problems concerning this type of crops are those causing death or reduced production, and not small-caliber pests that cause aesthetic damage, since only a quantity of wood is needed in the shortest possible time.

*Salix*, Genus composed of some 400 species of deciduous trees and shrubs within the family Salicaceae, are distributed in the cold and temperate areas of the Northern Hemisphere, mainly in humid lands, which presents interesting characteristics for ecovillage, although nowadays it is widely found spread throughout the world (including the southern hemisphere) [Figure 15].

All willows have watery bark, wood is hard, flexible and usually soft. They have slender and fibrous branches and often stoloniferous roots, of which most notable characteristics are their hardness, length and resistance. They also easily



Figure 15 - photograph of *Salix*

develop aerial roots.

As the sexes of the species belonging to this genus are separated, a phenomenon of cross-fertilization occurs, where pollination between individuals is required to generate offspring. This has led to natural crosses between species, generating hybrid organisms (usually a hybrid that arises between two plant species is not fertile, i.e. cannot leave offspring, although there are cases where it is possible and is where they form new species naturally), which improves harvesting after harvesting, although it is easier to reproduce by cuttings.

### **9.3 Operations to be carried out after planting**

#### **9.3.1 Planting time**

The ideal period of planting is once the strong frost is analyzed, that is to say, in the months of February-March and can be extended to March-April by the use of sticks preserved in cold. The stakes are taken to the field in packs of 100 stakes for better handling. The implantation should be done as vertical as possible and with the buds facing upwards. In addition, it is convenient to carry out, after implantation, a first irrigation for a suitable settlement in the soil. Once the soil is wet and the material is settled, it is advisable to have two buds in the aerial part. The planting can be carried out manually by obtaining yields of 1,200-1,300 stakes per day, or planters machines both forestry and agriculture, which greatly increase yield.

#### **9.3.2 Control of weed**

The control of the herbaceous vegetation is a practice that is essential for the correct establishment of the plantation and for its later development until the maturity. It is not only motivated by the decrease in terms of production can lead to this vegetation, as they compete for the use of water and nutrients, but also to the intense competition that is established in the first year by space and light, to be able to drown the development of the young plants and make the crop unviable.

This need for control should be continued immediately after establishing the plantation. The most efficient method is the use of residual herbicides that provide a temporary advantage to the poplar plants, in such a way that they can acquire a size that is clearly competitive against the population of weeds. But the use of these chemicals does not fit the philosophy of the ecovillage, so other methods of control, such as the use of tasks in a mechanized way, may be less effective in that they do not allow the elimination of the herb. Within the zone near the tree, which can force to resort to a manual weeding.

The application of herbicides requires that the buds are closed at the time of application, since there are no selective herbicides available for use in poplars. Although active substances that have been shown to be suitable for use immediately before sprouting in these species are diverse, the registration of plant protection products authorizes a single active substance, oxyfluorfen, with a persistence ranging from 3 to 5 months depending on the type of soil and provided that the film that the herbicide forms on the ground is not altered, either by adverse meteorological factors after application (rain or hail) or mechanical (footprints, tractor passes, etc.). According to VADEMECUM defines Oxyfluorfen, with residual activity and slight effect also by contact, is absorbed by the plant (epiclyate, hypocotyl and leaves), acting on foliar meristematic tissues and controls a wide range of dicotyledonous and monocotyledonous species. The same active material can be presented under different brand names, to be able to vary the support and the additives that accompany it, and therefore to present different commercial names.

Once the planting phase is over, and except for very specific problems, a new application of herbicides will not be necessary, because the high growth rate of the poplar, together with the high density of the crop, produces a high percentage of shading over land. However, if there are problems of persistent invasion that after a correct assessment of the threshold of damage made it advisable to intervene, it is possible to resort to mechanical weeding or applications directed with the active substance glyphosate, authorized for use in forestry operations, always taking into account that it is a total and systemic herbicide, and therefore it is necessary to protect the crop.

The control of weeds through the use of herbicides requires compliance with basic rules that guarantee the effectiveness of the treatment through the proper application of the product (suitable machinery, correct dose, etc.), as well as guaranteeing safety for the applicator (adequate protection ) and respect for the environment (improper disposal, disposal of packaging, etc.).

This technique does not coincide with the philosophy of the ecovillage, so two solutions are proposed.

In recent years, specific machinery has been developed for the mechanical control of weeds in Northern Europe. Weedler is an example of that ([www.salix.se](http://www.salix.se)). However, its characteristics limit it to a specific plantation framework. Carrying out a work with a wheel tractor with discs also allows to eliminate the weeds [Figure 16] , to emphasize the trees in windy zones, and, additionally, to leave buried the dripping pipe if there was one, which can contribute to minimize losses by evaporation of the contributed water.

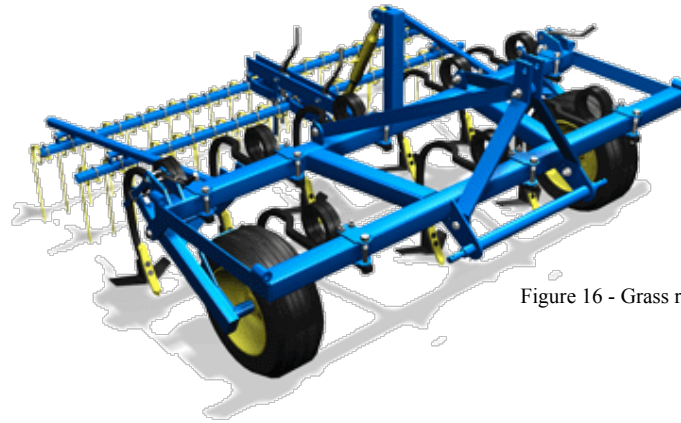

Figure 16 - Grass removal machinery

The other alternative is the use of plastic covers, similar to those used in horticultural crops. This type of roof, regardless of its economic value, is generally suitable for the control of annual species.

### 9.3.3 Replenishment of trees

If planting success is judged to be scarce, between 10% and 15% of trees, which may have happened for various reasons (poor conservation of the crop, poor choice of planting time, unsuitability of the land, death By asphyxiation caused by weeds, etc.) it is not advisable to carry out replenishment in the following vegetative period, a practice that is usually common in plantations with a logging objective. The high planting density would imply a strong competitive disadvantage of the new cuttings in a plantation that already has a vegetative period, which would lead to a new failure. In this case there are two possibilities:

- Assume a major production loss
- Raise and reinstall the plantation. If the percentage of dead trees exceeds 15% it is advisable to re-plant.

When there is no significant loss in the number of plants installed, but rather low growth due to inadequate control of weeds, a cut will be made at the end of the first vegetative period that

offers the possibility of repairing this ineffective control. The growth in this vegetative period will have the advantage of plants that will take a year of root development.

At the same time the cut material, shoots of a year, can be used to make cuttings to be used in a new plantation, which helps to diversify the production of biomass and therefore the income obtained by it.

### 9.3.4 Fertilization

As mentioned in the previous sections, the response of plantations to fertilization depends on a multiple set of factors acting in an interrelated way: land type, initial nutrient content, soil moisture content, seed bank in the land, time and system of application, etc. It is necessary to do a previous analysis both land and foliar before to make a fertilization rationally.

Once the bottom fertilizer has been used to prepare the land, it may be necessary to apply nitrogen on the cover once the crop is already installed, if the content is considered insufficient on the basis of the above analyzes.

In order to reduce the economic and environmental costs, it is necessary to take into account that the contributions provided by the fall of leaves at the end of the vegetative period contribute to the recirculation of nutrients, which reduces the dependence of fertilizers.

According to Domínguez (1997), poplar plants with concentrations in leaves below those that appear in the table, would show nutritional deficiency, which may imply the need to use complex fertilizers.

Element	%
Nitrogen (N)	2,2
Phosphorus (P)	0,17
Potassium (K)	1,3
Calcium (Ca)	0,2
Magnesium (Mg)	0,15

The type of machinery available will determine the fertilizer application system, and can be distributed in the total area, in the crop bands (optimizing the product), or dosed in the irrigation water, allowing a uniform distribution that the irrigation system is drip irrigation.

The solution that will be adapted in this study is the application of irrigation by waste water coming from the homes of the ecovillage, these waters are rich in organic matters, so it is a possibility of reducing fertilization.

### 9.3.5 Irrigation

In general terms the highly productive species and hybrids of the genus *Populus* are characterized by a marked hygrophilia. On the other hand, rainfall maps Segun Hungaria Meteorology Service ([http://www.met.hu/en/idojaras/aktualis\\_idojaras/muhold/](http://www.met.hu/en/idojaras/aktualis_idojaras/muhold/)) precipitations are scarce, and are around of 500 and 600 mm annually. They are concentrated, above all, in the summer, which is the rainiest season. However, thanks to the low temperatures, there are no periods of aridity. It is detailed with more extension in point 2. With a seasonal distribution which is not favorable for poplar, implies important limitations to the development of the crop without the use of regular irrigations during a good part of the vegetative period.

Among the irrigation systems to be used, the application of gravity irrigation (through gutters, etc.), which may initially appear to be more economical, undoubtedly implies inadequate water consumption, while at the same time favoring other unwanted effects such as increased nutrient washing or increased weed proliferation.

Sprinkler irrigation is inadequate in these types of plantations when the plants reach a high size in a short time. Likewise, it can favor the propagation of pests and diseases, by facilitating a high degree of humidity that is also increased by the high density of the plantation.

The solution selected in the present study is drip irrigation (low flow and high frequency), despite its higher initial cost of installation, and the possible discomfort when cutting, presents different advantages. These include saving water consumption by reducing the volume of soil wetted around 35%, which prevents losses by evaporation, less soil nutrient washing, as well as favor the lesser presence of competing weeds. In parallel, this irrigation system allows the application of fertilizer through it, which is commonly known as fertigation. The disadvantage attributed to drip irrigation in Hungary is the possibility of causing tree misalignment when important winds occur, favoring the development of a more superficial root system, since Hungary is characterized as being a windy zone. However, this is not considered important when the poplar is grown in high density and short rotation, and our experience points to a good behavior of the crop under this irrigation system. A possible solution is the use of street cleaning machinery that allows the routing of the rows, could

solve this inconvenience while leaving the dripping pipe buried and facilitates the cutting tasks.

The volumen of the flows to be applied will be very variable and dependent. It is always desirable that the amount of water to be applied is calculated according to the potential evapotranspiration (ETP) and the crop coefficient, thus seeking a greater efficiency in the use of water.

#### 9.4 Control of biotic and abiotic damages

Crop protection encompasses all those fundamentally biological causes that cause loss or decrease in plant production, study how these causes act and how to reduce or avoid these effects (Laborda, 2010)

The presence of plagues or diseases that cause significant losses of foliage during the vegetative period or significant perforations in the wood, can have very negative repercussions in terms of production.

In this class of crops what we want to get from them is biomass, that is why we do not worry too much about insects, fungi, etc, which can produce stains on stems and leaves of the herbaceous plants or on the leaves and trunk of trees. The most important thing to keep in mind, are the plagues that can cause the plant to die, and the most dangerous periods are in the herbaceous plants when the shoots start to emerge after planting and in the trees after the initial planting and later on.

Since in Hungary the number of hectares with this productive purpose is scarce at this moment, as detailed in point 4.2.3, we have to refer to the main phytosanitary problems in Europe for this type of plantations as well as the main plagues or diseases of these crops for wood and which may have importance in this mode of cultivation.

The family of the Salicacea, the species chosen in point 9.2, presents insects that can affect the yield of the growth of these plants or even the death, so much attention must be paid, these are;

- *Populus sp* (Poplar);

*Megaplatypus mutatus*; Fam: Platypodidae. Order: Coleopterous

Insect xylomycephagus that is present in many species of forest interest (polyphitochore), attacks developed plants. They realize internal galleries in the main trunk or thick branches, in the form of spiral and arranged of perpendicular way to the longitudinal axis of the shaft.



Their larvae and adults live inside the trunk, are not fed by wood, but a group of fungi called "Ambrosia" that develop in the galleries. It does not cause the plant to die but its performance decreases. The wind can cause the breakage of the branches.



Gen.y sp. *Stenodontes spinibarbis* N.V. "Large drill"

Fam: Cerambycidae.

Order: Coleóptera.

They attack poplars, willows and other species of forest interest. Adults are large beetles measuring 6 to 6.5 cm. They appear in December and January. The damage is done by larvae that produce large internal galleries, parallel to the longitudinal axis of trunks and branches. It is necessary to maintain the vigor of plants to reduce the probability of attack. Wood for carpentry loses its commercial value.



Gen.y sp. *Megacyllene spinifera* N.V. “Taladro”

Fam: Cerambycidae.

Order: Coleóptera.

Drill that attacks branches and logs. Its main hosts are species of the genus *Prosopis*, although it can be found in other forest species, including *Pópulus* sp. Adults are very active, appearing in late summer and early fall, they are grayish-brown with transverse stripes resembling a yellowish-colored W with dark edges. The larvae measure between 1.8 and 2.5 cm in length. They perform irregular galleries in the trunk, which can become numerous, with a large production of fine sawdust.



Gen.y sp. *Hylesia nigricans* N.V. “Burning bug”

Fam:Hemileucidae.

Order: Lepidóptera.

Defoliate butterfly of Salicáceas and other forest species (polyphithophaga). Causes shrinkage in the potential yield of the tree. In control can be realized by chemical products, like the pyrethroids and by *Bacillus thuringiensis* that is efficient in the fourth and fifth stage of the larva.



Gen.y sp. *Automeris viridescens* N.V. “Big burner bug”

Fam: Hemileucidae.

Order: Lepidóptera.

Insect defoliator lepidoptera of Salicaceae and other forest species. The larvae are large, with stinging hairs, emerge in spring and buzz in the trunk. They have a wintering cocoon.



Gen.y sp. *Oiketicus platensis*

Fam: Psychidae.

Order: Lepidóptera.

Lepidoptera of crepuscular or nocturnal habits whose larva feeds on leaves of a large number of broadleaf (polyphitochore) forest species, the poplar, willow, ash, white acacia, maple, including ornamental shrubs are very attacked. Chemical and biological controls are needed.



Gen.y sp. Pemphigus populitransversus N.V.

Fam: Eriosomatidae.

Order: Hemiptera1

Greenfly that causes the formation of subglobular galls with a transverse orifice and located in the petiole of the leaves of Pópulus sp. When the galls, which is the colony of this insect, break, release individuals who are dispersed on the plant. The damage is caused by the sucking sap. They produce defoliation.



Gen.y sp. Melodoigyne incógnita

Fam:Heteroderidae.

Type: Remata.

Nematode can be found on the ground. Causes decay of the branches, and can cause the death of the plants. The species susceptible to its attack are willow-poplar, poplar and hybrid willow. It is recommended to cultivate the susceptible species in low and flooded lands, where the nematode does not progress.



- In *Salix sp* (Willow):

Gen.y sp. *Nematus oligospilus* (desantissi) N.V. “Wasp of willow”

Fam: Tenthredinidae.

Order: Hymenóptera.

It attacks willows, producing severe defoliations. Winter spends like wintering larvae on the ground. The adult female emerges in early spring, apparently in coincidence with the foliation of the willows. Biological and chemical controls are needed. Monitoring with yellow glue traps is recommended.



Gen.y sp. *Tuberolachus salignus* N.V. “Giant Willow Agar”

Fam: Aphididae

Order: Hemiptera1

Large greenfly, reaching 5 mm, gray ash color, with presence of a dorsal root tuber conical in the abdomen (differential character). It is observed periodically on branches of 1 or 2 years of willow. They also are in cutting and in wicker plantations.



## 10. Process of obtaining the biomass

### 10.1 Pruning

Taking into account the part of the biomass that is used in the ecovillage comes from the remains of maintenance as pruning of ornamental plants distributed throughout the perimeter of the built area.

These maintenance processes contribute a type of vegetal material with little calorific power, although it is used both for the generation of thermal energy and insulating material in the new buildings.

The pruning of more interest for the objective of the project, is the pruning that is realized in the spring and at the end of the summer, where the maintenance tasks are bigger.

There is another amount of plant material, this group is considered to all products and remains that come from maintenance work and improvement of the fields surrounding the village. As it is in an enclave with little forest mass, the percentage of this group is not very relevant.

But the biggest amount of biomass comes from energy crops, and pruning is very important. Cutting or harvesting operations must be carried out in a mechanized manner, since a manual cut is economically unfeasible.

The cuttings are done after reaching maturity, which will be a function of the initial density of planting and plant material used. They are carried out during the period of vegetative stop, that is to say, after the fall of the leaves and before the new buds begin to sprout, they must be carried out in a moment in which the ground is able to support the passage of the machinery without excessive compaction of the field.

It is important to ensure the future viability of the stump, making the cut to a height that in no case should exceed 10 cm above the ground, and even recommended lower cutting heights, in order to ensure that with successive crop cycles the stump does not hamper successive cutting tasks [Figure 17].

The number of cutting cycles that are able to support the plantation is strongly influenced by the site characteristics, plant materials and applied management, without the definition of fixed rules. However, it is generally considered that the number of crop cycles can range from two to six.



Figure 17 - Photograph of a correct cut of *Populus*

Once the number of optimal production cycles of the vines has been exhausted, the plot must be cleaned, destroying the root systems as well as the stumps using the available machinery.

## 10.2 Harvest

Harvesting is the most technically complex operation to perform in this type of crop.

The cut is made in winter, usually between November and February, after the leaves fall. In this operation it is very important to take into account the practicability of the land due to its texture and moisture content, factors that combined, can hinder and even prevent the harvesting operation. If the machine is very heavy, it can compact the land and affect its structure.

In addition, the collection methods to be used also depend on parameters such as the area of harvesting, development and design of the plantation and other indirectly influences such as access to crop plots, availability of biomass storage area, etc.

The wide variety of local circumstances and the very limited experience so far in this operation means that there is no general criterion on how to make the usage. However, two main systems can be distinguished: cutting and splintering in the same operation, or, only short, producing rods in the form of loose beams or rods.

The choice for ecovillage will be only short, since the type of boiler to be used supports this type of wood, in addition as the majority of this wood is to be stored this technique is more interesting due to better conservation of the biomass in these conditions.

### **10.3 Transportation**

The transport of biomass to the plants of conditioning and recovery is a key factor, directly influences the viability of a project of efficient energy use of this type of fuel.

Cultivation plots should not be used for biomass storage in the field, because of the danger of damaging the wheels of the vehicles during these activities, as well as causing damages to the stumps of the plants with the consequent decrease of production in successive years.

So the solution chosen in the ecovillage, is to carry out the plantations near the place of provision, this is possible since the fields owned by the foundation surround the village, to have a more comfortable, simple and more economic transportation.

### **10.4 Process in the plant**

The only process to be carried out to the biomass is the transport explained in the previous point, and the storage and its natural drying, which will be explained in more details in point 10.6.

### **10.5 Biomass Storage**

One of the main advantages of the biomass is its storage, since it can adapt its shape to the different possible storages, its durability is high and the maintenance of the storage is almost nothing. On the contrary, it has a great disadvantage that its storage needs a large space but this is not a big problem for the ecovillage, since as previously stated, the Foundation has large plots and a common building already built that serve to protect the wood stored.

The energy crops present seasonal production patterns, i.e. the harvest dates are for a fixed period, while the consumption of a thermal plant is carried out throughout the year (constant demand), due to this main reason will be necessary to store the production. Storage is relevant, especially when it is for a long period of time, as it will affect costs, quality (calorific value, moisture, molds, ash) or loss of dry matter among others.

The advantage that the ecovillage has, is important, since having a roof already built, and it reduces the investment. The storage of the biomass of the logs from the energetic crops will be carried out here.



## 10.6 Biomass drying

Usually, the biomass presents a high degree of humidity, except in the case of some biomass of industrial origin that have been previously dried in its processing (wood residues, dried husks, etc.). The drier the fuel, the lower the energy. It is required to evaporate the remaining water and, therefore, the greater energy will be available to generate heat.

The amount of moisture contained in a biomass is a very important factor in the combustion efficiency, since the equipment is designed to operate optimally with a fuel that moves in a strip of humidity. When these levels are exceeded, both above and below the design values, there are usually problems of operation and emissions.

The size of the biomass particles is defined by the type of combustion technology used. In addition, it has an important effect on the absorption of moisture, as it increases as its size decreases. The microbial action on the biomass increases when the particles decrease, increasing the possibility of producing undesirable effects on the fuel as is the auto-combustion by the anaerobic fermentation.

Therefore, it is advisable, in the case of long-term storage, not to dispose the biomass in excessively small sizes, reserving the reduction of the biomass prior to its use as fuel. Much of the waste biomass is not directly usable for certain uses for energy purposes, if its moisture content is not previously reduced.

However, the costs of drying use a conventional fuel may in some cases be prohibitive, so that wherever possible moisture reduction methods should be used at the lowest possible cost.

FAO defines the natural drying of biomass as a simple technique based on the use of favorable environmental conditions to facilitate the dehydration of the residues and to obtain humidity levels that allow an economic management and that facilitate the following transformation phases to be carried out, or to obtain acceptable yields in the energy conversion processes to which the waste is destined.

Processes as simple as the turning of the biomass can achieve great reductions of humidity of economic form. In any case, natural drying is a dynamic process, so it must be controlled at all times to obtain a final product suitable for energy recovery. To carry out an adequate storage the following points must be followed;

- Avoid as far as possible the deterioration of quality, as is the increase of Humidity and contamination with dust or dirt.

- It will keep the place as dry as possible, with protections of the possible rains or snowfall
- Ground free of obstacles. Floor in plant and terminal covered with bituminous surface. Non-clay soil and level ground.
- The store must be higher than the rainwater circulation ways.
- To prevent a pile of bales from absorbing soil moisture, place a dry base underneath (pallets, old bales, old trunks). To avoid being moistened by the top cover the pile with a protector (agricultural film, old bales, marquee).
- Storage to minimize self-heating:
  - o Avoid growth of microbes (Humidity <20%).
  - o Avoid mixtures of different qualities if they are later to be stored.
  - o Preferred small piles and short time.
  - o Avoid compacting material.
  - o Stacks of elongated clusters with wide base, double height

## 11. Impact of the project for the rural development

Nowadays there is no discussion about the role that biomass can play as a renewable source of energy, capable not only of contributing to achieve energy efficiency targets or reducing emissions of polluting gases into the atmosphere, but also of generating a series of added benefits, such as job creation in rural areas, aid to the conservation of forests, reducing the risk of fire, among many other things.

The technological improvement and the guarantee of supply, from the point of view of the consumer, have been two key elements in the maturing of a still incipient market in many regions, not only of Hungary, but throughout Europe.

The implementation of energy biomass markets generates a series of economic, social and environmental benefits that have been described in numerous publications and are collected by government strategies and plans.

To explain in more details, this series of benefits have been classified into two groups, benefits for the environment and another group referred to social and rural benefits.

## 11.1 Environmental impact

As detailed in point 4.2, biomass is the most widely used renewable resource in the world and one of the renewable energy sources with the greatest potential for growth over the coming decades. This growth is only due to its countless positive environmental points.

The present project studies the viability of installing biomass heating to homes located in rural settings disconnected from the electricity grid. Normally these types of renewable energy production systems are given a clear benefit, the reduction of the pollutant load caused by fossil fuels. Biomass energy does not contribute to climate change since its CO<sub>2</sub> emissions balance is neutral. This zero balance means that burning the biomass to obtain energy releases CO<sub>2</sub> into the atmosphere, but during the growth of organic plant matter CO<sub>2</sub> is absorbed. In this way the cycle closes and the level of CO<sub>2</sub> emission in the atmosphere remains constant, but in the case of biomass there are other environmental benefits, such as the following:

For example an important aspect that grants the use of biomass as an energy source is to provide the appropriate waste treatment, which in some cases are contaminating pollutants. These are municipal waste, waste water and slurry, which are dangerous to the environmental health as they can reach groundwater underground.

Another aspect to consider is that it generates lower emissions than conventional fuel boilers, reduced sulfur and particulate emissions and reduced emissions of pollutants such as CO, HC and NO<sub>x</sub>.

On the other hand, depending on the origin of this biomass, it can also provide other environmental benefits, such as when GAIA ecovillage manages waste from pruning and cleaning of the surrounding tree areas, thus limiting the spread of fires. Thanks to this use of the residues of these techniques of maintenance a healthy and clean landscape is observed, that not only provides better aeration for the plants and its better development maintaining the controlled population of pests, but also helps to maintain an ecological balance. Biodiversity is also enhanced by the use of these cleaning tasks.

The use of residual forest as fuel for biomass boilers is one of the solutions to facilitate the improvement of forests. In the latter case, stubble and agricultural pruning could be included, whose traditional burning in the field entails, as has been said before, an added risk of fires. This biomass can find a new market in the production of energy even for the foundation itself, since the 300ha that they have in property may be a favor in order to obtain a large amount of biomass to later obtain economic benefits.

Lastly, it should also be noted that the introduction of energy crops also has environmental benefits, for example the use of abandoned land prevents soil erosion and degradation, which can be a serious problem in certain rural areas of Northern Hungary by the terrain orography, explained in more details in section 4.2.3 of the part of the work memory.

## 11.2 Social and rural impact

The other large group of these benefits that the usage of biomass as renewable energy for heating in rural dwellings brings is the social benefits and what can contribute to these rural areas.

First of all it should be said that the work is focused on the study of the implantation of renewable energy in a village where people are already aware that this alternative is the best solution. As mentioned in point 3 of the part of the report of the work, the ecovillage belongs to GAIA foundation, which works for the expansion of its philosophy of life, this means that ecovillage is not only a place to live but receives visitors to carry out different activities, from children from schools to trips of old people to learn about how these types of villages work. This means that the use of biomass in the ecovillage not only implies the environmental benefits described above but also a component of expansion of ideas, where visitors can observe, learn and share that this type of renewable energy can serve to expand beyond of the ecovillage. So with a correct use of this energy in the homes of this place can serve as a loudspeaker to expand the use of biomass in other similar places.

In addition biomass produces a strong positive impact on the territory, with added social benefits, these are the following:

On the one hand, it is important to say that the use of biomass as renewable energy in these rural areas, with a population shortage, is a good alternative since it can set people in rural areas and becomes an economic source in those places.

The creation of jobs is a very important aspect to take into account since only in the work of collection, treatment and distribution of fuel can generate different specialized jobs, as in the maintenance of boilers. The number of employees that could be generated would not be excessively high, but in the territory has a great impact, since these are stable jobs and that would help to fix the rural population, with associated benefits that this entails.

These jobs would generate other indirect ones, related to the own chain of distribution and consumption of biomass, plus those that derive from the generation of a more robust and vertebrate local economy.

It would open the possibility of diversifying rural economies, allowing different ways of implementation, from local consumption to international exports, as Hungary is a good place to produce energy crops

## 12. Conclusions

In the first part of the study the concept of biomass was analyzed in depth, including a compilation of data on the types that exist, the forms of conversion in energy, their characteristics, and a study has also been carried out to obtain the possibilities and the biomass situation within the ecovillage, giving alternatives to possible problems.

Obtaining the conclusion that the use of biomass has a very basic but fundamental advantage, to convert a waste into a resource, i.e. with a correct treatment of biomass involves an increase of recycling and a decrease of waste, with hat this project would perfectly fit within the philosophy of the foundation GAIA.

This project is returning to the beginnings of human existence, to use all the possible resources that nature will provide us for the construction of houses that provide all the needs that today are demanded.

This project can serve to teach and publicize this type of construction, since the eco-village is a tourist place, and increases the demand of the biomass boilers in the nearby populations and look for synergies to obtain biomass, with possible ways of development and new business.

### 13. References

[1] Observatoire des energies renouvelables (Eruobserv'Er), <https://www.eurobserv-er.org>

[2] European Data Agency, <http://www.datosmacro.com/paises/hungria>

[3] Plant health european union, [http://ec.europa.eu/food/plant\\_en](http://ec.europa.eu/food/plant_en)

[4] European Statistics (Eurostat), <http://ec.europa.eu/eurostat/>

[5] Weather conditions hungary, [www.met.hu/](http://www.met.hu/)

[6] International Energy Agency (IEA), <https://www.iea.org>

[7] MODULE 3: BIOMASS , CHAPTER 4. Fully developed case study of application of biomass to rural development: The Biomass Power Plant and the floodplain restoration of Tiszatarján, Subchapter 4.2.: Technical and economic aspects of the case study.

[8] MODULE 3: BIOMASS, CHAPTER 3. Social and environmental aspects for rural development. Subchapter 3.1.: Assessment of environmental impact. Emissions and Life Cycle Analysis.

[9] MODULE 3: BIOMASS, CHAPTER 2. Economic aspects. Subchapter 2.3.: Analysis of economic efficiency and profitability.

[10] MODULE 1: RENEWABLE ENERGY AND LOCAL DEVELOPMENT, CHAPTER 4. Development in rural areas, Subchapter 4.3. Social sustainability and development. Living and working in rural areas



**Compilation of case studies of applying renewable energies to local  
development nationally & transnationally implemented**



Co-funded by the  
Erasmus+ Programme  
of the European Union





# Calculations and design





**Compilation of case studies of applying renewable energies to local  
development nationally & transnationally implemented**



Co-funded by the  
Erasmus+ Programme  
of the European Union



## 1. Introduction

This section of the paper will describe the process according to the size of the facilities of the building of GAIA ecovillage.

As for the air conditioning of the different houses of the building, the computer program DPCLIMA of the Polytechnic University of Valencia was used, which allows to estimate the thermal loads of the different rooms. This computer program requires the introduction of indoor conditions, exteriors, composition of building enclosures, among others and with these data gives the total thermal loads. It was the basis for choosing the power of indoor and outdoor units needed in each location.

## 2. External climatic conditions of calculation

The first step to calculate the thermal loads and energy required of the eco-village, we must know the climatic conditions to which it is subjected. The choice of the external conditions of dry temperature, and, where appropriate, the simultaneous humid temperature of the place, which are necessary for the calculation of the maximum instantaneous thermal demand, i.e. for the dimensioning of necessary equipment and apparatus, will be made on a basis of the criteria of percentile levels, which may be even different for different dwellings of the same facility of the building.

For the calculation of the energy consumption of the building during a year it's necessary the data of the typical year of the location of the building(dry temperature, coincident humid temperature and solar radiation)

### 2.1 Latitude, longitude and altitude

The following table shows the latitude, longitude and altitude of Galgahévíz, the village closest to the ecovillage, which is about 3 kilometers far away.

	Latitude	Longitude	Altitude
Budapest	47,43	19,18	131
Galgahévíz	47,37	19,33	151

## 2.2 Dry temperature and humidity

For the dimensioning of energy transfer devices with the external environment, the percentiles of 0.4% in summer and 99% in winter when the weather is dry or wet, as the case may be, shall be considered.

The use of this criterion carries the risk of oversizing the installation, or a part of it, by default, for a certain number of hours per year. This risk must be evaluated according to the use of the building (reliability) and told to the user.

## 2.3 Percentile level

For the calculation of the maximum thermal loads in winter, the temperatures of the dry air to be considered will correspond to the following levels:

1. 99% level for hospitals, clinics, nursing homes, centers of calculation and any other space that the design technician considers to be necessary to have this degree of coverage.
2. Level of 97.5% for all types of buildings and spaces not mentioned above.

It is also reflected, that, as extreme summer project conditions, those based on the percentiles of temperatures of dry and wet air in the total hours of June, July, August and September (122 days → 2928 hours ).

1. 1% level for hospitals, clinics, computer rooms and any other space that the design technician considers necessary to have this degree of coverage.
2. 2.5% level for buildings and spaces that are of special consideration. As a result, the percentile levels shown in the table below will be adopted:

Type of Building	Percentile level	
	Summer	Winter
No maxima coverage	1 %	-97,5 %

## 2.4 Temperatures and humidity

The outside temperatures and humidity used for the dimensioning of the installation are shown in the following table;

Land temperature (°C)	5
Max. Outside temperature (°C)	33,5
Relative humidity (%)	30,34
Minimum outdoor temperature (°C)	-7
Relative humidity heating (%)	85,8

## 2.5 Temperature oscillations

The maximum oscillations for both winter and summer are as follows:

	ADO	AAO
Summer	18,1	38,8
Winter	0,5	

Where,

ADO Is the Average Daily Oscillation and is expressed in degrees

AAO Is the Annual Average Oscillation and is expressed in degrees

## 2.6 Radiation data

An important fact of Hungary is that it is rather plain country, 98% of the area less than 200 m, which causes a very flat area to receive solar radiation. According to a study by Országos Meteorológiai Szolgálat shows different zones according to the annual average global solar

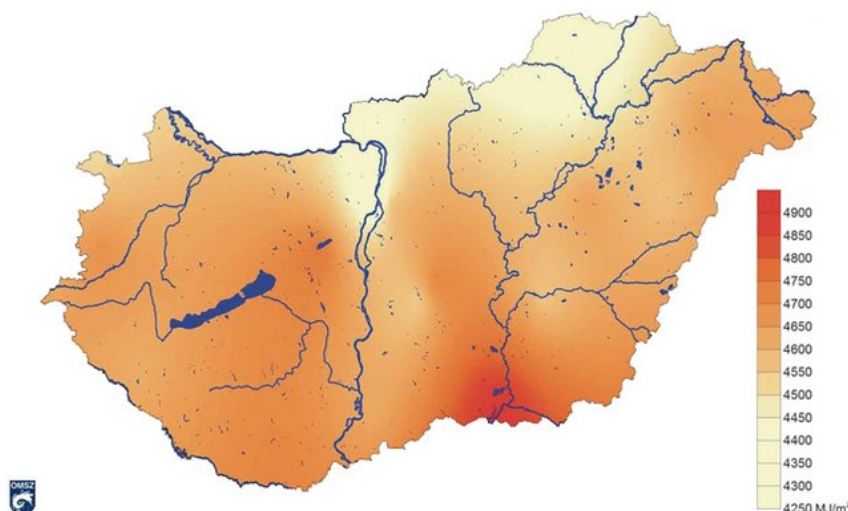

Figure 18 - The average annual global radiation (MJ/m<sup>2</sup>) in Hungary (2000–2009)

radiation on a horizontal surface in Hungary. By global radiation we mean the sum of the direct radiation of the Sun and the diffuse radiation coming from the sky [Figure 18].

## 2.7 Intensity and direction of prevailing winds

In order to obtain this information the Meteoblue data base has been consulted, where data are displayed since 2003 [Figure 19], and in particular in this rose of the winds for Hungary shows the number of hours a year the wind blows and the position of the radial bars shows the direction from where the wind blows and those are the data used in the VPCLIMA program to dimension the installation.

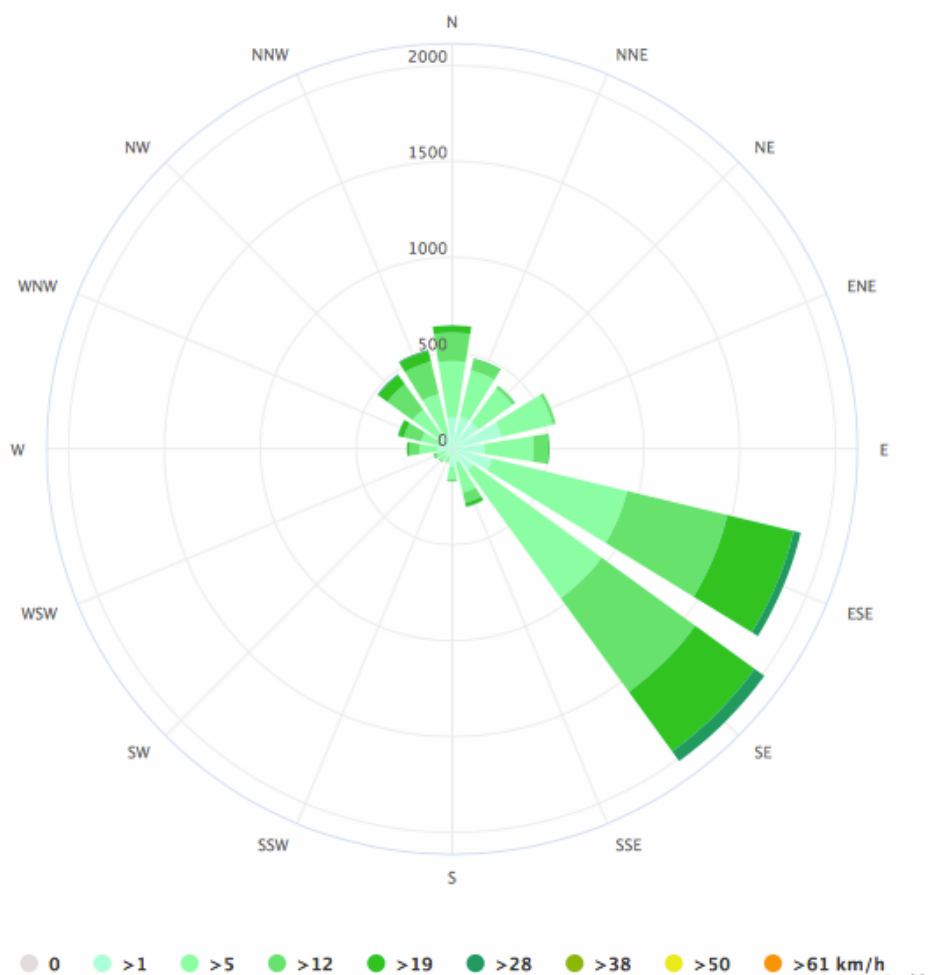

Figure 19 - Intensity and direction of prevailing winds in Hungary (2003–2013)

### 3. Internal conditions of calculation

For dimensioning the entire installation, data are also needed on the interior conditions of the dwellings, whether they are all the same or if there is any difference between them.

#### 3.1 Temperature

The design of the thermal installations must be based on a set of premises, knowledge of internal conditions to be fulfilled, the external conditions, as well as the criteria and precepts that allow to estimate and achieve their adequate behavior with respect to the welfare functionality, security and rational use of energy. Thus, thermal well-being means those characteristics that condition the human body's thermal exchanges with the environment, depending on the person's activity and the thermal insulation of his clothing, and which affect the feeling of well-being of the occupants.

This project seeks an air temperature inside the heated homes, which will not exceed 21C°, when it requires energy consumption for the generation of heat by the heating system. The temperature of the air in the refrigerated rooms will not be less than 26C° and as regards the above temperature conditions will be concerned with maintaining a relative humidity between 30% and 70%.

#### 3.2 Humidity

The above temperature conditions will be related to the maintenance of a relative humidity between 30% and 70%.

Therefore, in compliance with the above requirements, the following values of relative humidity will be taken in the project:

Season	Relative humidity (%)
Summer	50 %
Winter	40 %

### 3.3 Noise and vibration

The noise generated by the components of the thermal installations can affect the well-being and comfort of the occupants of the premises of the building, as well as the vibrations to the adjustment of the machines, the sealing of the ducts and the structure of the building.

In this sense, the design of the installation should take into account those techniques or systems that guarantee the attenuation of noise and vibrations to the values specified below.

To maintain vibration levels below an acceptable level, equipment and lines must be insulated from the structural elements of the building.

## 4. Coefficients of heat transfer of the building elements

The purpose of this section is to determine the different elements that make up the building, classify and analyze them in order to dimension the installation of the heating.

### 4.1 Composition of the constructive elements

In the whole building we find the following elements that condition the losses of the installation;

- Doors and windows
- Enclosure exterior walls of building
- Ground of building in contact with the land
- Wall between floors
- Interior partition

#### Doors and windows

This section summarizes the characteristics of the windows that are included in this project:

Materials	Thickness (m)	R (W/m <sup>2</sup> °C) <sup>-1</sup>
Crystal	0,006	
Air chamber	0,008	
Crystal	0,006	
		2,5

The transmission of the gap is  $2,5 \text{ W/m}^2 \text{ }^\circ\text{C}$ , with a percentage of the frame of 10% and a solar factor of the gap of 0.45. In the ecovillage there are different types of windows that only differentiate between them by size, the largest have a surface of  $2,1\text{m}^2$ , and the smallest  $0,36\text{m}^2$ , and are combined in different homes.

### Enclosure exterior walls of building

The facade of the building is made up of three different materials, with the peculiarity that all of them are governed by the ecological philosophy without neglecting efficiency, these characteristics are summarized in the following table:

Materials	Thickness (m)	R ( $\text{W/m}^2 \text{ }^\circ\text{C}$ ) <sup>-1</sup>
Adobe	0,56	0,246
Straw and forage rests	0,20	0,250
Wood of medium weight	0,20	0,110

The total result is  $U=0,71 \text{ W/m}^2 \text{ }^\circ\text{C}$  and a total weight of  $464,10 \text{ Kg/m}^2$ .

### Ground of building in contact with the land

This section describes the composition of the ground floor that consists of different types of wood forming a structure, which is just above the ground on which the building is built, this terrain is flat and has grass:

Materials	Thickness (m)	R ( $\text{W/m}^2 \text{ }^\circ\text{C}$ ) <sup>-1</sup>
Very light leafy wood	0,20	0,154
Wood of medium weight	0,20	0,110
Very heavy leafy wood	0,35	0,069

The total result is  $U=1,98 \text{ W/m}^2 \text{ }^\circ\text{C}$  and a total weight of  $37,6 \text{ Kg/m}^2$ .



### Wall between floors

This section summarizes the characteristics of the interior wall that divides between the two floors and between the dwelling, the loft and in turn serves as ground of the upper floor, and influences considerably in this project:

Materials	Thickness (m)	R (W/m <sup>2</sup> °C) <sup>-1</sup>
Wood of medium weight	0,2	0,110
Straw and forage rests	0,2	0,250
Very heavy leafy wood	0,2	0,087

The total result is  $U=1,62 \text{ W/m}^2 \text{ °C}$  and a total weight of  $56 \text{ Kg/m}^2$ .

### Interior partition

The composition of this type of enclosures is as follows:

Materiales	Thickness (m)	R (W/m <sup>2</sup> °C) <sup>-1</sup>
Adobe	0,280	0,246
Very heavy leafy wood	0,230	0,087
Straw and forage rests	0,200	0,250

The total result is  $U=0,92 \text{ W/m}^2 \text{ °C}$  and a total weight of  $261,2 \text{ Kg/m}^2$ .

## 5. Calculation of thermal charge

In this section, all the final loads of the village and the energy consumption of the heating, will be calculated all together, and separately for each dwelling, too. The following calculations were performed with the VpClima software, based on all the data collected in the field study and detailed in points above 2, 3 and 4.

The following is a simplified summary of the calculations made in this software.

### 5.1 Building description

The building where to be installed the installation, as explained above, has 11 houses where will be install the heating, of which 2 of the second floor are connected with two of the first floor, so even though are considered different local, are of the same property. Of four locals they form two houses of two plants.

The building in total has these characteristics;

Building description	Results
Conditioned area	475 m <sup>2</sup>
Volume of the air conditioning	1321 m <sup>3</sup>
No conditioned area	0

The building is divided into 11 locals, which are not the same, have different dimensions, they are described in the following table;

Number of house	Area (m <sup>2</sup> )	Volume (m <sup>3</sup> )	Number of people
House 1	43,46	129,08	2
House 2	39,98	111,14	2
House 3	38,97	108,34	2
House 4	35,40	98,41	1
House 5	36,32	100,97	1
House 6	38,77	107,78	2
House 7	58,74	163,30	2
House 8	32,18	89,46	1
House 9	40,68	113,09	2
House 10	53,82	149,62	2
House 11	53,82	149,62	2

The composition of these houses is as follows;

- Residential housing, with a maximum space of 25m<sup>2</sup> / peop. and with a very light work activity.
- A sensitive power of 86W/peop.
- Types of led lights, which transmit 7 W/m<sup>2</sup> and other power sensitive by another type of electronic equipment of 5 W/m<sup>2</sup>

### 5.2 Calculation of thermal loads of the village

The software determines maximum demand for heating of a day, in the specific case of this study it is in February at 6 in the morning. This chapter will detail the results of that day.

In the following table are represented the results of the thermal loads of the sum of the 11 houses of the building.

Building	Results
Area (m <sup>2</sup> )	475,11
Total Loads (kW)	53,85
Ratio (W/ m <sup>2</sup> )	113,33
Ventilation (kW)	5,40
Enclosure walls(kW)	39,49
Spaces (kW)	6,40
Enlargement factor (kW)	2,56

The following graph shows the same previous results but shows the variation of demand during the different hours of that day of peak demand in February:

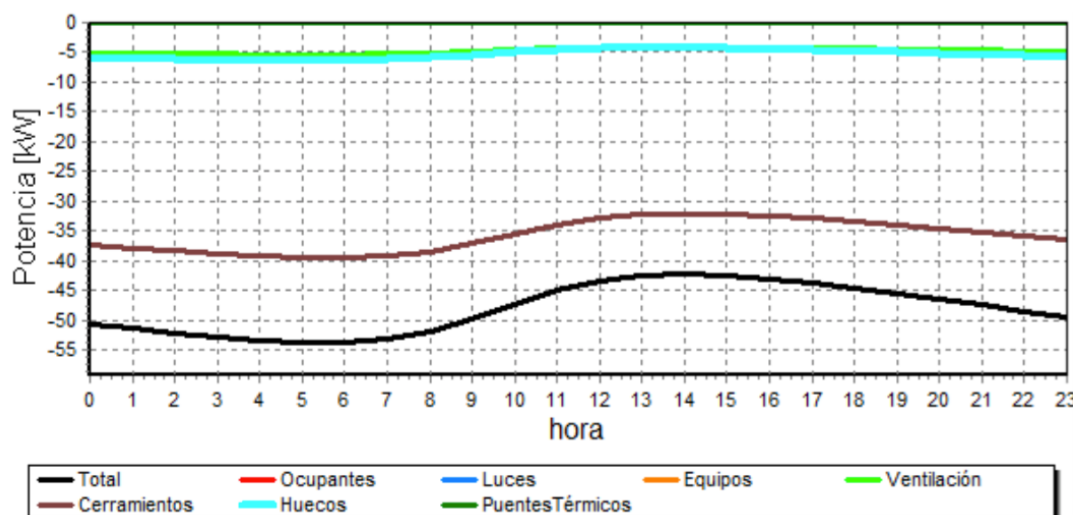

The black line represents the sum of the different colored lines, expressed in kW along the day of maximum demand of the year.

The individual results of each house will be shown below:

**- House 1**

House 1	Results
Area (m <sup>2</sup> )	46,43
Volume (m <sup>3</sup> )	129,08
Total Loads (kW)	5,68
Ratio (W/ m <sup>2</sup> )	122,39
Ventilation (kW)	0,53
Enclosure walls(kW)	4,33
Spaces (kW)	0,55
Enlargement factor (kW)	0,27

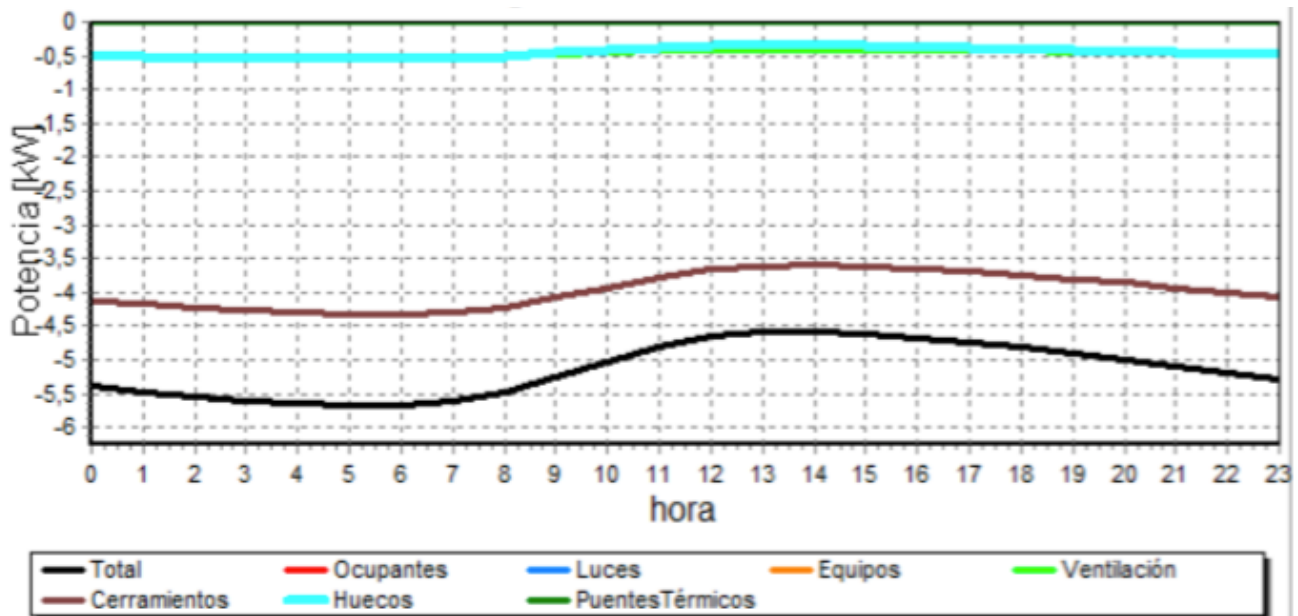

- House 2

House 2	Results
Area (m <sup>2</sup> )	39,98
Volume (m <sup>3</sup> )	111,14
Total Loads (kW)	5,20
Ratio (W/ m <sup>2</sup> )	129,95
Ventilation (kW)	0,45
Enclosure walls(kW)	3,92
Spaces (kW)	0,52
Enlargement factor (kW)	0,25

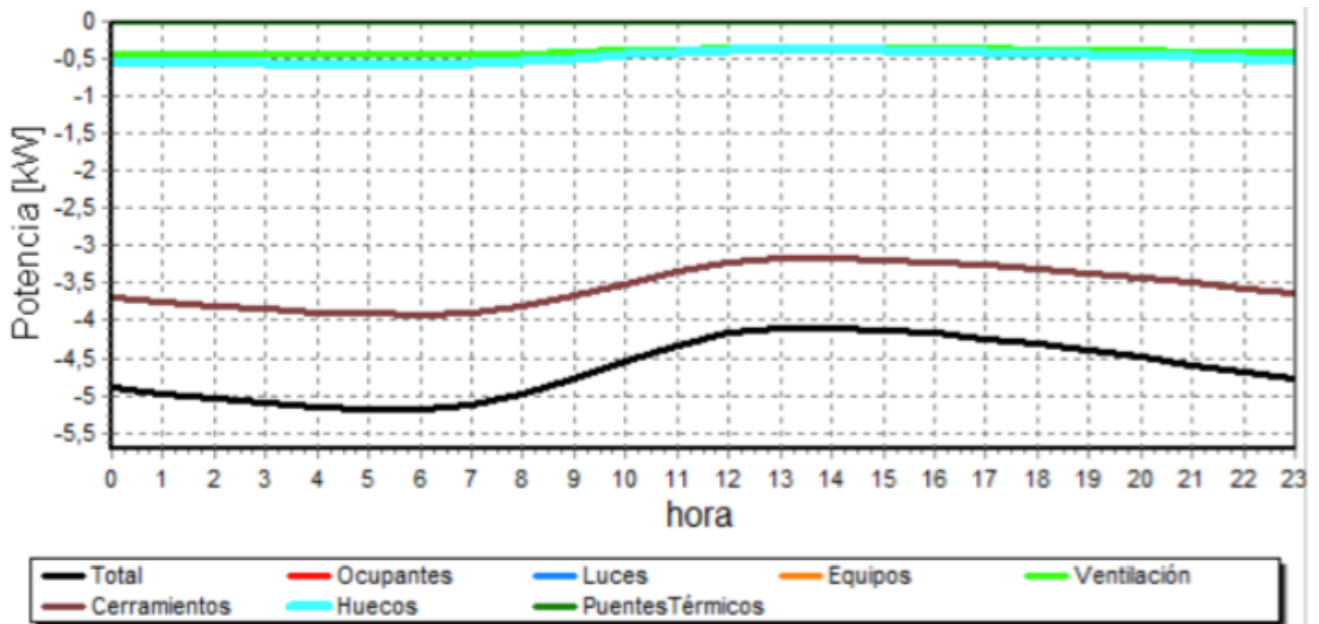

- House 3

House 3	Results
Area (m <sup>2</sup> )	38,97
Volume (m <sup>3</sup> )	108,34
Total Loads (kW)	2,82
Ratio (W/ m <sup>2</sup> )	72,47
Ventilation (kW)	0,44
Enclosure walls(kW)	1,58
Spaces (kW)	0,13
Enlargement factor (kW)	0,27

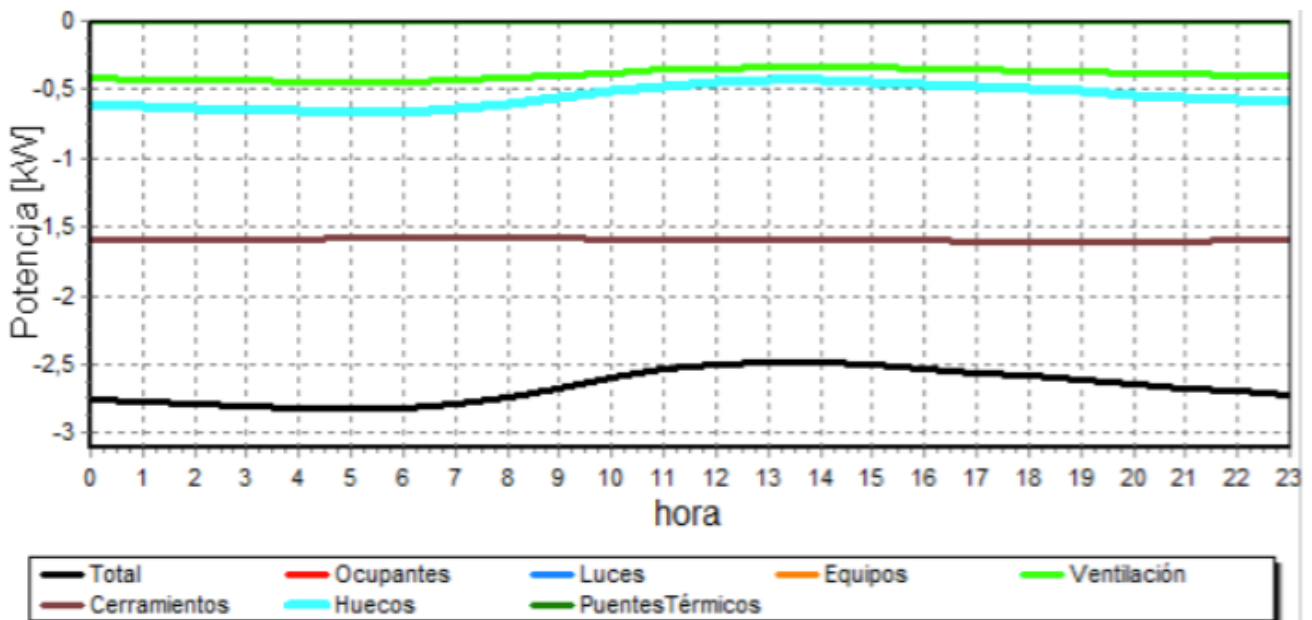

- House 4

House 4	Results
Area (m <sup>2</sup> )	35,40
Volume (m <sup>3</sup> )	98,41
Total Loads (kW)	2,33
Ratio (W/ m <sup>2</sup> )	65,86
Ventilation (kW)	0,40
Enclosure walls(kW)	1,23
Spaces (kW)	0,59
Enlargement factor (kW)	0,11

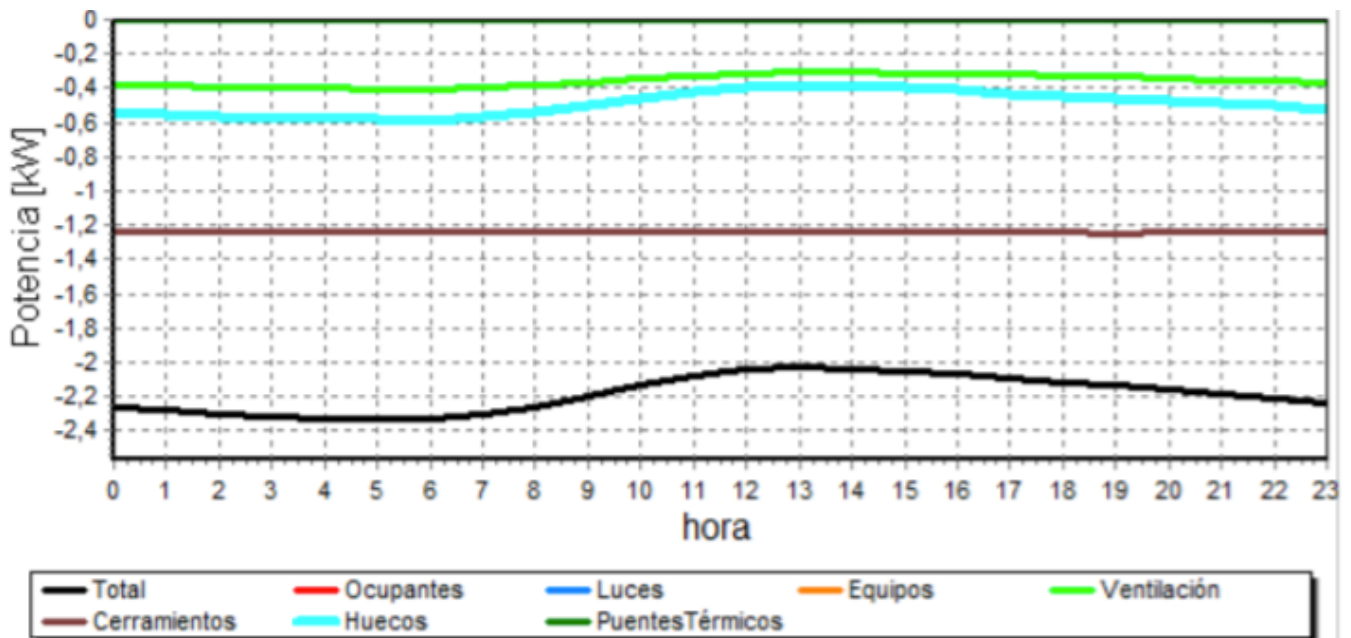

- House 5

House 5	Results
Area (m <sup>2</sup> )	36,32
Volume (m <sup>3</sup> )	100,97
Total Loads (kW)	2,35
Ratio (W/ m <sup>2</sup> )	64,73
Ventilation (kW)	0,41
Enclosure walls(kW)	1,24
Spaces (kW)	0,59
Enlargement factor (kW)	0,11

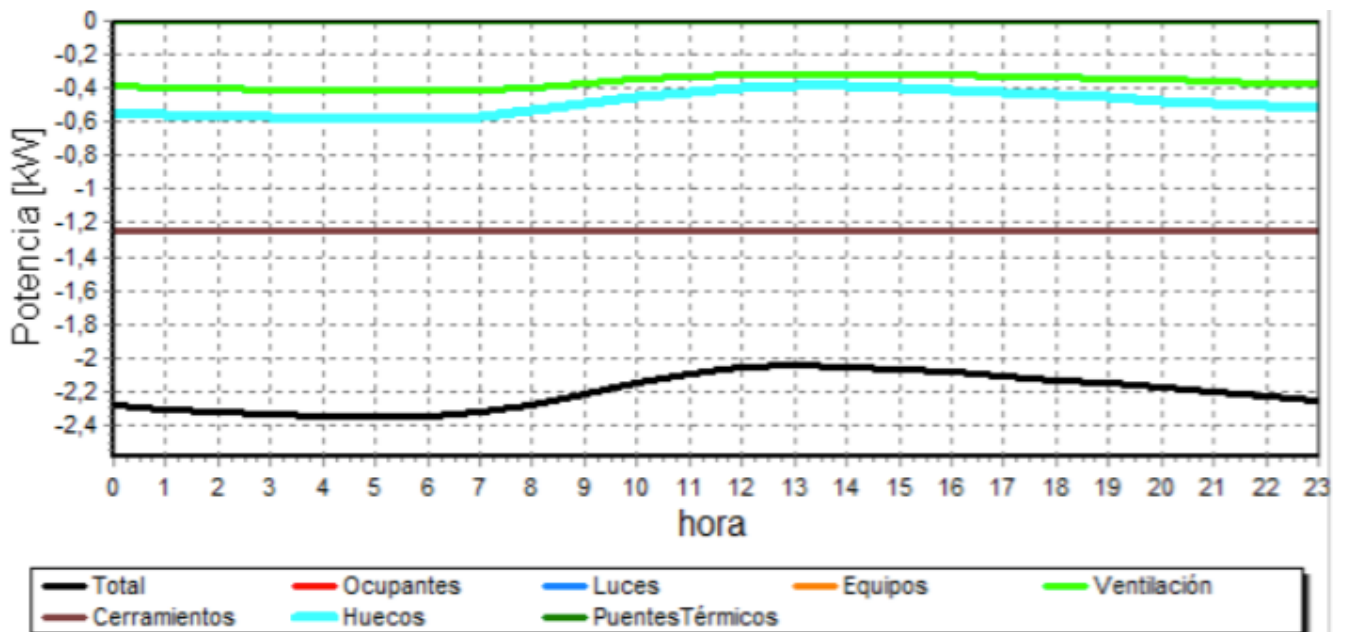



- House 6

House 6	Results
Area (m <sup>2</sup> )	38,77
Volume (m <sup>3</sup> )	107,78
Total Loads (kW)	2,75
Ratio (W/ m <sup>2</sup> )	70,93
Ventilation (kW)	0,44
Enclosure walls(kW)	1,59
Spaces (kW)	0,59
Enlargement factor (kW)	0,13

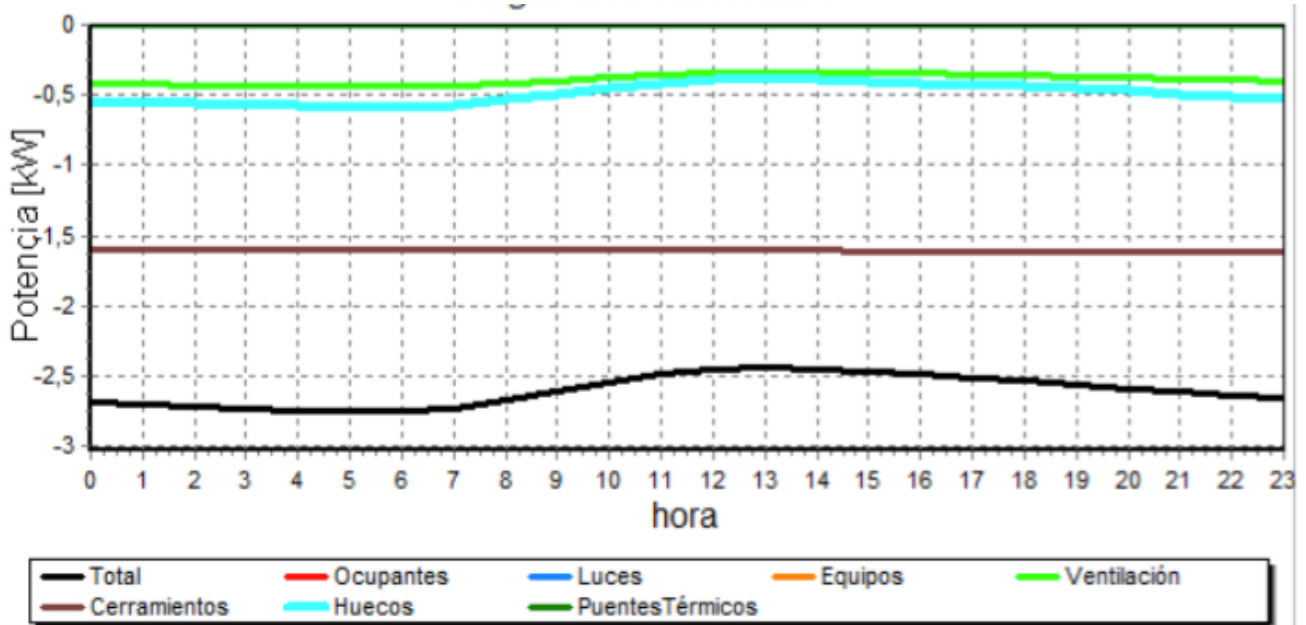

- House 7

House 7	Results
Area (m <sup>2</sup> )	58,74
Volume (m <sup>3</sup> )	163,30
Total Loads (kW)	6,14
Ratio (W/ m <sup>2</sup> )	104,44
Ventilation (kW)	0,67
Enclosure walls(kW)	4,33
Spaces (kW)	0,85
Enlargement factor (kW)	0,29

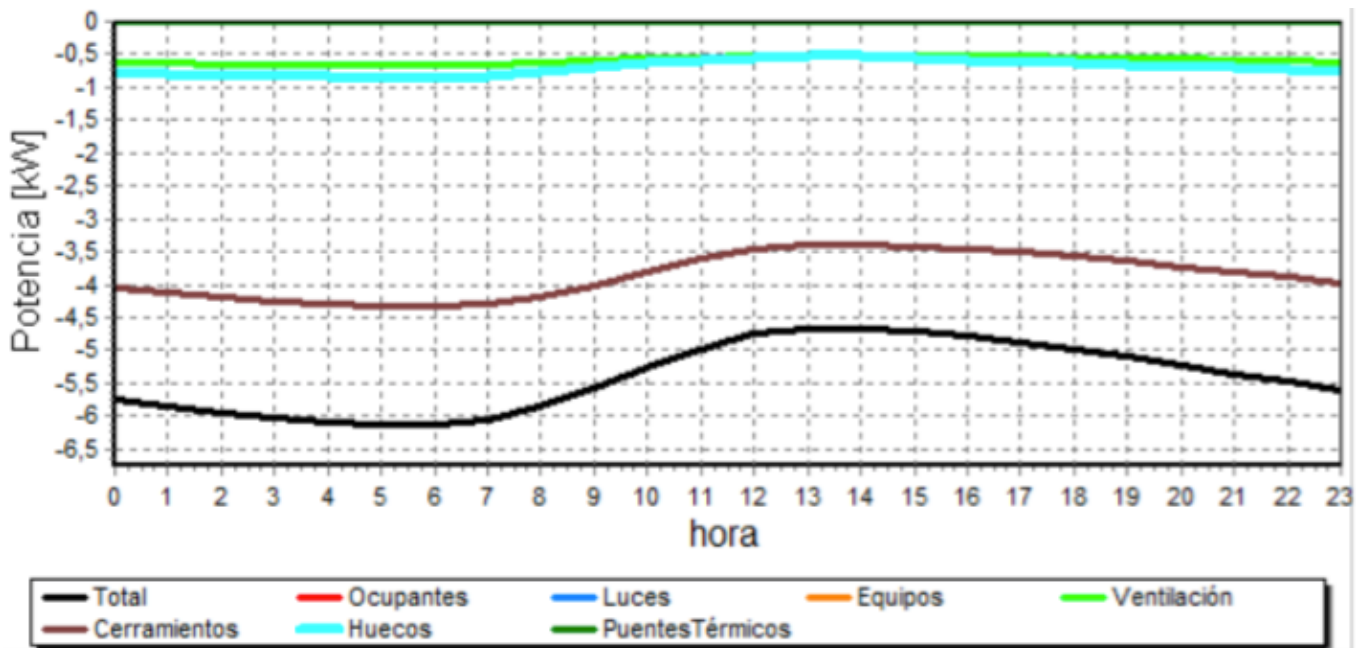

- House 8

House 8	Results
Area (m <sup>2</sup> )	32,18
Volume (m <sup>3</sup> )	89,46
Total Loads (kW)	3,99
Ratio (W/ m <sup>2</sup> )	123,99
Ventilation (kW)	0,37
Enclosure walls(kW)	3,00
Spaces (kW)	0,44
Enlargement factor (kW)	0,19

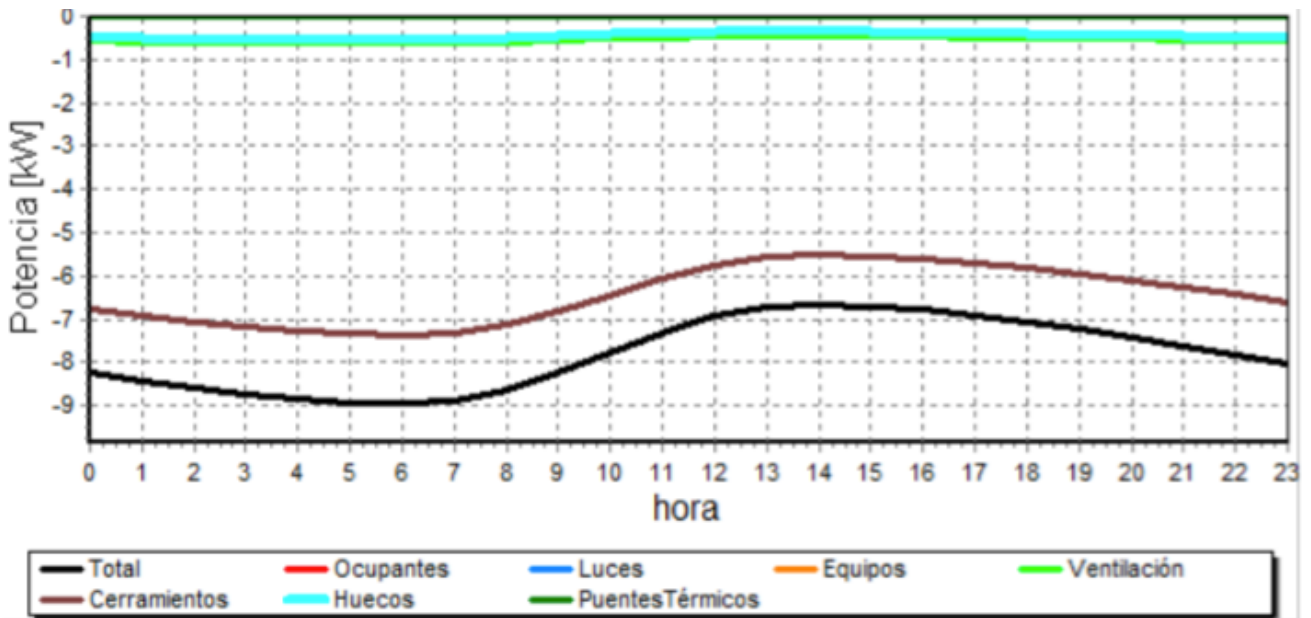

- House 9

House 9	Results
Area (m <sup>2</sup> )	40,68
Volume (m <sup>3</sup> )	113,09
Total Loads (kW)	4,68
Ratio (W/ m <sup>2</sup> )	115,13
Ventilation (kW)	0,46
Enclosure walls(kW)	3,56
Spaces (kW)	0,44
Enlargement factor (kW)	0,22

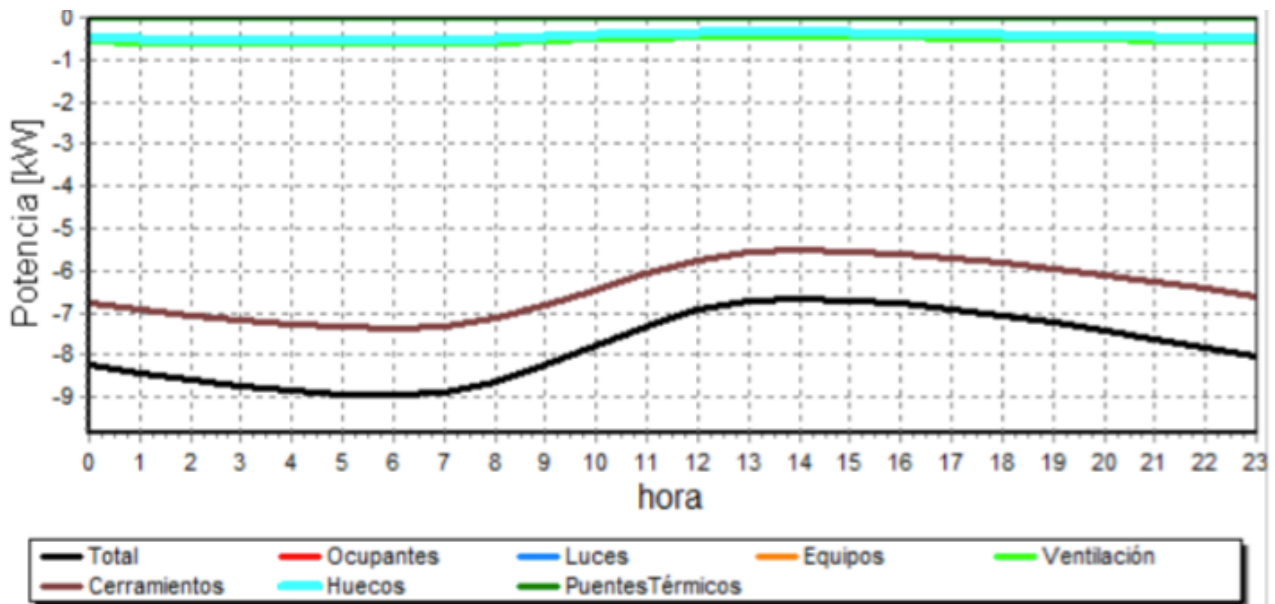

- House 10

House 10	Results
Area (m <sup>2</sup> )	53,82
Volume (m <sup>3</sup> )	149,62
Total Loads (kW)	8,95
Ratio (W/ m <sup>2</sup> )	166,32
Ventilation (kW)	0,61
Enclosure walls(kW)	7,35
Spaces (kW)	0,56
Enlargement factor (kW)	0,43

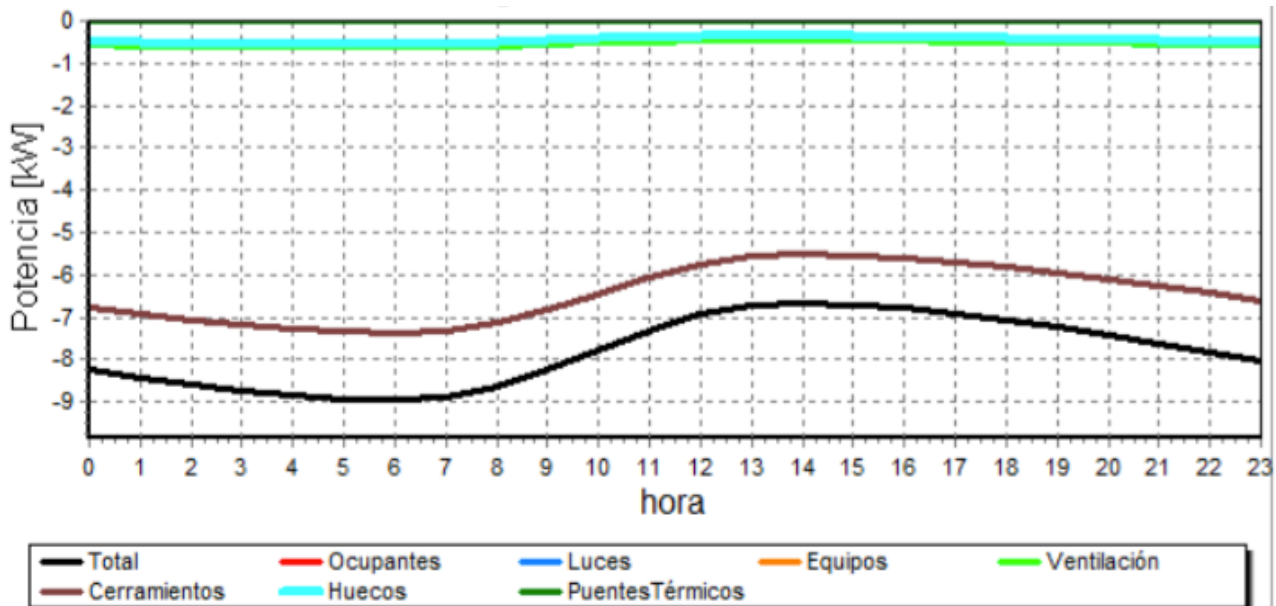

- House 11

House 11	Results
Area (m <sup>2</sup> )	53,82
Volume (m <sup>3</sup> )	149,62
Total Loads (kW)	8,95
Ratio (W/ m <sup>2</sup> )	166,32
Ventilation (kW)	0,61
Enclosure walls(kW)	7,35
Spaces (kW)	0,56
Enlargement factor (kW)	0,43

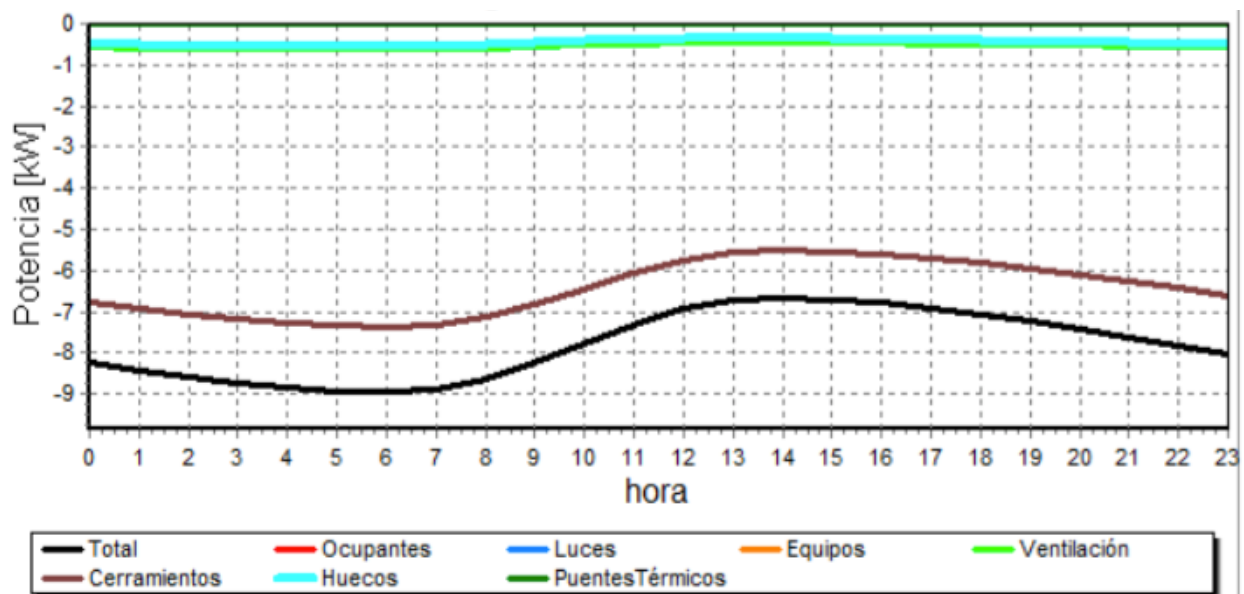

The following graphic shows the demand for the building over a year.

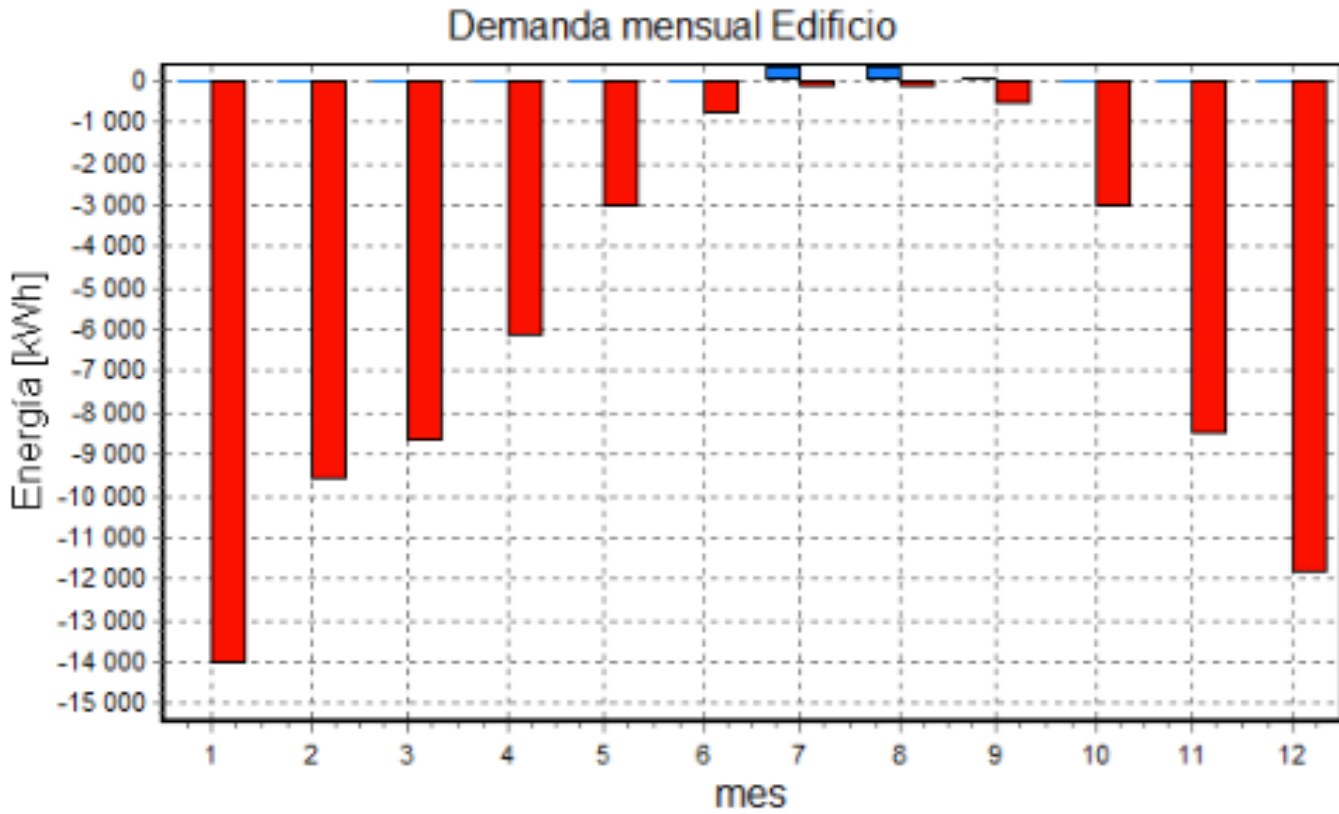

## 6. Calculation of underfloor heating

### 6.1 Initial data

To determine the characteristics of the installation of underfloor heating has been taken into account;

- Diameter of the pipe, a tube with an outer diameter of 16 mm will be installed.
- Outgoing temperature, i.e. the temperature at which the water enters the collection, which is determined by the boiler, and as detailed in point 5, will be 50° C.
- The average temperature of the soil, which will be 20°C, since the soil has a good thermal transmission.
- A standard surface will be chosen for all the houses, which will be of an average of 43,19 m<sup>2</sup>, so as not to oversize the installation.
- A thermal power of 4.894,72 W, since there will be no distinction between rooms and the same distribution will be installed in all rooms.

### 6.2 Calculation of specific heat

In this chapter the needed specific heat for each house will be calculated on the day of maximum demand.

As each home has a minimum variation of size, to simplify this calculation, we will make an average of all surfaces and this will be the one chosen for this calculation. We have a total area for heating of 475.11 m<sup>2</sup>, spread over 11 houses, which gives us an average of 43.19 m<sup>2</sup>.

As detailed in section 5, the calculations of the VpClima give us the required power on the day of maximum demand, which is 113.33 W/m<sup>2</sup>. Therefore the specific heat of 4894.72 W is per house.



Color Especifico q (W/m²)	35	40	45	50	55	60	65	70	75	80	85	90	95	100	105	110	115	120	125	130	135	140	145	150	155	160	165	170	
Temperatura media en superficie de suelo	23	24	25	26	27	28	29	30	31	32	33	34	35																
Temperatura de entrada 40°C en colectores Temperatura ambiente 20	$R_{10} = 0.01 \text{ m}^2/\text{W}$ Cerámico / Píxeles desnudos	33	33	33	33	33	33	33	33	33	33	33	33	33	33	33	33	33	33	33	33	33	33	33	33	33	33	33	33
	$R_{10} = 0.05 \text{ m}^2/\text{W}$ Madera fina y lino	48.0	35.0	25.0	21.0	20.0	20.0	20.0	20.0	20.0	20.0	20.0	20.0	20.0	20.0	20.0	20.0	20.0	20.0	20.0	20.0	20.0	20.0	20.0	20.0	20.0	20.0	20.0	20.0
	$R_{10} = 0.10 \text{ m}^2/\text{W}$ Madera espesa media y moquetas finas	48.0	35.0	25.0	21.0	19.0	18.0	18.0	18.0	18.0	18.0	18.0	18.0	18.0	18.0	18.0	18.0	18.0	18.0	18.0	18.0	18.0	18.0	18.0	18.0	18.0	18.0	18.0	18.0
	$R_{10} = 0.15 \text{ m}^2/\text{W}$ Madera gruesa y moquetas	48.0	35.0	25.0	21.0	16.0	14.0	13.0	13.0	13.0	13.0	13.0	13.0	13.0	13.0	13.0	13.0	13.0	13.0	13.0	13.0	13.0	13.0	13.0	13.0	13.0	13.0	13.0	13.0
Temperatura de entrada 45°C en colectores Temperatura ambiente 20	$R_{10} = 0.01 \text{ m}^2/\text{W}$ Cerámico / Píxeles desnudos	33	33	33	33	33	33	33	33	33	33	33	33	33	33	33	33	33	33	33	33	33	33	33	33	33	33	33	
	$R_{10} = 0.05 \text{ m}^2/\text{W}$ Madera fina y lino	48.0	35.0	25.0	21.0	20.0	20.0	20.0	20.0	20.0	20.0	20.0	20.0	20.0	20.0	20.0	20.0	20.0	20.0	20.0	20.0	20.0	20.0	20.0	20.0	20.0	20.0	20.0	
	$R_{10} = 0.10 \text{ m}^2/\text{W}$ Madera espesa media y moquetas finas	48.0	35.0	25.0	21.0	19.0	18.0	18.0	18.0	18.0	18.0	18.0	18.0	18.0	18.0	18.0	18.0	18.0	18.0	18.0	18.0	18.0	18.0	18.0	18.0	18.0	18.0	18.0	
	$R_{10} = 0.15 \text{ m}^2/\text{W}$ Madera gruesa y moquetas	48.0	35.0	25.0	21.0	16.0	14.0	13.0	13.0	13.0	13.0	13.0	13.0	13.0	13.0	13.0	13.0	13.0	13.0	13.0	13.0	13.0	13.0	13.0	13.0	13.0	13.0	13.0	
Temperatura de entrada 50°C en colectores Temperatura ambiente 20	$R_{10} = 0.01 \text{ m}^2/\text{W}$ Cerámico / Píxeles desnudos	33	33	33	33	33	33	33	33	33	33	33	33	33	33	33	33	33	33	33	33	33	33	33	33	33	33	33	
	$R_{10} = 0.05 \text{ m}^2/\text{W}$ Madera fina y lino	48.0	35.0	25.0	21.0	20.0	20.0	20.0	20.0	20.0	20.0	20.0	20.0	20.0	20.0	20.0	20.0	20.0	20.0	20.0	20.0	20.0	20.0	20.0	20.0	20.0	20.0	20.0	
	$R_{10} = 0.10 \text{ m}^2/\text{W}$ Madera espesa media y moquetas finas	48.0	35.0	25.0	21.0	19.0	18.0	18.0	18.0	18.0	18.0	18.0	18.0	18.0	18.0	18.0	18.0	18.0	18.0	18.0	18.0	18.0	18.0	18.0	18.0	18.0	18.0	18.0	
	$R_{10} = 0.15 \text{ m}^2/\text{W}$ Madera gruesa y moquetas	48.0	35.0	25.0	21.0	16.0	14.0	13.0	13.0	13.0	13.0	13.0	13.0	13.0	13.0	13.0	13.0	13.0	13.0	13.0	13.0	13.0	13.0	13.0	13.0	13.0	13.0	13.0	
Temperatura de entrada 55°C en colectores Temperatura ambiente 20	$R_{10} = 0.01 \text{ m}^2/\text{W}$ Cerámico / Píxeles desnudos	33	33	33	33	33	33	33	33	33	33	33	33	33	33	33	33	33	33	33	33	33	33	33	33	33	33	33	
	$R_{10} = 0.05 \text{ m}^2/\text{W}$ Madera fina y lino	48.0	35.0	25.0	21.0	20.0	20.0	20.0	20.0	20.0	20.0	20.0	20.0	20.0	20.0	20.0	20.0	20.0	20.0	20.0	20.0	20.0	20.0	20.0	20.0	20.0	20.0	20.0	
	$R_{10} = 0.10 \text{ m}^2/\text{W}$ Madera espesa media y moquetas finas	48.0	35.0	25.0	21.0	19.0	18.0	18.0	18.0	18.0	18.0	18.0	18.0	18.0	18.0	18.0	18.0	18.0	18.0	18.0	18.0	18.0	18.0	18.0	18.0	18.0	18.0	18.0	
	$R_{10} = 0.15 \text{ m}^2/\text{W}$ Madera gruesa y moquetas	48.0	35.0	25.0	21.0	16.0	14.0	13.0	13.0	13.0	13.0	13.0	13.0	13.0	13.0	13.0	13.0	13.0	13.0	13.0	13.0	13.0	13.0	13.0	13.0	13.0	13.0	13.0	

Table 3 - Polytherm method

Looking at the table [Table 3], we can see that it is possible to use a collector inlet temperature (flow temperature) of 50 ° C with a medium wood floor, and with a distance between pipes of 8 cm (RA8) it meets the necessary conditions. We could also have taken a temperature of 55°C with a separation between the tubes of 16 cm (RA16) to make the installation more economical because you need less tube, but with our choice gives priority to energy saving and to get more comfort.

### 6.3 Calculation of linear meters

The first step is to calculate the number of circuits that each house has, so we deduce that if the maximum surface per circuit is 8 m<sup>2</sup>, and we know that the total area of the house average is 43.19 m<sup>2</sup>, it will be necessary to install 6 circuits in each house.

The second step is to determine the linear meters of pipe to be installed, we will take into account the initial values of point 6.1, which are summarized in the following table

Data	House
Area (m <sup>2</sup> )	43,19
Thermal power (W)	4.894,72
Type of pavement	Thick wood
Specific heat (W/m <sup>2</sup> )	113,33

T <sup>a</sup> average floor (°C)	29
RA (cm)	8
m <sup>2</sup> /circuit	7,8
T <sup>a</sup> of water (°C)	50

With a distance between pipes of 8 cm and with a maximum surface per circuit of 7.8 m<sup>2</sup> we calculate that it will be necessary to install 6 circuits per dwelling, that is to say 336.88 meters of pipe in each house.

The total length is found by adding the linear meters of each circuit by multiplying by 2 to take into account the length of going and return, and adding the distance between them and the collector.

$$336,88 \times 2 = 673,76 + ( 8 \times 6 ) = 721,76 \text{ m}$$

The total pipe length of each house in the building is 721.76 meters.

#### 6.4 Calculation of the flow

In this section we will calculate the necessary flow that will circulate through the pipes of the radiant floor, to ensure the correct air conditioning, for it is chosen the data obtained from the software VpClima on the day of maximum demand in each home.

Number of house	Maximum thermal demand (kW)
House 1	5,68
House 2	5,20
House 3	2,82
House 4	2,83
House 5	2,35
House 6	2,75
House 7	6,14
House 8	3,99
House 9	4,68
House 10	8,95
House 11	8,95

The next step is to make the calculation with the following formula:

$$M = \frac{Q}{C_p \times \Delta T}$$

Where ;

M; Is the flow

Q; Is the demand for power

Cp: coefficient

$\Delta T$ : Temperature increase

For example, in the house number 1, the required flow rate would be:

$$M = \frac{Q}{C_p \times \Delta T} = \frac{5,68 \times 10^3}{4,186 \text{ J/g}^\circ\text{C} \times 10^\circ\text{C}} = 135,88 \text{ g/s}$$

And this result we move it to liters per second:

$$135,88 \text{ g/s} \times \frac{1 \text{ Kg}}{1000 \text{ g}} \times \frac{1 \text{ l}}{1 \text{ Kg}} = 0,135 \text{ l/s}$$

So for housing number 1 is needed a total flow of 0.135 l/s on the most unfavorable day. The same procedure will be performed for the rest of the dwellings:

Number of house	Maximum thermal demand (kW)	Flow (l/s)
House 1	5,68	0,136
House 2	5,20	0,124
House 3	2,82	0,067
House 4	2,83	0,056

House 5	2,35	0,056	
House 6	2,75	0,066	
House 7	6,14	0,147	
House 8	3,99	0,095	
House 9	4,68	0,112	
House 10	8,95	0,214	
House 11	8,95	0,214	
	<b>1,286</b>		Total

The final result is a total of 1.29 liters per second.

## 7. Calculation of available biomass

In this section, will be made the necessary calculations to estimate the amount of available biomass from the two species used in energy crops.

### 7.1 Planting

As explained in point 9 in the part of the project memory, planting is carried out by stakes. A good stake should measure 18-25 centimeter long and about 20-30 millimeters in diameter and have at least three shoots. It is advisable to moisten the stakes in case they have resected. In addition, application by immersion with Fention (Lebaycid) to the 1% the active product in water is necessary to eliminate possible parasites.

In most cases the orientation of the plantation depends on the best length of the edge in the plot, but as in this study, the plot is considered quite large it is necessary to emphasize the convenience of an east-west orientation, even something south east -Northern, to collect as much light as possible by increasing the photosynthetic capacity, reducing the shadow between the plants as much as possible. As the land available does not have large slopes, no contours will be realized.

The plantation can be done manually but for this study, and due to the considerable increase of the yield in the activity, a semi-mechanized plantation will be considered.

In the absence of specific plantation machinery, a low-power agricultural tractor can be used, in which two furrow openers are coupled at a distance from each other and with two

compaction rollers so that the worker simultaneously introduces the stake. The distance between the stakes can be controlled by a planting wheel.

## 7.2 Distance and density planting

The effects that seem to have a significant influence on the decision of the plantation designs and the management of the forest energy crops are the following (Instituto Nacional de Investigación y Tecnología Agraria y Alimentaria (INIA), 2007):



Figure 20 - Example of planting of energy crops in Gyöngyös

- The final constant production law, which states that the biomass yield increases with the density, although from a given density the production becomes independent of the same, which could be used to determine the maximum number of stakes per hectare in plantations.
- A competition between individuals is established with the presence of dominant and dominated trees. The cutting time should be established about these competing states, in order to avoid a decrease in the viability of the stump.
- According to Yoda's self-clear out law (1963), the total biomass per unit increases exponentially without mortality until maturity. After maturity the plants will stop their growth if the density is not reduced. Spacing and shifting should be balanced to avoid loss of competition. In addition to these two variables, others should be considered such as the duration of planting, mortality, possible rot and costs.
- In short shifts, high densities are used, with an implant scheme in single or double rows.
- In long shifts the density decreases and the rows are simple.

The reasons for selecting one density or another can be very variable: machinery available for work, biomass need to be obtained at a specific time (a spaced mass can delay its cutting time so that it supplies the material at a time of greater demand), diameter to be obtained at the time of the cut and shift, limitations on the capital invested, etc.

The plantation distance chosen for this study is 2.5 m by 0.7 m, so the density of the plantation is 5,500 plants/ha.

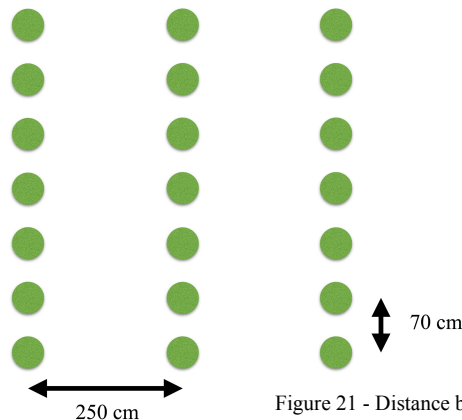

Figure 21 - Distance between trees

This means that the initial investment consists of 5500 cuttings, half of the species *Populus* and the other half of the species *Salicaceae*, plus 5% more, for possible losses, damages, death of the plant, etc.

### 7.3 Pruning

There have been numerous, to worldwide level, planting distance tested on experimental plots of these crops, with the aim of increasing yields and finding the optimum density for a given production cycle and species. This has been proven from low densities around 1,000 trees/ha to 310,000 trees/ha. In addition to planting density, different running shifts have also been tested, from annual shifts to shifts close to usual for these fast growing species (about 14 years), in order to optimize the crop and its use.

For the implantation of the energy crops in the ecovillage a first cut was chosen that was realized at the age of three years and the next every 2 year until completing the turn of 21 years, in the last cut is also included the process of removing the stumps. The process of removing the stumps is that this tree after the pruning leaves part of the trunk and the root under the surface of the lands that normally have to clear. The process of removing the stumps consists of extracting them from the ground and filling the gaps during the clearing of the

land. For the analysis of the costs, the model with the different types of irrigation (drip and blanket) has been considered.

To obtain a sufficient biomass production a density of 5,500 plants/ha was chosen.

The dry tons of the first cut are difficult to predict because they influence different factors and not all species are the same, so for calculations we will take the means of the ranks of grades according to a study by Montoya Oliver.

Quality	Since	To	Average
I	77,3	88,3	82,8
II	56,70	69,30	63,00
III	44,10	56,70	50,40
IV	31,50	44,10	37,80

Taking our general quality as reference number I.

Year	Diameter	Labour	Possibility (th/ha)	Possibility (ts/ha)
0		Level and subsoiling		
0		Plantacion y abonado		
2		Fertilization		
3	8 cm	Pruning	82,9	37,3
5		Fertilization		
7		Pruning	75,2	33,8
9		Pruning	75,2	33,8
11		Pruning	75,2	33,8
13		Pruning	75,2	33,8
15		Pruning	75,2	33,8
17		Pruning	75,2	33,8
19		Pruning	75,2	33,8
21		Pruning	75,2	33,8
		Removing the stumps	18,8	8,5

Being the tone produced with an assumption moisture content of 50%, while ts are considered the dry material (0%).

Thus, the average annual possibility is 16,7 ts/ ha·year.

As the plantation will not exceed its normal diameter of 8 centimeters, for better management of the wood, and its easy placement inside the boiler.

It means that at the end will be proceeded to remove the stumps. Stump biomass has been considered as 25% of the total biomass extracted in the last final cut

#### 7.4 Biomass

To calculate the amount of fuel that the boiler needs to supply heating to the different houses of the building, we use the following formula:

$$Q_{\text{comb}} = CE / PCI$$

Where:

$Q_{\text{comb}}$ , is the amount of annual combustible needed

CE, is the annual energy consumption

PCI, is the lower calorific value of the combustible

The lower calorific value of the combustible (PCI) depends on the type of combustible used. The calorific value depends on the moisture content, varies with the species, in this study we used two species (*Populus sp* and *Salix sp*) and also the part of the plant to be used. For this study, data are chosen from the IDAE. For the calculation, an average of the two species used in the energy crops is carried out and assuming that the wood will not be completely dry and that it will contain 20% moisture during its storage. The next value will be chosen;

$$PCI = 4,12 \text{ kWh/Kg}$$

As a result of that average of calorific power and the annual energy consumption calculated in point 5 with the program VPCLIMA, we obtain the consumption of biomass during a year;



$$Q_{\text{comb}} = (63932,75 \text{ kWh}) / (4,12 \text{ kWh/Kg})$$

$$Q_{\text{comb}} = 15090,47 \text{ Kg}$$

## 7.5 Viability

In order to study the feasibility of the parameters chosen above, such as the plantation frame, the pruning, etc., we must compare the amount of biomass that the boiler needs each year with the amount of biomass produced.

As described in point 7.3, the average annual capacity is 16.7 ts/ha·a year and the quantity required by the boiler is 15.1 th each year, i.e. 1 ton of excess will be produced, which is determined viable.

It is recommended that there is this excess because the pruning will not be good every year, and there will be years when the production will fall. For this reason we must have a stock for an emergency. In addition, this surplus wood can be used to repair homes or other ecovillage purposes.

## 8. Elements of the machine room

The ecovillage, as explained in point 5.1 of this document, has a common building, attached to the shed to store the biomass. This building houses all the necessary machinery to supply electricity to the entire ecovillage, and it is where the biomass boilers will be installed for the realization of thermal energy.

### 8.1 Dimensions

This building that houses the machinery is located a few meters from the main building and has an area of 64.64 m<sup>2</sup> (10.1 m x 6.4 m) to locate the boiler, the inertia tank and in general elements to carry out the installation.

To comply with the regulations and size of the installation with safety the minimum height should be 2.5 m, which this room already has, and also respecting a height of pipes and obstacles on the boiler of 0.5 m. There shall be a free space in front of the hips of at least 1 m, with a minimum height of 2 m free of obstacles.

The requirements for the machinery room, besides those shown below, are the need to have a point where to deposit the ashes produced by the biomass boiler.

## 8.2 Inertia tank

A deposit of inertia which is an accumulation deposit that has the following functions:

- Accumulates heat to be able to supply consumption tips and ensures that the boiler works constantly
- Different outputs can be derived from the tank, since it is an accumulator and exchanger at the same time.
- Can store residual heat at the time of boiler stoppage

These elements that go together to the heating systems, in the case of biomass, it does not need inertia for the range of temperatures, but for the reason of the combustion chamber. Every time the biomass boiler is started, the combustion chamber must be heated so that wood burning is chemical (the biomass boiler uses the wood gas obtained by heating the combustion chamber as combustible), this heating is done by means of an electrical resistance that is not efficient for the saving of the installation, which is a measure of great efficiency install inertia so that once we start the boiler and the power is turned on we can get the highest possible energy.

Also when the demand is finished it cannot be done as with a gas boiler in which the gas supply is cut off and the boiler is stopped, in the pellet boilers it will have to burn all the wood that is at that moment in the chamber of the combustion, and that heat we have to drive somewhere, into the tank of inertia.

To dimension an inertia tank we need to know how much energy we have to store before it is required to heat the building and so we can design a management strategy that will contain the boiler, which will always work with the deposit, and the deposit that will be from where will leave and where the hot water will flow that will travel the circuits of the building.

From the VpClima, we will obtain the graph of the necessary powers during the most unfavorable day, which corresponds to the month of February [Graph 3]. As you can see, the lowest powers are logically during the central hours of the day and rise during the night.

The graph shows the different power demand along the worst day of the year. The black line shows the sum of all the thermal loads of the different houses of the building (lights, infiltrations, etc.).

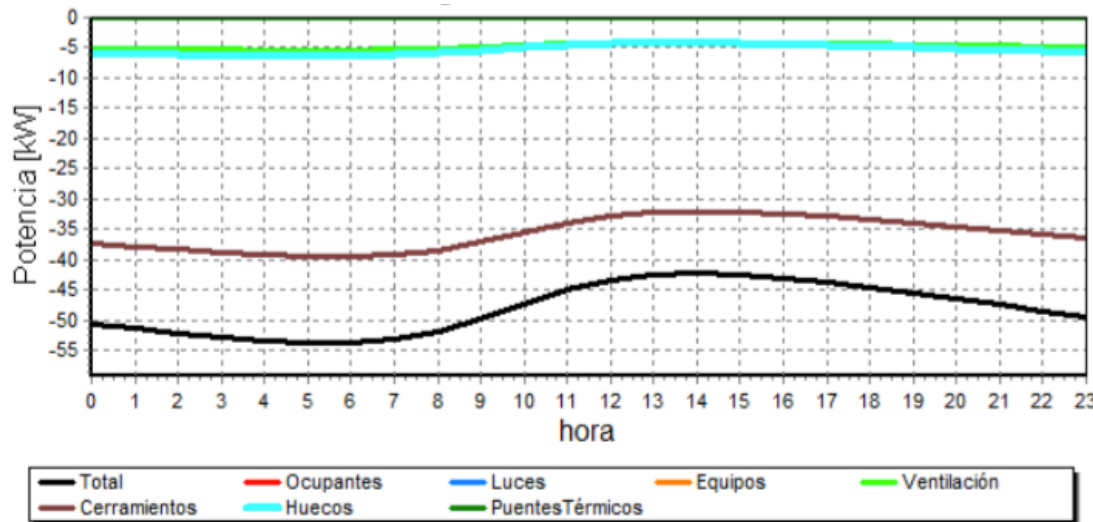

Graph 3 - Thermal demand of the building

The energy required over a period of time is, mathematically, the area below the curve between the hours to be analyzed. The computer program Vpclima gives us this graph, and obviously the line is not straight, so this area would be calculated with the integral defined between that interval that interests us with a time differential, but as it is based on an approximation of the Vpclima, we will simplify the graph joining the powers more prominent through straight lines. It is much easier to calculate the area under a geometric curve. To be able to observe it better with the points extracted from the Vpclima for the most unfavorable day is divided the area to be calculated in three, divided by three the most outstanding thermal demands.

Hour	Thermal load (kW)
0	50,01
1	51,20
2	51,97
6	53,85
7	52,80
8	51,10
14	42,40
15	42,86
16	43,65
23	50,13

Therefore we will simplify the graph in the following way;

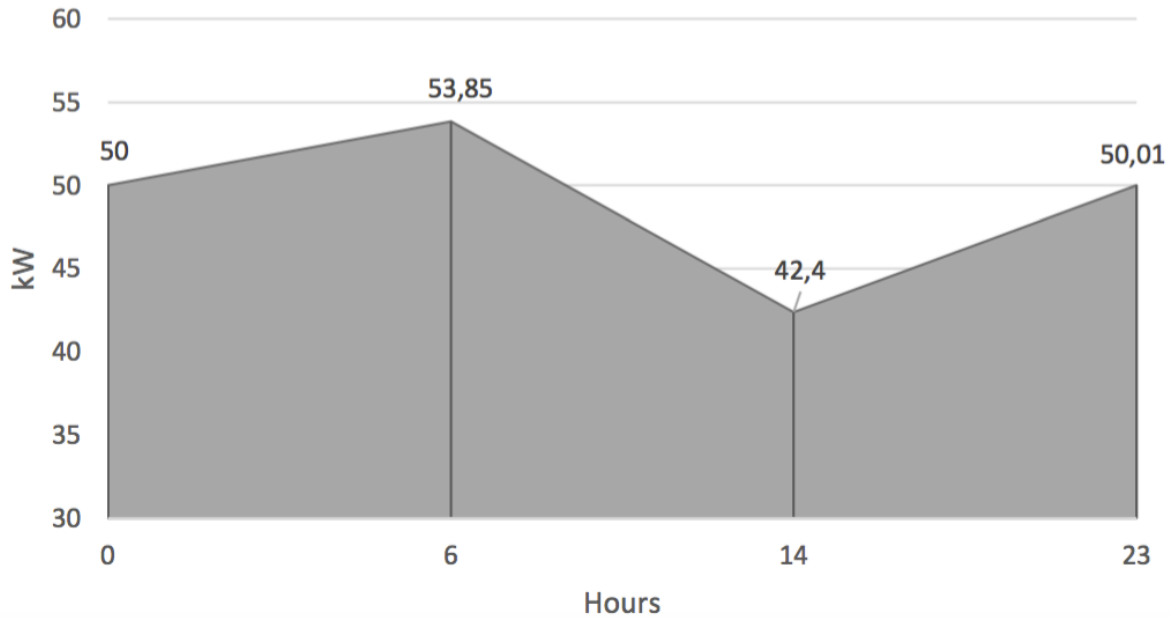

Graph 4 - Thermal demand of the building

The total energy needed for the day of greatest demand can be calculated as the shaded area, the sums of the three areas that represent the 24 hours of a day by all the houses of the building. For example the first area is of the period from 12 at night until 6 o'clock in the morning, it will be the sum of the area of the rectangle plus the area of the triangle above;

$$50,01 \times 6 + \frac{(53,85 - 50,01) \times 6}{2} = 311,55$$

Since on the vertical axis there are kW i on the horizontal axis there are hours, the calculated energy will be expressed in units of kWh. The above example will be done for the following two areas:

Period	Energy (kWh)
0 a 06	311,55
06 a 14	385,00
14 a 24	462,00
<b>Total</b>	<b>1158,55</b>

In short, on the most unfavorable day, we will need to provide 1158.55 kWh of heating energy.

The next step is to consider how much power our boiler will have, less than the 53.85 kW required to cover the peak of 6 am on the worst day of the year. Calculations will be made for a 46 kW boiler and the possible viability of this is studied:

- Boiler of 46 kW

In this case, with this power, we must subtract the 46kW we will get to each of the three sections of the boiler;

$$46 \times 24 = 1.104 \text{ kWh}$$

In this way, the energy stored by the boiler throughout the day would be:

$$1158,55 - 1.104 = 54,55 \text{ kWh}$$

- Volume of inertia tank required

It is assumed that the tank temperature is 50 °C for the start-up of the boiler and 90 °C to stop the machine. This means that the inertia tank works with a thermal jump  $\Delta T$  of 40 °C

It is also predicted that the inertia tank has a thermal efficiency  $\eta$  of 0.95. If, once the deposit is chosen, it substantially differs from this value, the necessary corrections will be made

Knowing that stored energy is calculated with;

$$E_{em} = \frac{m \times C_p \times \Delta T}{\eta}$$

- Boiler of 46 kW

$$54,55 = \frac{m \times 4,18 \times 40}{0,95 \times 3600}$$

$$m = 1.115,79 \text{ Kg}$$

And the time required for the storage of this energy under these conditions is:

$$t = \frac{E_{em}}{P} = \frac{54,55}{46} = 1,18 \text{ horas}$$

With all the above data, the next step is the choice of the inertia tank. The first characteristic that we must focus on is that this device can always provide the necessary power, even during all the hours of the most unfavorable day, as calculated, must be installed a tank of more than 1115.79 litres. In Figure 22 you can see the inertia tank of the company Lapesa that will be installed in the machine room of the ecovillage, with a quantity of 1500 litres, and its characteristics are;

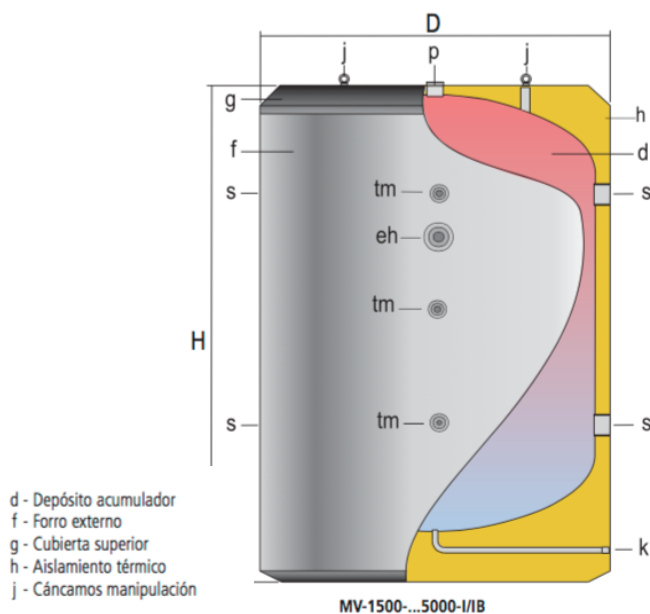

Figure 22 - Inertia tank

Características técnicas /Conexiones /Dimensiones			MV1500I
Capacidad depósito de inercia	l		1500
Temperatura máx. depósito de inercia	°C		100
Presión máx. depósito de inercia (*)	bar		6
Peso en vacío aprox.	Kg		273
Cota A: diámetro exterior	mm		1360
Cota B: longitud total	mm		1830
Cota C:	mm		160
Cota D:	mm		720
Cota E:	mm		610
Cota F:	mm		1237
Cota M:	mm		210
p:	conexión superior	"GAS/H	2
s:	conexión lateral	"GAS/H	4
e:	desagüe	"GAS/M	1-1/2
eh:	conexión lateral	"GAS/H	2
tm:	conexión sensores laterales	"GAS/H	1/2

### 8.3 Boiler

As described in the previous point number 5, through the VPclima program, the need for a thermal power in the boiler is of 53.85 kW.

Tatano is an Italian manufacturer, which markets a type of wood boilers, and the characteristics are as follows;

Boiler	data	K2102	K2104	K2106	K2108
Nominal power	kW	23	46	65	93
Capacity	L	64	116	158	200
Dimensions (mm)	width	760	860	860	860
	depth	813	979	1170	1379
	height	1030	1178	1178	1178
Chimney (mm)	diameter	150	200	200	200

Therefore the biomass boiler to be selected for this facility is the Kalorina K2104 of Tatano.

This boiler has a range of 23 to 93 kW and its main technical characteristics are:

- Body of steel boiler, which guarantees quality and durability over time.
- Minimum heat loss guaranteed by total insulation
- Horizontal heat exchanger with smoke pipes, which ensures the efficient heat exchange
- Combustion chamber of large volume with 4 wet walls
- Wide wick that allows the use of large pieces of wood
- Possibility of using liquid fuels after the application of a suitable burner



Figure 23 - Boiler of 46 kW from Tatano

A notable characteristic that will help users of ecovillage homes is that this boiler stands out for its technology, and that from your home via the internet can have all the information on the operation of the boiler, if you need more wood, its full the ash box, etc, without having to move to the machine room.

#### 8.4 Pumps

The installation of a pump in the installation is very necessary, since it is a closed circuit, it does not receive external energy and only with the inertia of the heat of the water would be very slow and ineffective. The pumps have been chosen to be able to overcome the losses of



load that are in the closed circuits and to be able to work with the required flow calculated previously in the point 6.4.

In this section the necessary power of the pump to be installed will be calculated. The first place is to take into account that the pipe through which the fluid circulates produces a friction, because the pump must overcome it to achieve the desired objective. The keys, elbows and other accessories of the installation also produce a pressure drop.

The load loss of the pipe is calculated according to an abacus that each manufacturer must provide. It is important to know that we must select a pipe that allows us to work with a speed around 1 m/sec or less, to avoid noises in the installation. It would also be desirable not to exceed a head loss of 40 mmcda/metro

In this project we must calculate the loss of load of the circuit from the inertia tank to the installation of underfloor heating, with stainless steel pipes. To simplify the vision of the installation of the pipes, the following diagram was carried out [Figure 24].

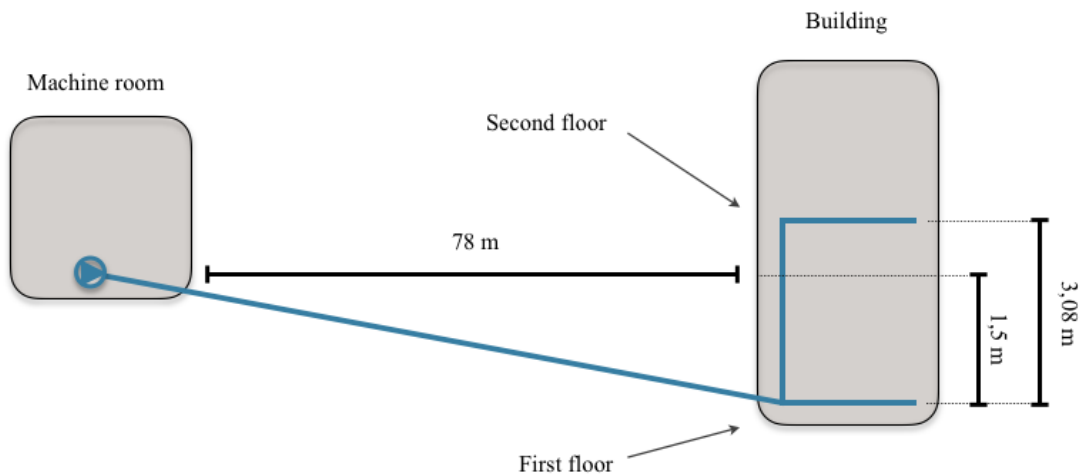

Figure 24 - Schematic of the pipe connecting the building to acclimate and the machine room

The distance that the water must cross where the boiler is located, machine room, (to the left) a total of 78 meters until with a descent of 1,5 meters, that will go in favor of the liquid during one way, and against during the return. On the right is the building to be heated, with its two floors, which have a difference of height of 3.08 meters, a significant loss of load that the pump must overcome.

### 8.4.1 Loss pump-building

To calculate the losses from the machine room to the building we observe the abacus [Table 4] , For a flow rate of 4.629,6 liters/hour (1.29 liters / second) with a pipe of 42 mm we will have a load loss of 30 mmcda/meter.

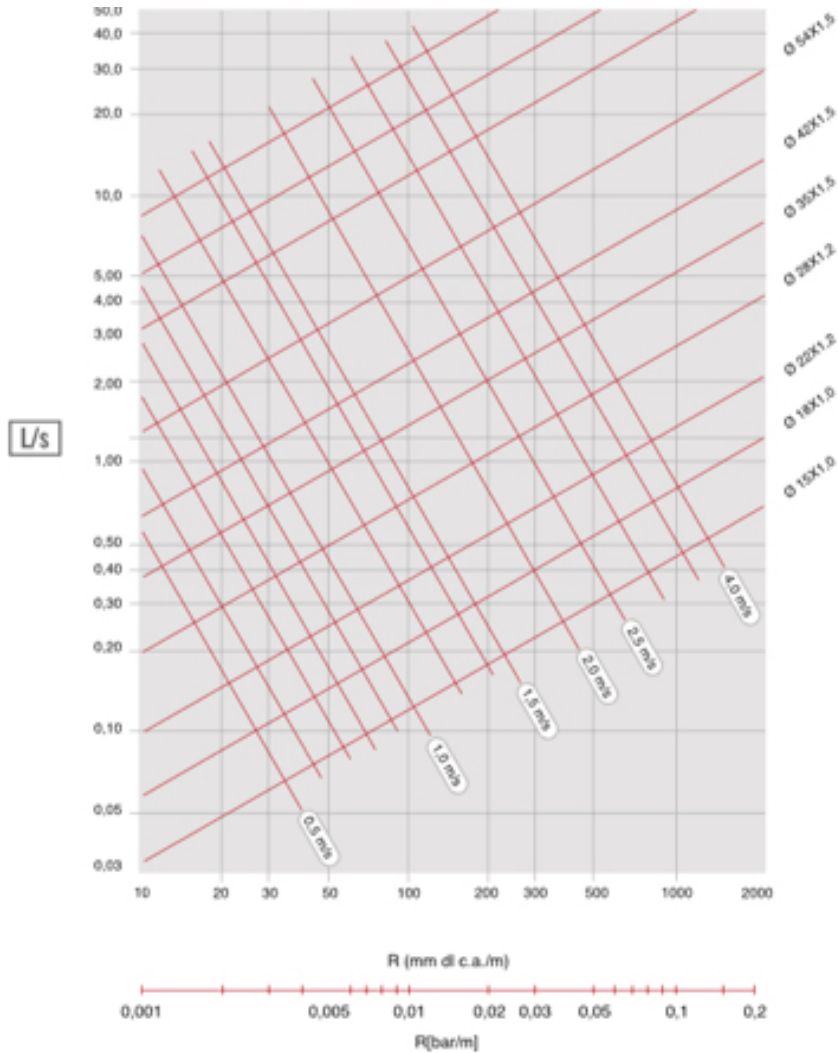

Table 4 - Abacus to determine the size of the pipe

Knowing that we have 78 meters of pipe to the collector (and another 78 of return), we calculate the total loss of load, increasing by 30% by the loss of load of the accessories that we can have in the installation (we could calculate the exact loss of load , accessory per accessory, but 30% is a generally acceptable percentage).

$$H = 30 \times ((78 + 78) \times 1,3) = 6.084 \text{ mmcda} = 6,09 \text{ mcda}$$

The result in a total of 6,09 mcda.

### 8.4.2 Loss of manifold

Corresponds to the loss of load that occurs in the manifold. To calculate these losses we will use Graph 5, for example in building 9 the required flow rate is 0.214 l/s and have six circuits.

The following figure shows the graph used:

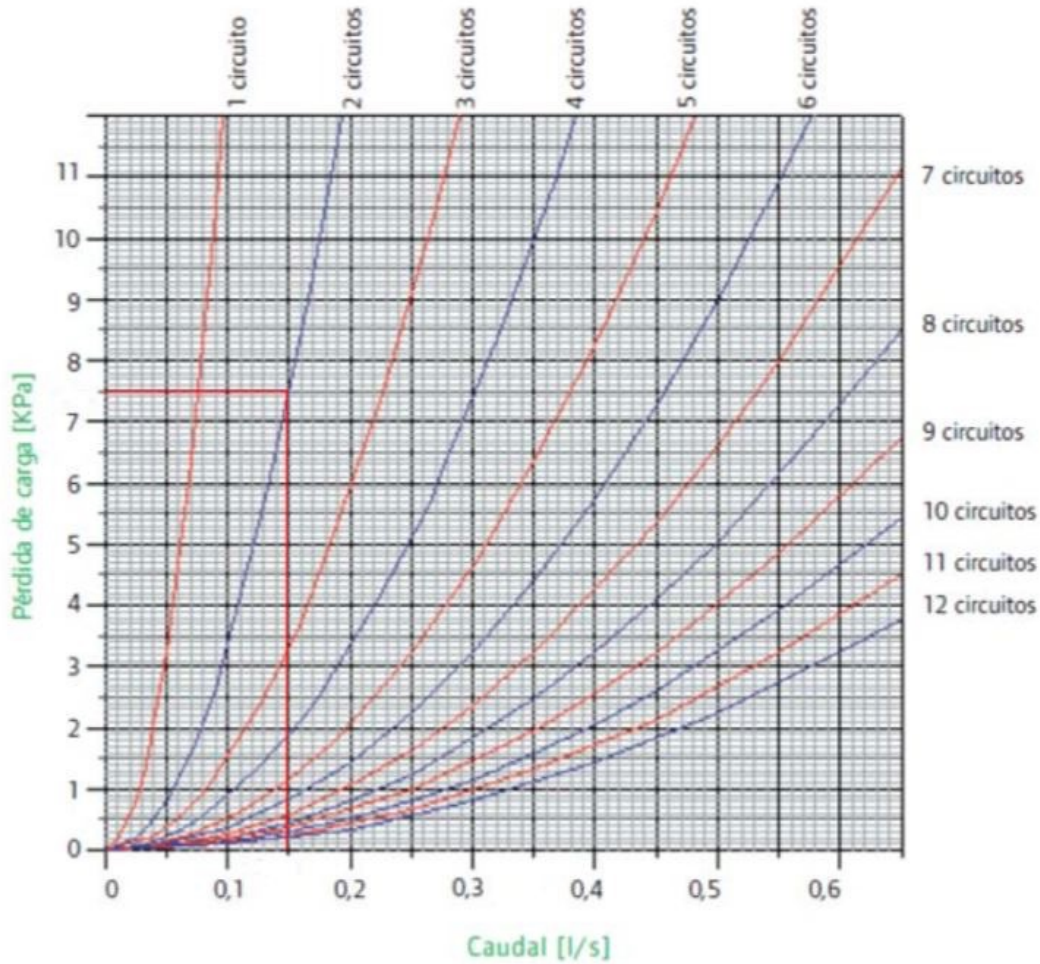

Graph 5 - Graph to determine the number of circuits

Obtaining a value of;

$$\Delta P = 2,3 \text{ KPa} = 0,234 \text{ mca}$$

The following values of the different houses are;

Number of house	Flow (l/s)	Losses (mca)
House 1	0,136	0,021
House 2	0,124	0,013
House 3	0,067	0,005
House 4	0,056	0,004
House 5	0,056	0,004
House 6	0,066	0,004
House 7	0,147	0,023
House 8	0,095	0,004
House 9	0,112	0,105
House 10	0,214	0,234
House 11	0,214	0,234
		<b>0,644</b>
		<b>Total</b>

There is a total of 0.644 mca of losses in the manifold.

### 8.4.3 Loss of height

This loss of load corresponds to that produced by the effect of gravity, with the maximum height of the installation  $H = 3.08$  [m]. The formulation is as follows:

$$\Delta P_{altura} = \rho \times g \times H = 30,18 \text{ KPa} = 3,08 \text{ mca}$$

Finally, summing all the individual losses, is obtained a maximum loss of load:

$$\Delta P_{total} = \Delta P_{height} + \Delta P_{manifold} + \Delta P_{pump-building}$$

So that gives a result of:

$$\Delta P_{total} = 6,09 + 0,644 + 3,08 = 9,81 \text{ mca}$$

#### 8.4.4 Pump selection

The pumps located in closed circuits are recirculats, to assure the movement of fluid inside the conduits.

Two of them will be connected in parallel and only one is operated. In case there is a high demand that it is necessary to heat all the houses at maximum power at the same time or if there are problems with the pump, we make sure that the water arrives perfectly.

The selected recirculating pumps are Wilo-Stratos PICO from the manufacturer Wilo [Figure 25], is a wet rotor pump with threaded connection, EC motor resistant to blocking and electronic regulation of the integrated power.

The specific characteristics of the product are as follows:

- Application in heating, cooling and air-conditioning installations from +2 ° C to +110 ° C
- Only 3 W minimum power consumption
- Indication of current power consumption or flow rate and accumulated kWh
- Additional functions: Dynamic Adapt, ventilation routine, night reduction, keyboard lock and reset function



Figure 25 - Pump Wilo-Stratos PICO from Wilo

As can be seen in Graph 6 provided by the manufacturer on this pump, a single pump can face 6 mca, so the two pumps that are connected series will be more than enough to reach 9 mca on the day of maximum demand.

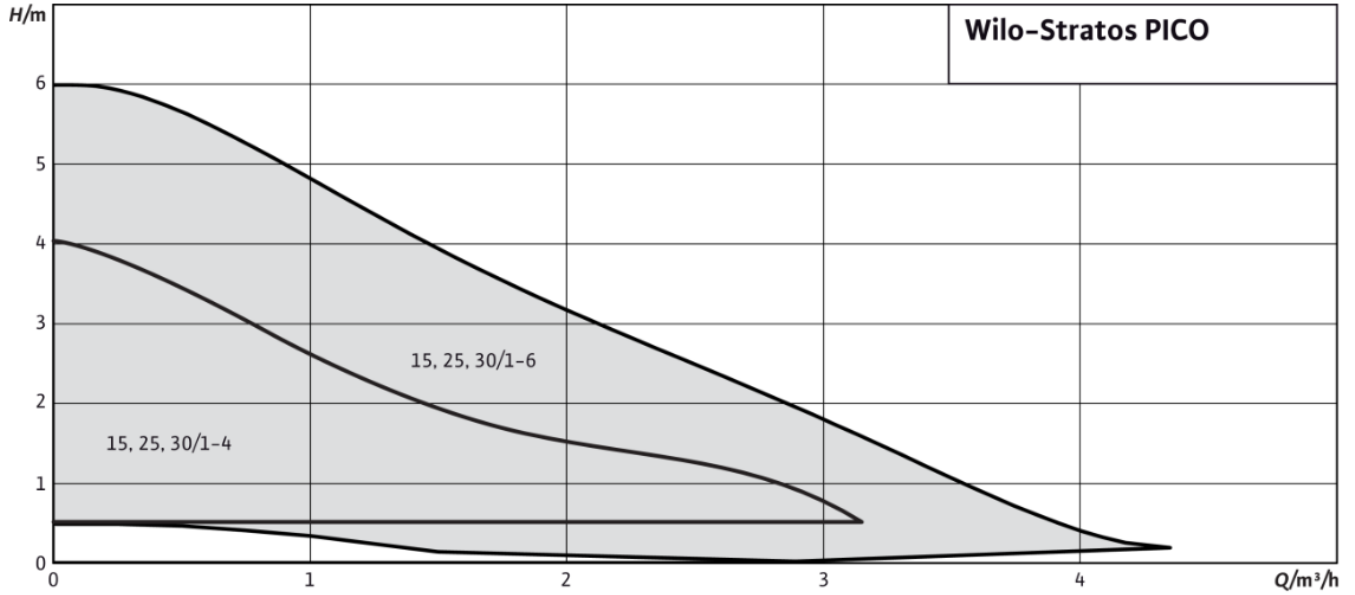

Graph 6 - Characteristics of the pump Wilo-Stratos PICO from Wilo

And the pump size scheme:

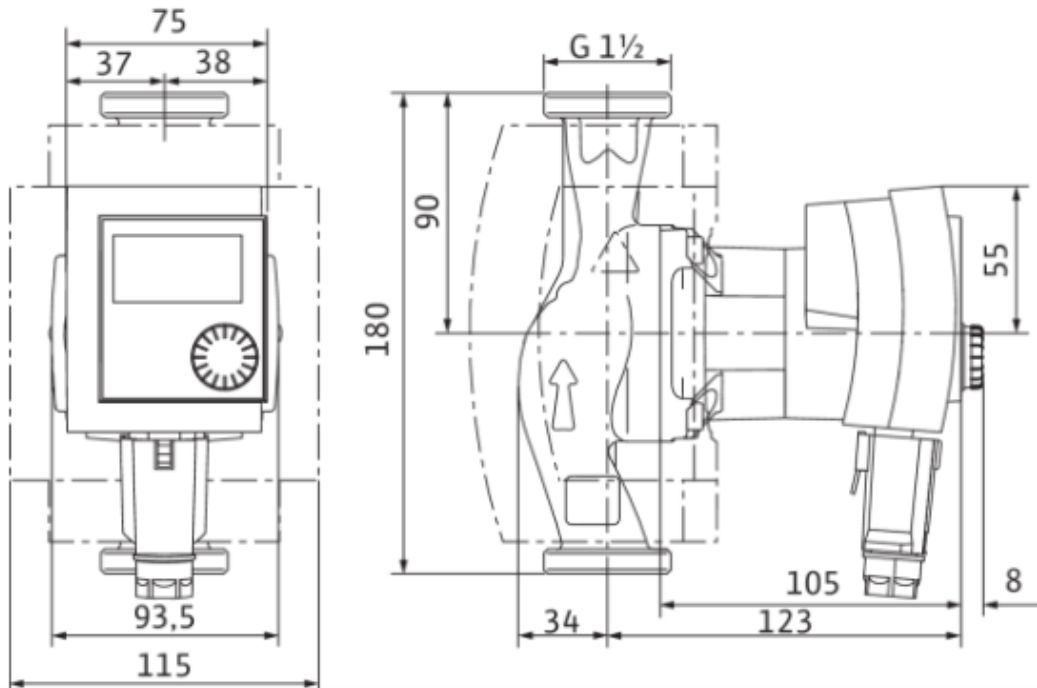

Figure 26 - Figure of the dimensions of the pump Wilo-Stratos PICO from Wilo

#### 8.4.5 Power calculation

At this point the electrical power required for the pump selected above will be calculated with the following formula:

$$P = H \times \rho \times g \times Q$$

Where;

P; Is the theoretical power

$\rho$ ; Water density

g; It's gravity

Q ; Is the flow rate of the pump

With the previous data we replaced;

$$P = 78\text{m} \times 1000 \frac{\text{Kg}}{\text{m}^3} \times 9,8 \frac{\text{m}}{\text{s}^2} \times 4,6 \frac{\text{m}^3}{\text{h}} = 0,97\text{kW}$$

If we multiply the power of the pump by 12 hours to the day of operation, a total of 4,5kWh comes out.

#### 8.5 Smoke evacuation

A fireplace for the boiler has been installed in the engine room, for the evacuation of the fumes produced by the combustion. The material of the conduit is stainless steel and the outermost part will be covered by insulation. The tube should not have welds, as this will avoid cold starts due to possible overpressures.

The flue chimney will be located on the side of the boiler, so it will cross to the deck. The chosen one is the face DINAK, and it is a self-supporting fireplace, consisting of a circular

section smoke pipe with self-supporting capacity, heat-insulated with high density rock wool, and equipped with external pre-assembled envelopes.

## 8.6 Ventilation

The boiler room needs to be properly ventilated to maintain an acceptable temperature level in the room. In addition, this system favors the combustion of the boiler and allows to dissipate gases and fumes in the installation.

By having fluids at elevated temperatures circulating inside the ducts, it will be necessary to provide the pipes and equipment with the necessary insulation to avoid large heating in the room.

The minimum section of the ventilation aperture is obtained with the following expression:

$$SV \geq 5 \cdot PN$$

Where:

SV: Free section of ventilation ( $\text{cm}^2$ ).

PN: Nominal power installed

It is advisable to make more than one opening and place them at different heights, so that currents of air are created that favor the sweeping of the room.

In the engine room will be placed two openings of 20cm diameter.







# Budget and economic analysis



**Compilation of case studies of applying renewable energies to local  
development nationally & transnationally implemented**



Co-funded by the  
Erasmus+ Programme  
of the European Union



## 1. Economical aspects of the project

This part of the study specifies the economic evaluation of the project, divided into two different subsections, the first part to calculate the different costs of the elements of the installation, etc., together with the final total cost, and the second part where will be study the viability of the project.

## 2. Budget of the installation

This chapter presents the detailed budget of the planned facility. Measurements of materials, their quantity, the unit price and resulting amount will be shown:

### 2.1 Direct costs

#### 2.1.1 Elements of the machine room

At this point we summarize the necessary elements for the installation of the boiler and its different elements of the installation from the values obtained in point number 8 of the part of the calculations. The tables show the budget in euros as well as in Hungarian Forints, on 1 May, 2017 (€ 1 = 312.4 Ft.). The necessary components are as follows;

Description	Unit	Quantity	Price Ud. (€/ud)	Total price (€)	Total price (Ft)
Boiler K2104 of Tatano	ud	1	8.040,00	8.040,00	2.511.696,00
Pump Wilo-Stratos PICO	ud	2	910,50	1.821,00	568.880,40
Inertia tank MV1500	ud	1	2.389,70	2.389,70	746.542,28
Chimney extracting smoke, DINAK	ud	1	224,00	224,00	69.977,60
Supply of rigid copper pipe of diameter 1'' (tube of 5m of length)	m	2	10,03	20,06	6.266,74
Accessories such as cutting wrenches, non-return valves, pressure gauges, safety valves, etc.	ud	6	12,42	74,52	23.280,05
MTS. TubePP. gris FASER 42	m	78	11,77	918,06	286.801,94
MTS. Tube PP. gris FASER 42	m	41,2	9,87	406,64	127.035,59

Set of adapters to the hydraulic circuit. Racor male 18-3/4 (4 Units)	ud	1	10,00	10,00	3.124,00
			<b>Total</b>	<b>13.903,98</b>	<b>4.343.604,60</b>

### 2.1.2 Radiating floor

At this point the necessary elements for the installation of the radiant floor heating are summarized from the values obtained in point number 6 of the part of the calculations. The tables show the budget in euros as well as in Hungarian Forints, on 1 May 2017 (€ 1 = 312.4 Ft.). The necessary components for the 11 houses are as follows;

Component	Description	Unit	Quantity
Perimeter insulation band	Polyethylene foam strip that is installed as a skirting board on all vertical surfaces to absorb the expansion of the pavements and eliminate the thermal bridges with the enclosures.	m <sup>2</sup>	475,11
Feed and return manifolds	Made of thermally stabilized polyamide, reinforced with fiberglass, resistant to hot water, suitable for all underfloor heating systems. Quick mounting system; Manual drain, tags and wrench are included. 9 circuits.	ud	11
Box for manifolds	Box to install the connectors in one Wall, recessed. 8 to 10 Departures.	ud	11
Tube PE 16 X1,8 mm	Intended for use in hot and cold water installations within the structure of buildings. PE-Xc-16 x 1,8 mm.	m	7.940
Floor plate PST 30	Fixing element of the tubes, maintaining a horizontality and homogeneous separation of the same	m <sup>2</sup>	421,29
Guide kink	Reinforced polypropylene curve with Fiberglass for the protection of the pipes at the exit of the mortar towards the distributor. 2 install per circuit	ud	198
Thermostat	Electronic thermostat with switch Stop / stop, for control of Ambient temperature (its placement for underfloor heating ranges from 1 to 1.5 M. ground).	ud	11
Thermostat Signal Distributor	Distributor of signals from the thermostat. Up to 10 circuits.	ud	11

Component	Unit	Quantity	Price Ud. (€/ud)	Total price (€)	Total price (Ft)
Perimeter insulation band	m <sup>2</sup>	475,11	0,65	308,82	96.475,84
Feed and return manifolds	ud	11	327,00	3.597,00	1.123.702,80
Box for manifolds	ud	11	90,75	998,25	311.853,30
Tube PE 16 X1,8 mm	m	7.940	1,07	8.495,80	2.654.087,92
Floor plate PST 30	m <sup>2</sup>	421,29	3,81	1.605,11	501.437,89
Guide kink	ud	198	0,95	188,10	58.762,44
Thermostat	ud	11	20,00	220,00	68.728,00
Thermostat Signal Distributor	ud	11	91,20	1.003,20	313.399,68
			<b>Total</b>	<b>16.416,29</b>	<b>5.128.447,87</b>

### 2.1.3 Energy crops

This section summarizes the budget that will be necessary the first year for the implementation of energy crops:

Component	Unit	Quantity	Price Ud. (€/ud)	Total price (€)	Total price (Ft)
Stakes	ud	6.000	0,38	2.280,00	712.272,00
Machinery; Clear of grass	h	5	88,00	440,00	137.456,00
Machinery; Level the land of 1ha	h	8	88,00	704,00	219.929,60
Machinery; Stake planting	h	8	67,00	536,00	167.446,40
To size; Plantation distance	h	10	16,50	165,00	51.546,00
			<b>Total</b>	<b>4.125,00</b>	<b>1.288.650,00</b>

The total direct costs are as shown in the following table;

Costs	Total price (€)	Total price (Ft)
Elements of the machine room	13.903,98	4.343.604,60
Radiating floor	16.416,29	5.128.447,87
Energy crops	4.125,00	1.288.650,00
	<b>34.445,27</b>	<b>10.760.702,47</b>

## 2.2 Indirect costs

The indirect costs will refer to the transport, installation, works, drafting of the project, etc. And will be estimated at a percentage of direct costs

Concept	Homes	Total price (€)	Total price (Ft)
Installation and commissioning (10%)	-	3.444,53	1.076.070,25
Engineering and legalization (5%)	-	1.722,26	538.035,12
Works in housing	1200 x 11 homes	13.200,00	4.123.680,00
Work in the machine room	-	4.000,00	1.249.600,00
		<b>22.366,79</b>	<b>6.987.385,37</b>

## 2.5 Summary

In the next chapter the final budget will be described. The tables show the budget in euros as well as in Hungarian Forints, on 1 May 2017 (€ 1 = 312.4 Ft.). For this total price 27% tax must be added, which is the tax rate in Hungary that applies to this type of facilities.

Description	Total price (€)	Total price (Ft)
Direct costs	34.445,27	10.760.702,47
Indirect costs	22.366,79	6.987.385,37
<b>Total</b>	<b>56.812,06</b>	<b>17.748.087,84</b>
<b>Total (+27% )</b>	<b>72.151,32</b>	<b>22.540.071,56</b>



### 3. Payback, IRR and NPV

In this section we will study the economic viability of the project compared to the use of a fossil fuel burner to produce hot water from the underfloor heating.

In the case of this project, as mentioned in the previous section, the initial investment that needs to be made is 34.445,27 € (= 10.760,702 Ft) related to direct costs and 22.366,79 € (= 6.987.385 Ft). Of the indirect costs, making a total of € 72.151,32 (= 22.540.071 Ft) by adding taxes.

To make the comparison, it is necessary to analyze the savings in the cost of gasoil C that is stopped consuming with the installation of the boiler of biomass. The biomass used will come from the planting of energy crops, so the price of this will be determined by the cost of maintenance of the plantation and the cost of the machinery for its collection and processing. Although from the first year there is no wood for the combustion, so in the first year a quantity of wood for supply of three years will have to be bought, with an approximate cost of 3500 €.

As calculating the increase of the electric energy consumption of the two pumps installed, as calculated in point 8.4.5, the total power on the day of maximum demand is 11.6kWh, so for a year they will be consumed 4248.6kW / year. Assuming a cost of € 0.085 / kWh gives a result of € 361.13 / year with an increase of 2% per year.

The saving of the consumption of diesel C (PCI = 8700Kcal / liter) will be calculated from the opp. Data of the VpClima which details a consumption of 53,85KW, and if we estimate a daily use of heating of 12 hours daily, therefore there is a total consumption of 22,316 l / year of diesel C, with a price of 0,68 € / litre and applying an annual increase of 2%.

The maintenance of the installation is estimated at 450 € / year, and an increase of 3% per year will be considered at this cost.

Year	Electric consumption	maintenance	Energy crops	fuel savings	Cash-flow	Payback
0			-3.500,00			-75.651,32
1	361,13	450,00	0,00	15.174,88	811,13	-61.287,57
2	368,35	463,50	0,00	15.478,38	831,85	-46.641,05
3	375,72	477,41	836,00	15.787,95	1.689,12	-32.542,22
4	383,23	491,73	0,00	16.103,70	874,96	-17.313,48
5	390,90	506,48	0,00	16.425,78	897,38	-1.785,08
6	398,72	521,67	0,00	16.754,29	920,39	14.048,82
7	406,69	537,32	836,00	17.089,38	1.780,01	29.358,19
8	414,82	553,44	0,00	17.431,17	968,27	45.821,09
9	423,12	570,05	836,00	17.779,79	1.829,17	61.771,71
10	431,58	587,15	0,00	18.135,39	1.018,73	78.888,36

As shown in the table above the return period of the investment will be in the 6th year, which means that it is not necessary to ensure a very long life for the boiler.

In this study, net present value is calculated of a 10-year-period with an interest rate of 5%, and a value of internal rate of return is;

$$\text{IRR} = 51.637,18\%$$

And a value of net present value is;

$$\text{NPV} = 61,1\%$$

The value obtained is much higher than the normal interest of the money, therefore this installation will be economically profitable.



**Compilation of case studies of applying renewable energies to local development nationally & transnationally implemented**



Co-funded by the  
Erasmus+ Programme  
of the European Union



# Project plans

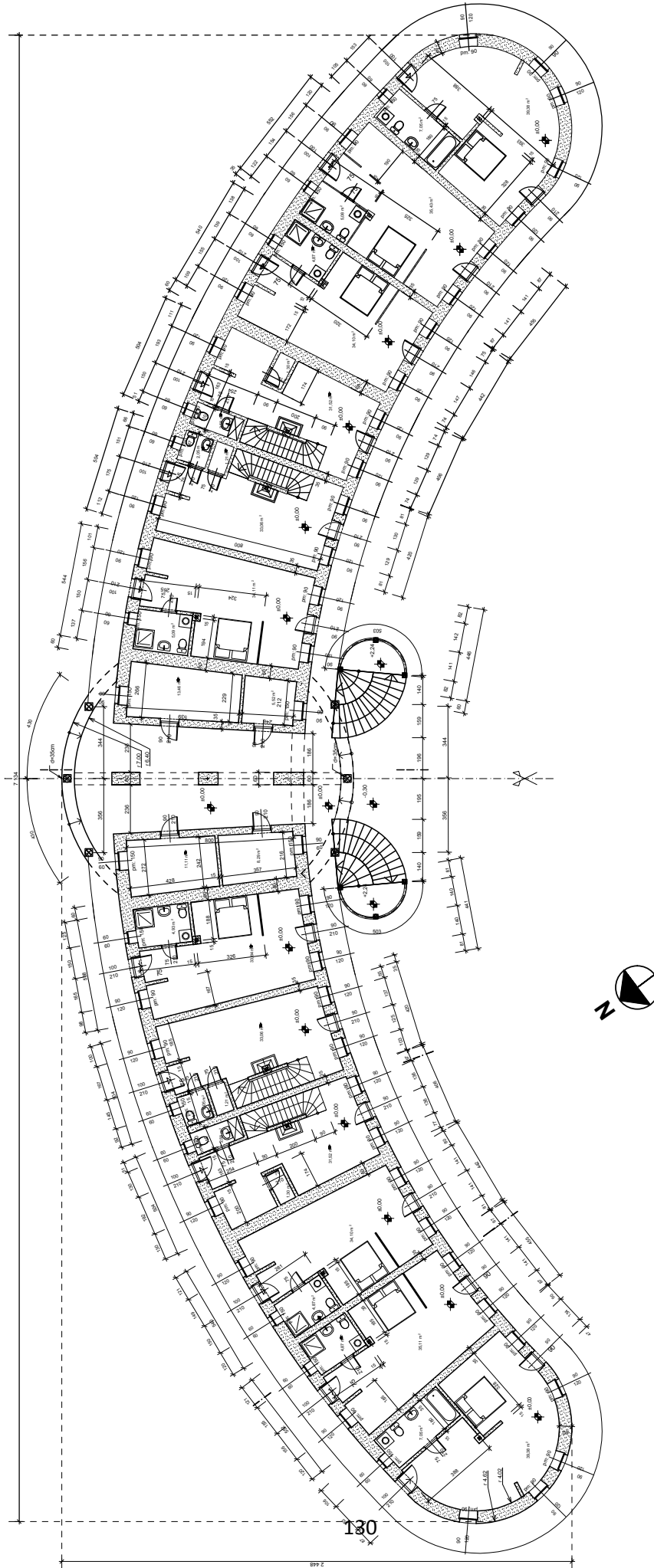

Project : The role of biomass at GAIA Ecovillage, and its utilization in establishing new eco-houses	
Localization : Gaiaheviz, okofalu dulo 25, 2193 Hungary	Plan N°1
Escalé 1:150	Date: April 2017
Plan : First floor of the building	Author : Javi Castelló Mollar
1:150	Unit: cm



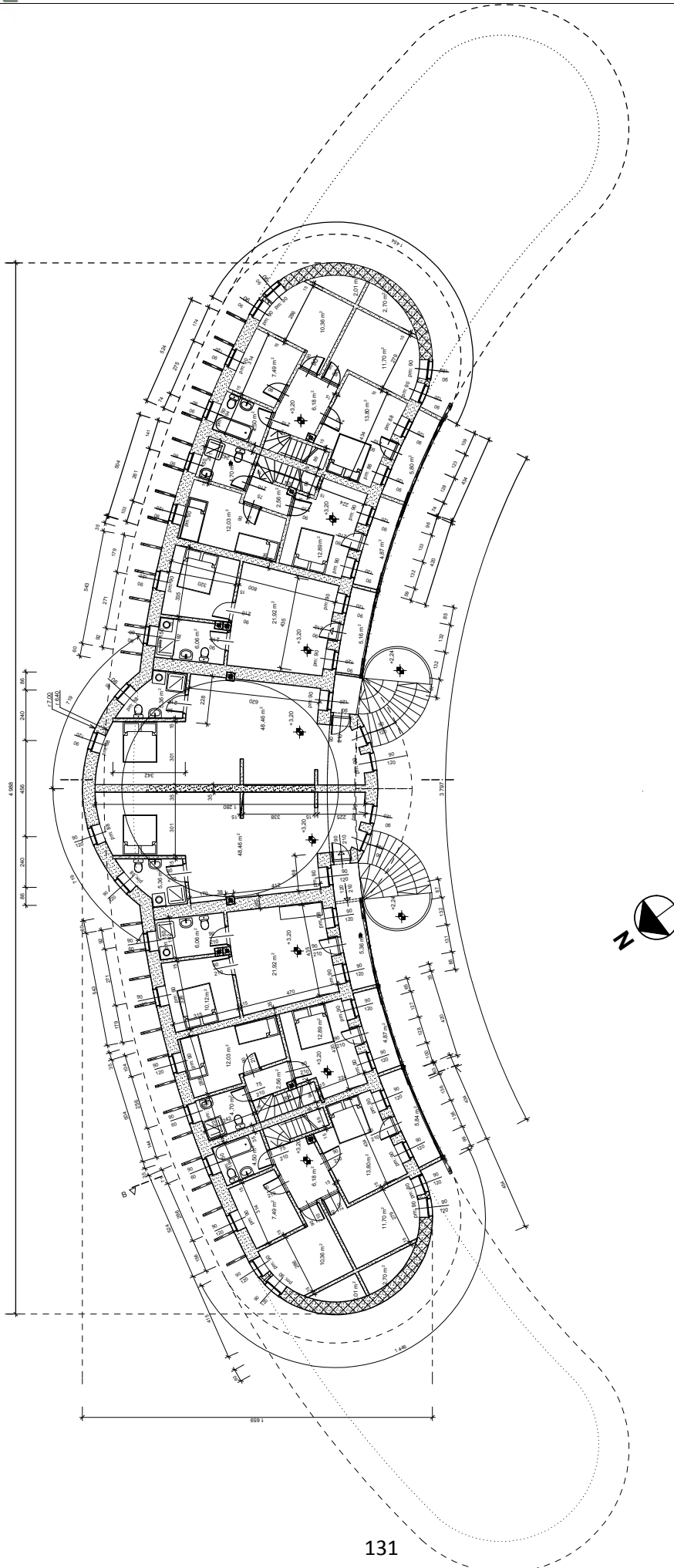

Project : The role of biomass at GAIA Ecovillage, and its utilization in establishing new eco-houses	
Localization : Gaigahéviz, ököfalú dűlő 25, 2193 Hungary	Plan N°2
Escale : Second floor of the building	Date : April 2017
1:150	Author : Gaia. Modified by Javi Castello Moliar
Unit: cm	



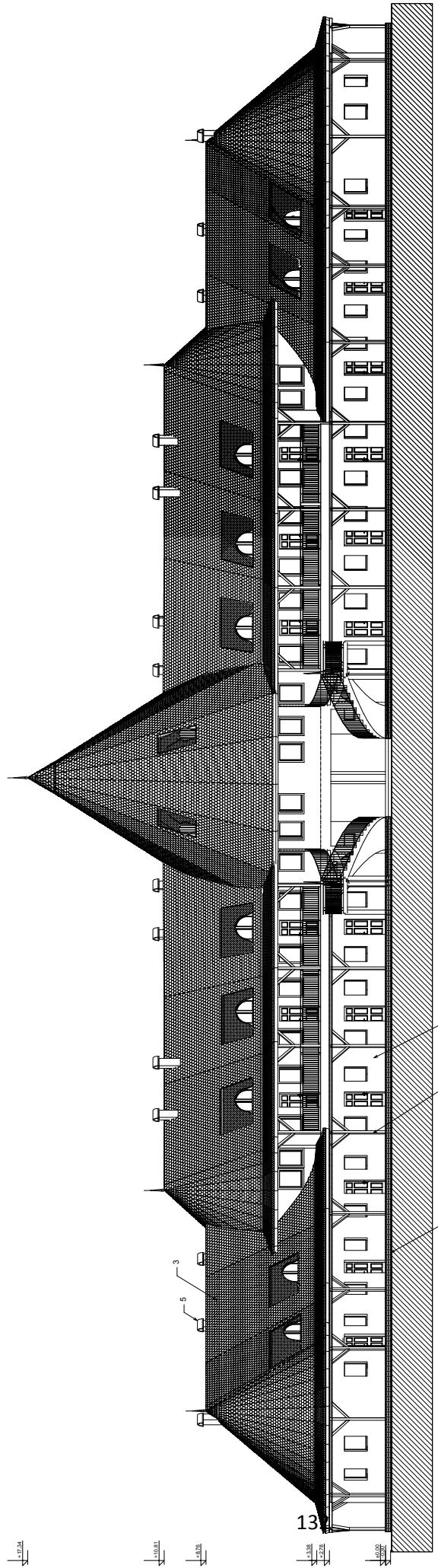

- 1 Wall
- 2 Posts of wood
- 3 Ceiling structures: Wooden boards
- 4 Factory tracts
- 5 Chimney



Project : The role of biomass at GAIA Ecovillage, and its utilization in establishing new eco-houses

Localization : Gaiahevíz, ököfalú dűlő 25, 2193 Hungary

Plan : Front of the building

Author : Gaia, modified by Ivet Castelló Mollar

Plan Nº3

Date: April 2017

Unit: m

Escale  
1:180

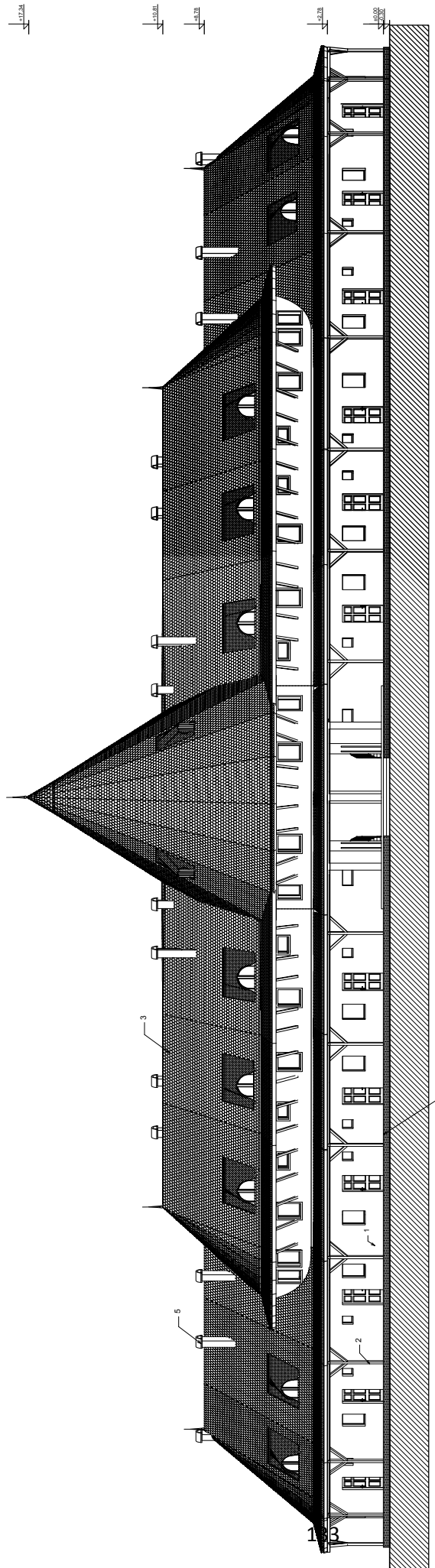

- 1 Wall
- 2 Posts of wood
- 3 Ceiling structure
- 4 Main bricks
- 5 Chimney



Project : The role of biomass at GAIA Ecovillage , and its utilization in stabilising new eco-houses

Localization : Gaiahevíz, ókofalu útól 25, 2193 Hungary

Plan : Back of the building

Author : Gaia, modified by Javi Castelló Mollar

Plan N°4

Date: April 2017

Unit: m



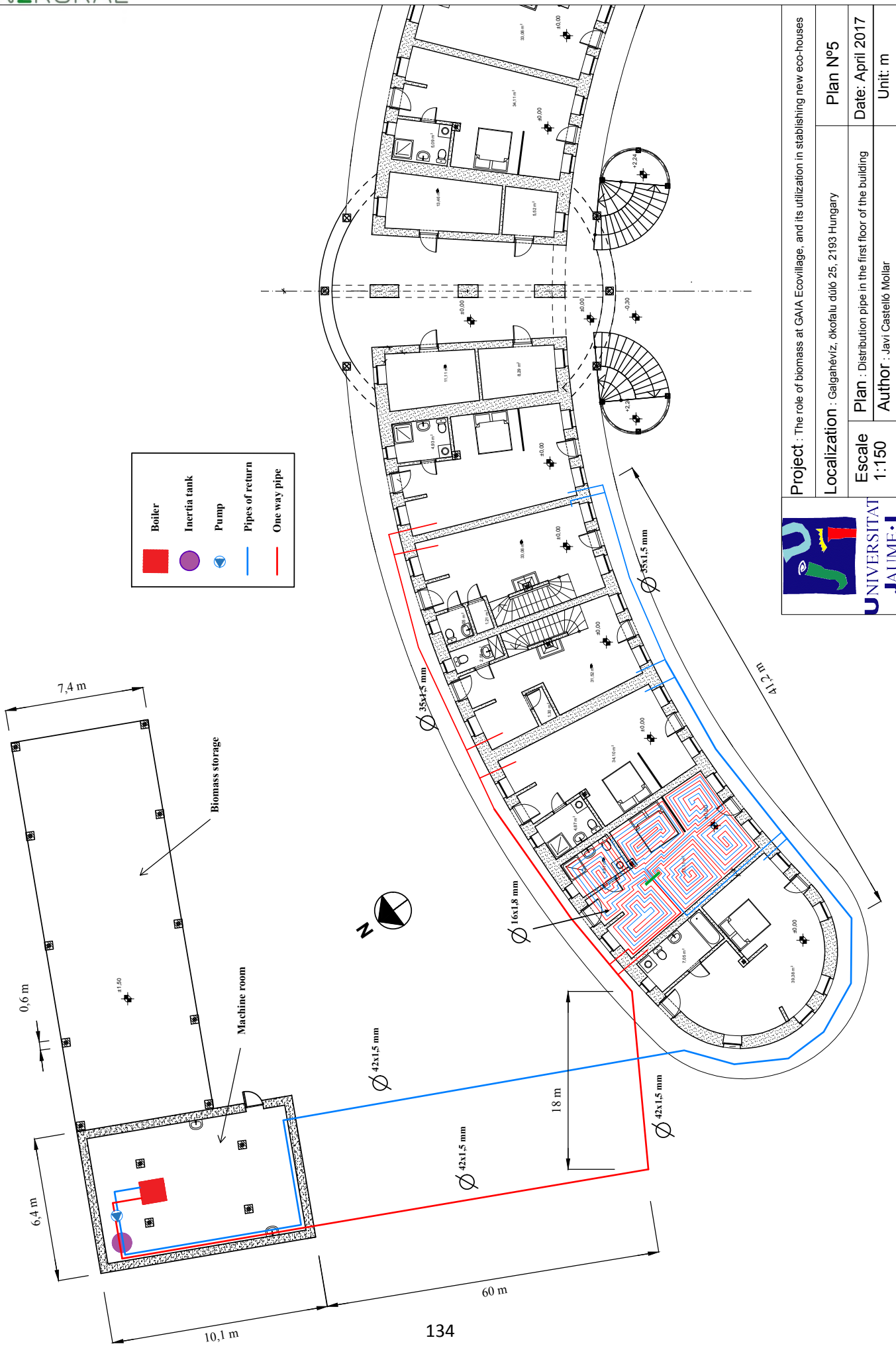

Project : The role of biomass at GAIA Ecovillage, and its utilization in establishing new eco-houses	
Localization : Galgahéviz, ökofalu dűlő 25, 2193 Hungary	Plan Nº5
Scale 1:150	Date: April 2017
Plan : Distribution pipe in the first floor of the building	Unit: m
Author : Javi Castelló Mollar	



Compilation of case studies of applying renewable energies to local development nationally & transnationally implemented



Co-funded by the Erasmus+ Programme of the European Union

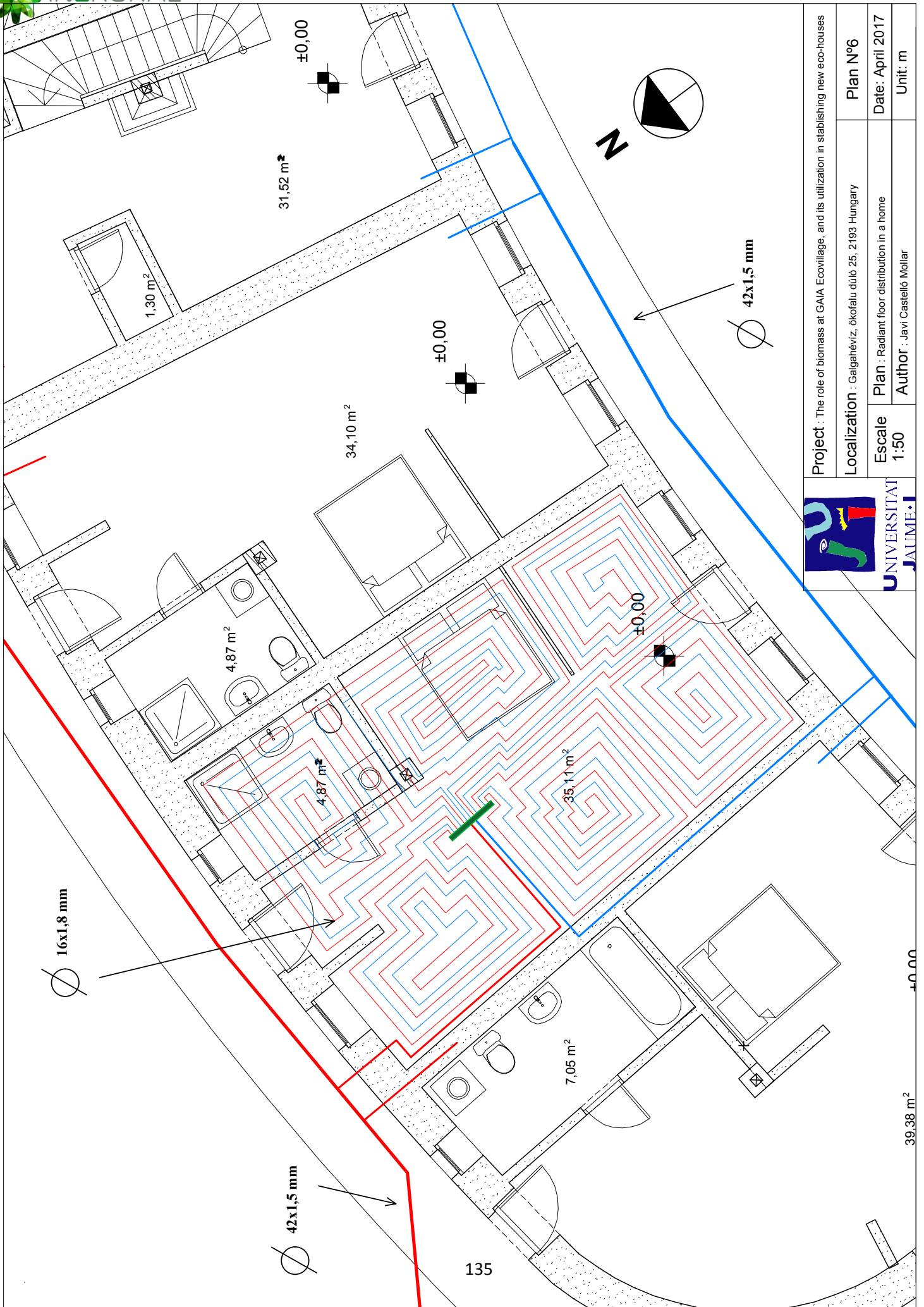

Project : The role of biomass at GAIA Ecovillage, and its utilization in establishing new eco-houses	
Localization : Galgahéviz, ököfalú dűlő 25, 2193 Hungary	Plan N°6
Escale 1:50	Date: April 2017
Plan : Radiant floor distribution in a home	
Author : Javi Castello Mollar	
Unit: m	



39,38 m<sup>2</sup>

135

16x1,8 mm

42x1,5 mm

42x1,5 mm

31,52 m<sup>2</sup>

1,30 m<sup>2</sup>

34,10 m<sup>2</sup>

4,87 m<sup>2</sup>

4,87 m<sup>2</sup>

35,11 m<sup>2</sup>

7,05 m<sup>2</sup>

±0,00

±0,00

±0,00

±0,00



**Compilation of case studies of applying renewable energies to local development nationally & transnationally implemented**



Co-funded by the  
Erasmus+ Programme  
of the European Union





**Compilation of case studies of applying renewable energies to local  
development transnationally implemented**



Co-funded by the  
Erasmus+ Programme  
of the European Union



REPORT OF THE CASE STUDY ON RENEWABLE ENERGIES TO LOCAL  
DEVELOPMENT TRANSNATIONALLY IMPLEMENTED

# Photovoltaic - wind hybrid system for energy supply of an isolated consumer

Mario Muñoz Barbero  
Universitat Jaume I  
al261349@uji.es

Case Study Tutor: Puiu Gabriel and Héctor Beltrán

Renewable energies tutor: Jose Segarra Murria

Rural development tutor: Vicent Querol

English tutor: Noémi Fiser

Professional supervisor: Valerica Rusu

General Electric

Bacau, May 2017



**Compilation of case studies of applying renewable energies to local  
development transnationally implemented**



Co-funded by the  
Erasmus+ Programme  
of the European Union



## Contents of the project

<b>1. INTRODUCTION TO THE PROJECT</b> .....	<b>7</b>
1.1. MAIN GOALS TO ACHIEVE .....	8
1.2. REACH OF THE PROJECT .....	9
1.3. GENERAL OVERVIEW OF THE AREA.....	9
1.4. STATE-OF-ART IN THE PROBLEM DOMAIN .....	11
1.4.1. PHOTOVOLTAIC AND THERMO SOLAR SYSTEMS: .....	12
1.4.2. SILICON PROPERTIES AND PHOTOVOLTAIC EFFECT: .....	13
1.4.3. PHOTOVOLTAIC CELLS TECHNOLOGIES: .....	15
1.4.4. WIND POWER TECHNOLOGIES .....	17
1.4.5. CONCENTRATION SOLAR POWER:.....	20
1.4.6. SYSTEMS DEPENDING THEIR TYPE OF CONNECTION TO THE GRID.....	21
1.4.7. ENERGY STORE SYSTEMS: .....	23
1.4.7.1. LEAD-ACID:.....	24
1.4.7.2. LI-ION BATTERY:.....	24
1.4.7.3. OTHER TYPES OF ELECTRO-CHEMICAL BATTERIES:.....	25
1.4.7.4. MECHANICAL ENERGY STORE SYSTEMS: .....	27
1.4.7.5. ELECTROMAGNETIC: .....	28
1.4.8. ELEMENTS OF A TYPICAL ISOLATED PV GENERATION SYSTEM .....	29
1.4.8.1. INVERTER .....	30
1.4.8.2. REGULATOR .....	35
1.4.9. PROTECTION ELEMENTS IN A PV SYSTEM.....	36
1.4.9.1. ELEMENTS OF PROTECTION FOR THE LINE AND SYSTEMS .....	37
1.5. DESIGN ALTERNATIVES TO BE CONSIDERED .....	39
1.6. DESCRIPTION OF THE FINAL SOLUTION.....	42
1.6.1. COMPARISON AND CHOOSING OF THE BEST DESIGN.....	42
1.6.2. FINAL DESIGN SOLUTION .....	43
1.7. IMPACT OF THE PROJECT FOR THE RURAL DEVELOPMENT .....	46
1.7.1. ENVIRONMENTAL IMPACT.....	46
1.7.1.1. LAND USE .....	47
1.7.1.2. WATER USE .....	47
1.7.1.3. ENERGY DEMAND .....	47
1.7.1.4. VISUAL IMPACT .....	48
1.7.1.5. NOISE IMPACT .....	48
1.7.1.6. AIR POLLUTION AND GREENHOUSE GAS EMISSIONS.....	48
1.7.1.7. ECOSYSTEM DISTURBANCE .....	49
1.7.1.8. RECYCLING, WASTE PRODUCTION AND MANAGEMENT .....	49
1.7.2. SOCIAL AND RURAL IMPACT.....	50
1.7.2.1. ENERGY SECURITY .....	51
1.7.2.2. RURAL ELECTRIFICATION .....	52
1.7.3. CLIMATE CHANGE MITIGATION .....	52
1.7.4. NEW JOBS AND BUSINESS OPPORTUNITIES .....	53
1.8. CONCLUSIONS .....	54
1.9. REFERENCES .....	55





<b>2. CALCULATIONS AND DESIGN.....</b>	<b>59</b>
<b>2.1. GENERAL INFORMATION .....</b>	<b>59</b>
<b>2.2. SIZING PROCESS GUIDELINE.....</b>	<b>60</b>
<b>2.3. POWER NEEDS OF THE INSTALLATION .....</b>	<b>61</b>
<b>2.4. MEASURING THE SUN AND WIND RESOURCE .....</b>	<b>63</b>
<b>2.5. SMALL WIND TURBINE SIZING.....</b>	<b>68</b>
<b>2.6. PHOTOVOLTAIC INSTALLATION SIZING .....</b>	<b>70</b>
<b>2.7. SIZING OF THE BATTERY SYSTEM .....</b>	<b>73</b>
<b>3. CHOOSING THE INVERTER AND CHARGE REGULATOR.....</b>	<b>74</b>
<b>3.1. CHARGE REGULATOR .....</b>	<b>74</b>
<b>3.2. INVERTER SIZING .....</b>	<b>76</b>
<b>4. CONNECTION BETWEEN LINES.....</b>	<b>78</b>
<b>5. PROTECTIONS.....</b>	<b>90</b>
<b>5.1. FUSES .....</b>	<b>90</b>
<b>5.2. GROUNDING.....</b>	<b>100</b>
<b>6. OTHERS.....</b>	<b>101</b>
<b>6.1. SELECTION OF SOLAR PANEL MODEL .....</b>	<b>101</b>
<b>7. DISTANCE BETWEEN PANELS ON ROOF INSTALLATION.....</b>	<b>103</b>
<b>8. ECONOMICAL ASPECTS OF THE PROJECT.....</b>	<b>109</b>
<b>8.1. BUDGET OF THE INSTALLATION.....</b>	<b>109</b>
<b>8.2. PAYBACK, IRR AND NPV .....</b>	<b>111</b>
<b>9. PROJECT PLANS .....</b>	<b>117</b>



# Memory of the project



**Compilation of case studies of applying renewable energies to local  
development transnationally implemented**



Co-funded by the  
Erasmus+ Programme  
of the European Union



## 1. Introduction to the project

This project will mainly consists of the sizing, and analysis of a PV<sup>1</sup> with wind mill hybrid system, for the purpose of satisfying the demand of a client that due to its characteristics the normal “modus operandi”<sup>2</sup> of electrical power supply would not work because of geographical characteristics, that make the connection to the grid extremely expensive, that we will be shown on the following chapters, the most profitable way for the client is the renewable solution.

Listing of the possible solutions, and weighting their pros and cons. Showing the evolution of our selection process of the solution so it can be easily understandable, and giving the main reasons of choosing one over the other based on the our criterion.

The main effect of this kind of solution will also be discussed, first on the client itself, on an economical way being this the main reason for him considering the installation. Include inside The economical evaluation is also included (in the chapter entitled Economical aspects of the project) different parameters will be examined in respect of profitability, payback and aspects such as O&M<sup>3</sup> cost etc... of the money inversion needed for the installation

Secondly the effect that could have on this kind of implementation, from a rural development point of view if it spreads around the surrounding areas, on the rural areas around, and economical-social way. A brief summary is given on the actual situation in Europe in the rural areas, and their main problems and causes.

Thirdly seeing this installation from an environmental point of view. The influence and change that this theoretical installation could have on benefiting the environment due to the reduction of GHG<sup>4</sup> to the atmosphere. Also the possible negative effects of the named installation from its production, including the GHG emissions and other possible effects on its surrounding.

---

<sup>1</sup> PV : Photovoltaic

<sup>2</sup> Modus operandi: Usual way of doing an specific process

<sup>3</sup> O&M: Operation and maintenance

<sup>4</sup> GHG: Greenhouse Gases

### 1.1. Main goals to achieve

The main goal to achieve as we have already mentioned is to accomplish the electrical energy supply of the farm that produces dairy products.

The solution that the farmer has right now is the use of a diesel engine with a generator of around **5000W** of power. The problem with this solution is that is not good enough, the whole system does not solve his basic necessities. The voltage measured at the plug sockets of the house give **160 V<sup>5</sup>** of current.

Connecting to the grid is also not a possibility, because in this scenario he has two options: to pay the construction of a proper derivation to his farm, which is very costly, or bringing a cable from the closest town and suffer an extremely amount of losses.

As we can see in this scenario the most profitable way will be the isolated renewable solution. On further chapters it will be fully explained.

A criteria list will be established in order to select the solution that best adjusts to his needs, we will prioritize:

1. Proper solution to his problem
2. More energy supply security and reliability
3. Economical
4. Environment
5. Subjective aspects like: Aesthetics, personal preference from the client etc....
6. Others

---

<sup>5</sup> In Romania the standard plug tension is at 230V

## 1.2. Reach of the project

In this project we will mainly focus on the design and calculations related to the PV with the windmill hybrid system. Design and provisional aspect such as choosing the protection elements, inverter, cable sizing etc....

The following aspects will **not** be discussed in this case study: methods of installation , civil engineering aspects of the installation, deep view of the Operation and Maintenance (O&M) , disposal at the end of the cycle of life and any set of laws of the country affecting the objective of this project<sup>6</sup>.

## 1.3. General overview of the area

The farm dedicated to the production of dairy products is located in Romania, near the city of **Bacău** in the village of **Călugăreni**. Milk and related products used for the production of the dairy products, come from the animals within the farm and from other farms in the nearby areas. The farm does not only gets from its neighbours the materials needed for the production, but also food for the animals and wood.

Călugăreni village is located deep into the Neamt county. Neamt County is at the north-east of Romania, close to the Moldavian and Ukrainian borders. Neamt county is famous because it has the highest amount of churches per square area in the world. [1] It has a population of around 470.766 people.



**Figure 1: Overview of the Neamt County. Source: Wikipedia Commons 2011**

The biggest population inside Neamt County is the city of **Piatra Neamț**, which is also the capital of the county, 36 km away from the village. The village is close to the lake Bijaz which is the largest artificial lake in Romania [2] created during the construction of the

---

<sup>6</sup> In this case, any set of laws from Romania affecting the PV installation

**Bicaz-Stejaru** hydro-plant, the named dam has a production capability of 210 MW, generating around 500 GWh every year .

It is close to the protected national park of **Ceahlău**, which was declared as a national park in 2000, and has a surface area of around 83,96 km<sup>2</sup> or 8.396 ha<sup>7</sup>.

Piatra Neamt the capital of the county, with a population of around 85.000 people and its economy is mainly based on industry plants around the area.

In Figure 2 we can see the overall location of the village (Red) in comparison with Piatra Neamt (Blue) and the national park Ceahlău (green). We can also see the mentioned lake on the map.

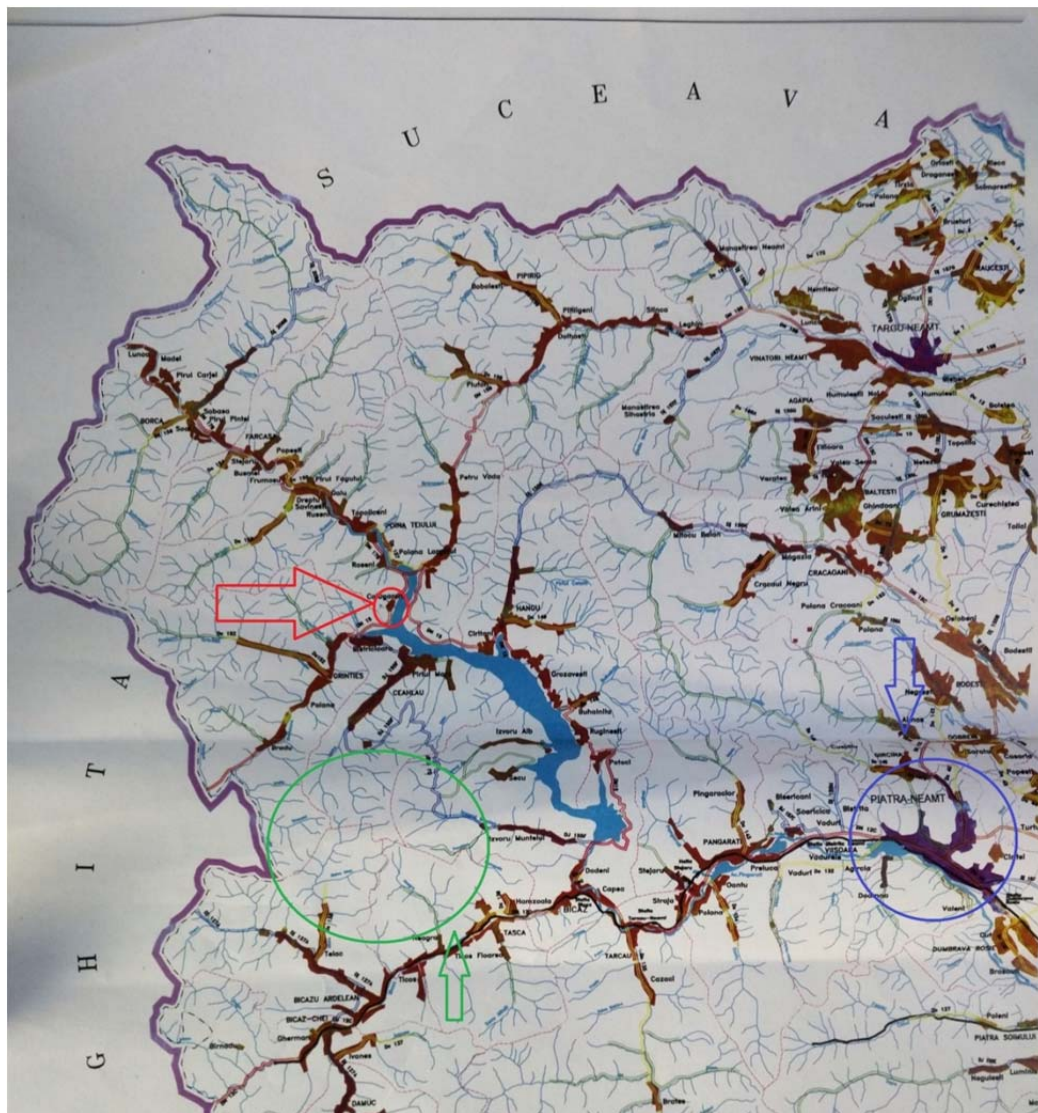

**Figure 2: Location of the village**

<sup>7</sup> Ha: hectare

#### 1.4. State-of-art in the problem domain

As mentioned before in the main goals of this case study, the problem to is the power supply to a farm isolated from the electrical grid because of the geographical position.

The main problems to solve are the following points:

- Power supply: Right now the solution that the owner has is insufficient<sup>8</sup>
- Security for the electrical uses of the farm related to production

For this kind of situation in which, due factors mentioned before, and by the owner's own words, the connection to electrical grid is out of the equation. Then for this kind of situation, the solution is an off-grid generation power supply.

Off-grid generation can be achieved with the use of Photovoltaic panels. Only with the modelling of the panels we would fall short, due to the stochastic process that is solar irradiation, because aspects such as day and night cycle, clouds, weather etc... can affect it.

The night and day cycle forces the use of some kind of energy store system (ES) for making the solution viable. So batteries will also be part of the proposed solution.

As mentioned before the randomness of the solar irradiation lowers the system electricity supply security and reliability, and as established before, in our criteria one of the main points are security and reliability for him being able to secure his production system, so a windmill will be set in addition to the photovoltaic panels to raise and secure energy supply continuity.



**Figure 3: A hybrid system: PV+WM<sup>9</sup>**

<sup>8</sup> See part "1.1 Main goals" for further information



In addition, the farm is used during the winter day, so a heating system is in use. The system actually implemented is a boiler which works with wood. A collector will be also proposed (as an extra) to give hot water service to the house for heating purposes. On the economical part of the case study we will see if the addition of this module will be profitable or not.

Therefore the solution will be a hybrid system : A photovoltaic panel and in addition a wind mill power system as the title of this project already mentioned.

Let's see then a brief overview of the technology for this kind of systems .

#### 1.4.1. Photovoltaic and thermo solar systems:

Sun's energy is the most abundant energy source we have on this planet 173,000 terawatts of solar energy strikes the Earth continuously. That is more than 10,000 times the world's total energy use. [3]

The technologies available for the use of the sun's energy can be divided into two categories for electrical generation:

- Photovoltaic technologies (Direct)
- Solar concentration radiation (indirect)



**Figure 4: Example of solar technologies. Photovoltaic solar panel (Left) CSP (Right)**

Also, only the heat provided from the sun is used, with the purpose of heating water for its use. This kind of technology is called solar thermal collector.

---

<sup>9</sup> PV+WM stand for : Photovoltaic panel plus Windmill

### 1.4.2. Silicon properties and photovoltaic effect:

The generation of electricity in the solar panels is thanks to the photovoltaic effect, an effect present in Silicon and other materials and caused by the reaction to solar irradiation.

We can divide materials in three categories, when we speak about electrical conductivity:

- Conductors
- Semiconductors
- Insulators

Silicon is a semiconductor, and like metals which are conductors, their electrical conductivity is based upon movable electrons. Although both of them are similar, they act completely different on aspects such as electrical conductivity.

In his crystal form it is stable, and forms a tetrahedral structure (like diamond). This union is extremely strong.

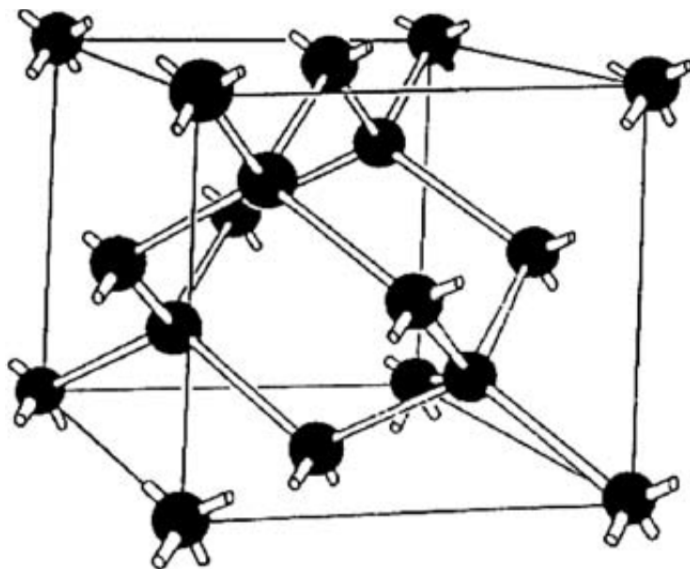

**Figure 5: Tetrahedral structure of diamond. Source:[4]**

When next to another Silicon atoms, and influence is being done between the electrons in the outer layers, some have more energy than others. But in semiconductors there is something what is called “band gap” between the conduction band and valence band.

For electricity (that means electrons cross the band gap) to occur, the bonds must be “forced” in some way. If we connect the silicon to an electrical potential, electrons can cross this gap and move from the “almost full” valence band to the “almost empty” conduction band. This effect is on the main characteristic of semiconductors.[4]

Doping is a technique used on silicon to amplify the effect previously mentioned, by adding impurities to the cristal structure we can dispose of more electrons or more “holes”<sup>10</sup>

Common doping elements added to silicon are phosphorus which give an extra electron, also other elements are arsenic and antimony. This creates a n-type conductor.

Adding on the other hand an element from the third group of the periodic table, creates more “holes”. The elements boron, aluminum, gallium, and indium are commonly used. This creates a p-type conductor.

By disposing together, the previously mentioned elements, we have in our hand the basics of a solar cell (Figure 6)

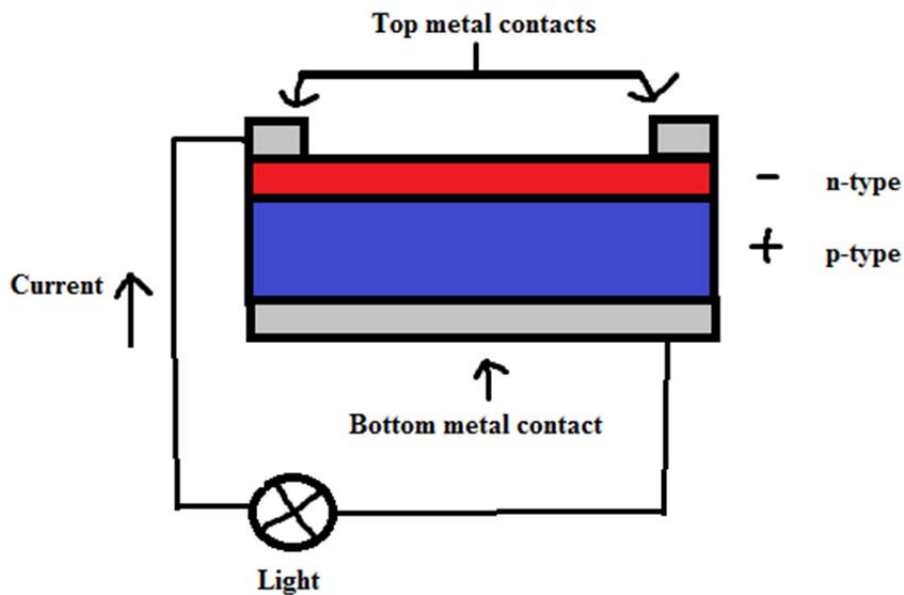

Figure 6: Basic design of a solar cell. Source: Own creation

When we put together the n and p conductors, on the union between them a depletion zone is created, due to the exchange of electrons close to the union. The part of the depletion zone close to the n type becomes positively charged and the part of the p type becomes negatively charged. This difference of polarity creates an electric field that blocks the path from the n-type electrons across the depletion zone to the p-type.

Under solar irradiation the electrons on the cell absorbs the energy from the photons coming from the sun and become free, the bond “breaks”. [5]

Due to the fact that it is not possible for the electrons to get through the depletion zone, when a cable is connected (Figure 6) the current can flow from the **n-type** (red) to the **p-type** (blue). That is the basic principle of photovoltaic solar panels.

<sup>10</sup> By holes we mean a state with no electrons

### 1.4.3. Photovoltaic cells technologies:

The most common one is the crystalline silicon. The crystals are grown using the Czochralski method. A superficial cover is also applied during the production to prevent sun's rays bouncing from the material and losing efficiency. We can mainly distinguish three main types:

- **Monocrystalline:** presents a single crystalline structure completely organized. It is obtained from pure silicon. It is the most efficient commercial technology with an efficiency around 23% by 2016.[6]. It is also the most expensive one as it is the most pure one as it is a perfectly organized crystal cell with no defects. As it is perfectly organized the cell presents homogenous color.
- **Polycrystalline:** Consists of a group of crystals of silicon but in this case it is not organized on a single macro-crystal like the monocrystalline. It is produced on a similar process to the monocrystalline cell, but, in this case the pure silicon is melted, and then is cooled down. It has a lower efficiency than the previous one but it is cheaper. Obtained from the same method as the monocrystalline but with less crystallization.
- **Amorphous silicon hydrogenated:** Disposed in a random array with a huge amount of defects and the least expensive among the three ones. It can be flexible due to the previously mentioned organization and even translucent .[7]

For the obtention of the silicon crystals **Czochralski** method is used. To grow the crystals, highly purified silicon is placed in a quartz crucible and melted. To obtain pure crystals without dislocations, a slim crystal neck of about 3 mm in diameter must be grown at a velocity of several millimeters per minute. [4]

Other type of technologies are the Thin-film technologies. These are much cheaper than the others due to the fact that they use quite less materials. The process of creation is much cheaper than the silicon crystalline.

- **Cadmium telluride (CdTe):** One type of thin-film solar cell. CdTE is a nearly ideal material for photovoltaics because it combines a serious of advantages and excellent properties, such as an excellent optical band gap and it is very easy to handle thin-film deposition processes. It has an efficiency of around 16 %. Cadmium is a rare element and toxic and not very abundant in nature categorized the number 67<sup>th</sup> in relation to its abundance.
- **Copper-indium-diselenide (CIS) and with Gallium (CIGS):** Efficiency around 19% reported in laboratory. Containing gallium that in contrast with cadmium is not toxic and its disposal is much easier than the other's mentioned later.
- **Microamorphous tandem cell (a-Si) :** Combining crystalline and amorphous technologies. This technology presents the following advantages: Potential for high efficiency, low processing temperatures (below 200°C) and reduced cost of cell

technology. The company Sanyo obtained the best results with this method, a conversion efficiency of 20.7% was achieved.

The efficiency of the cells is strictly related to how sensible they are to the wavelength from the light. Have a look at Figure 7. **Multi-junction cells** have the best efficiency among of all the types of technologies due to the overlapping of different types of materials (like a sandwich) a wider wavelength is absorbed by the cell when sun's light inflicts on the cell, reaching efficiency levels of around 46 % ( Figure 8)

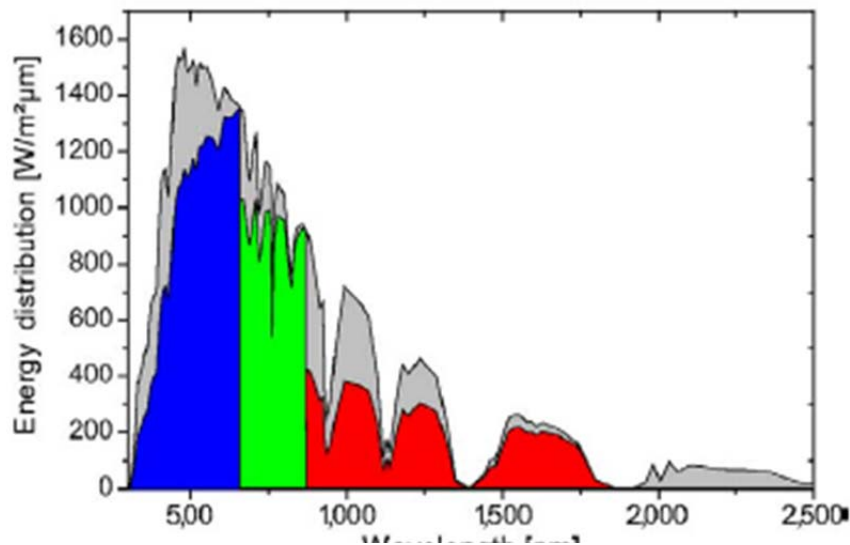

Figure 7: Wavelength absorption by cell type. Source:[4]

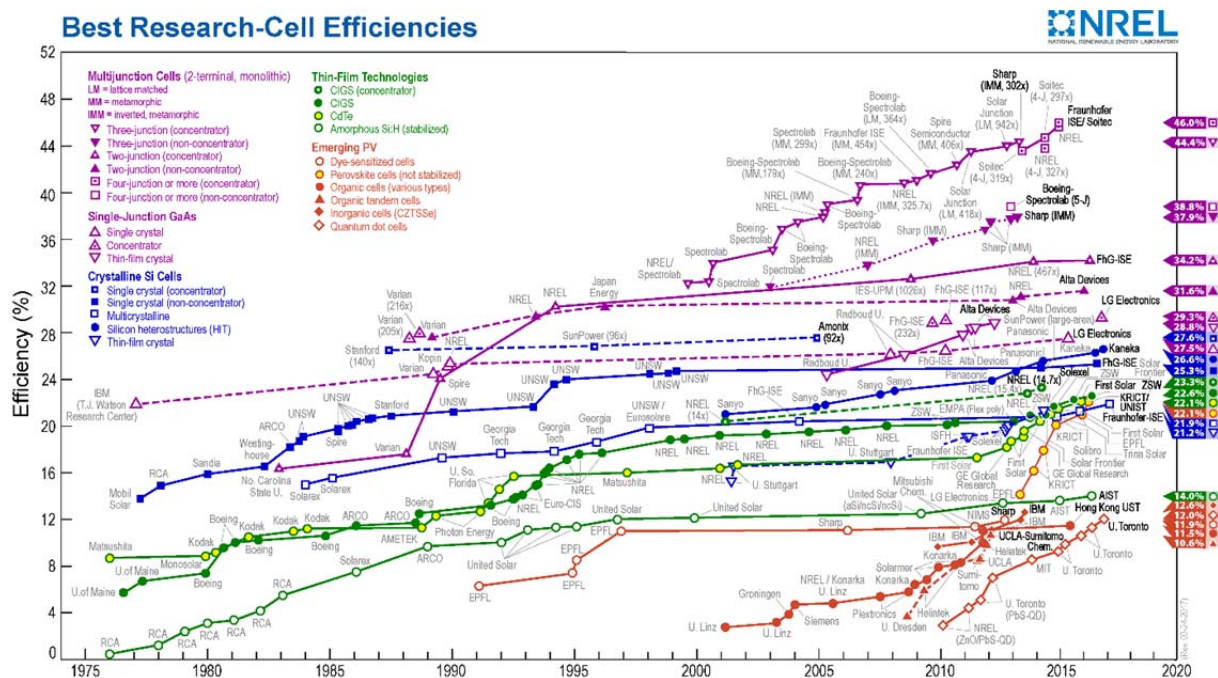

Figure 8: Efficiency chart records of the different solar cell technologies. Source: NREL

#### 1.4.4. Wind Power technologies

Normally on isolated power system supplies, when a renewable source is installed, is installed with backups systems. A small windmill is a pretty good solution for this kind of systems. The maximum possible conversion of energy from the wind is around **59,3%**, this limit is called the Betz limit.[8]

When the sun is not shining, or in winter days when the sun irradiates with less intensity, a windmill producing electricity as a support can mean a safer supply of energy throughout the year. On periods where the solar system produces enough energy, the windmill can charge the battery system or simply is not used.

This case study will see the use of a small wind turbine, difference in technology between the big wind turbines we are used to see and small wind turbines, the working principle is exactly the same.

We consider a small wind turbine, a turbine under **16 m** of diameter for the blades and under **50 Kw**. [9]

The small wind turbines can be classified in terms of the relative position of the rotating axis against the wind.

##### **Horizontal Axis Wind Turbines (HAWT):**

In this type of turbines the rotor axis is parallel to the ground. The main difference between these types of wind turbines resides mainly in the amount of blades. As the amount of blades is increased so does the area swept by the rotor, so it rotates slower which generates more torque, but it becomes worse at electricity generation.

They can be also divided in how the blades face the wind, upwind is when the “face” of the turbine is in direct opposition to the wind, and downwind is the opposite.

For electrical generation the most used one is the three-bladed in an upwind position, as it is the one which comes closer to the Betz limit.

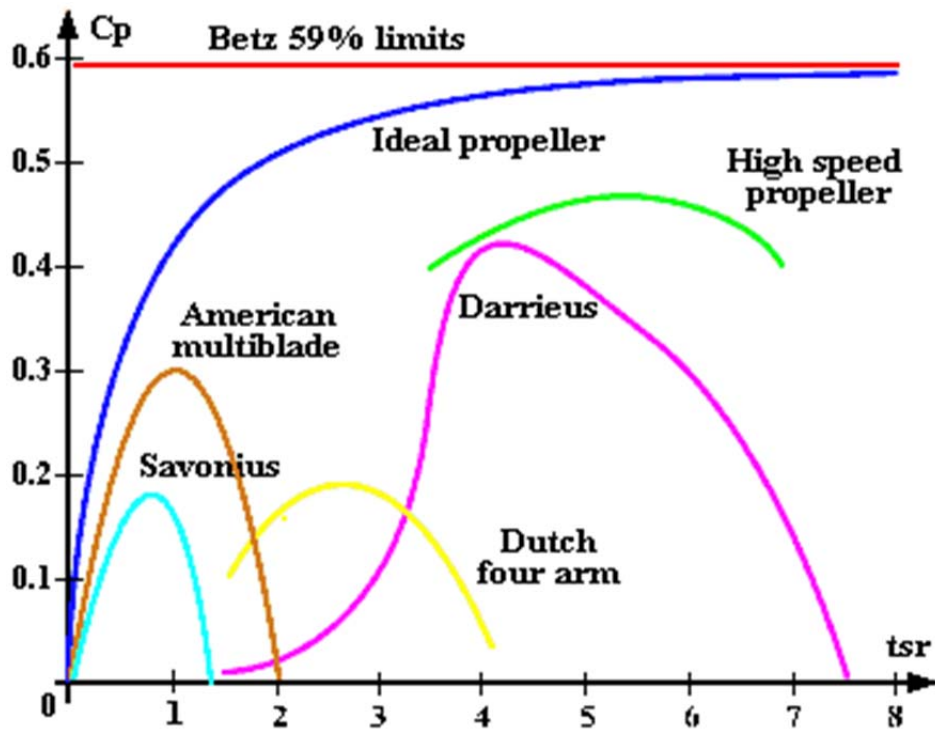

Figure 9: Betz limit and  $C_p$  parameter by turbine type. Source: Wikipedia commons

The main elements of a HAWT are the following:

- **Rotor:** Formed by the main rotating shaft and the blades
- **Generator:** The one which converts the mechanical input into electrical output.
- **Gearbox:** Normally there is a gearbox which converts the rotation into electricity better, due to the fact that generator normally works at high revolutions, even when the blades turn slowly. The ratio of change in the gearbox multiplies the rotation from the main shaft to the secondary shaft.
- **Nacelle:** It is where the gearbox and generator are installed
- **Yaw system:** It makes the rotor to follow the wind direction in order to maximize power output.
- **Control system:** Controls the general operation of all the turbines. From pitch angle to stall control. When the power output of the turbine exceeds a safety limit in pitch control, an electronic signal is generated which pitches the blades out of the wind (when the wind is too strong) reducing the angle of attack to reduce the lift. When the power is low, the opposite is done, the attack angle of the blades is changed, so it produces energy. The control is done by hydraulic control or stepped electrical motors, the latter is the predominant tendency.[10]

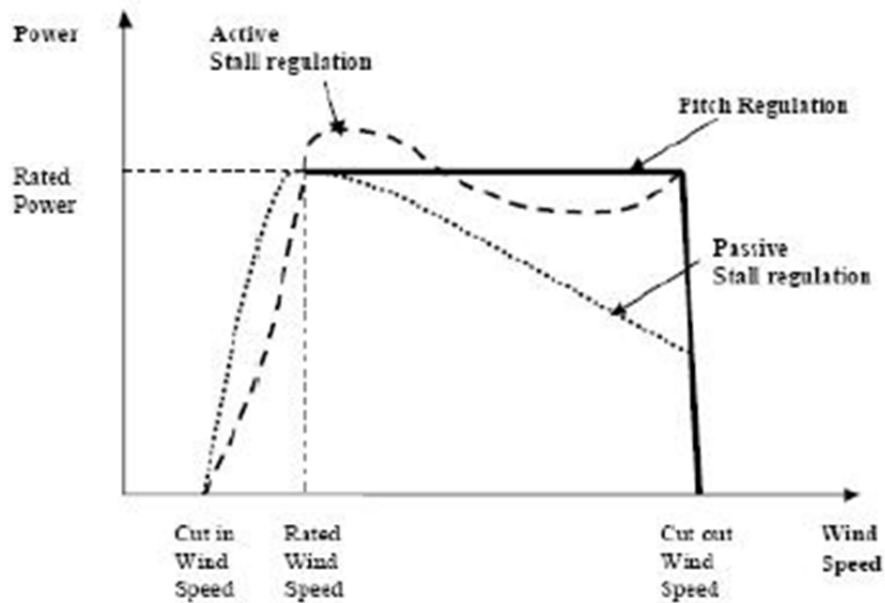

Figure 10: Passive and active stall regulation and pitch control. Source: [10]

Stall control can be done in numerous ways, from active types to passive types:

- **Passive:** They use blades attached to the hub at a fixed angle, it was designed in the case, when the wind exceeds the limit, the angle of attack to the airfoil is increased. The lift force on the blades stops stalling its rotation. The blade is slightly twisted along its longitudinal axis, to ensure that the blade stalls regularly.
- **Active:** This system resembles pitch control systems, here the blade is also pitched at low wind velocity, for the proper function, just like pitched controlled systems. The difference resides when the limit is reached, in this scenario, the stall system does the opposite of what the pitched one would do, it turns the opposite way, increasing the angle of attack, to stall the system.

Having a look at Figure 10 we can see how the different systems affect the power output. Clearly pitch control systems and active stall systems give an overall higher output, and better efficiency, the main advantage of passive stall is that when no moving parts are needed.

- **Tower:** The structure which supports the weight of all the system. The higher the turbine is located, the better, because the wind blows stronger at higher altitudes.

### Vertical Axis Wind Turbines (VAWT):

Advantages of these types of wind turbines are that they do not need to track the wind due to their axis orientation and own working principle. The structural stress is much lower in these



kinds of technologies, this allows to a simpler foundation and less maintenance of the gearbox. They deal better with turbulent wind and gusty wind, HAWT in these condition do not work well, the acceleration and deceleration generates a fatigue.

Main disadvantage is that the power coefficient is lower than the HAWT type see Figure 9. They tend to be less reliable than HAWT.

- **Marilyn:** Is a helix type, omnidirectional foil. Its geometrical construction provides a self-breaking mechanism.
- **Lenz:** Presents a “cup” design, it provides a very good efficiency at low wind speeds.
- **Darrieus:** It uses lift forces generated by the wind to rotate. Its main disadvantage is that there is an initial resistance that needs to be overpowered to start the rotation. Normally Darrieus are combined with another type of VAWT, acting as a “starter”. This saves from the need of an engine, example of a Darrieus+Savonius.
- **Savonius:** This turbine works by the difference in air pressure. One blade set comes into the wind, and the other one retreats from it. This pressure difference generates a rotation. It is used for pumping water and grinding grain in windy conditions. Savonius turbines are used whenever cost or reliability is much more important than efficiency.

#### 1.4.5. Concentration Solar Power:

Similar to the concentrators mentioned before these technologies do not make use of the photovoltaic effect to produce effect like the ones previously mentioned. Instead they focus on the Sun’s light into a point and use it to heat liquid, which is usually water, that drives a heat engine (usually a steam turbine) connected to an electrical power generator or powers a thermochemical reaction.

- **Central receiver systems (solar tower):** A solar power tower consists of an array of dual-axis tracking reflectors that concentrate sunlight on a central receiver atop of a tower; the receiver contains a fluid deposit, normally water or molten salts. The heat in the molten salt is then used to make steam to generate electricity. The molten salt retains heat efficiently, so it can be stored for days for its use[11]
- **Parabolic troughs:** Parabolic reflectors concentrates sun’s energy to a receiver positioned along the reflector's focal line. The energy heats the oil flowing through the tube and is the used to produce electrical energy
- **Dish Stirlings:** A dish Stirling or dish engine system consists of a stand-alone parabolic reflector that concentrates light onto a receiver positioned at the reflector's focal point. The reflector tracks the Sun along two axes. The receiver is heated and this heat is used for electricity production later [11]. The stirling engine attached to the system, works with thermic variation of the liquid inside the receiver .Parabolic-dish systems provide high solar-toelectric efficiency (between 31% and 32)

### Collectors:

Related to CSP<sup>11</sup>. Solar collectors are exclusively used to heat water. Their aesthetics is very similar to a photovoltaic panel, but their purpose is different. Collectors are installed on the roofs of houses (normally) and they use sunlight heat to heat water running along them. They can also be used for heating or cooling systems, heating swimming pools etc...

There are mainly two different technologies for water heating:

**Flat-plate solar collector:** The first model was developed by Hottel and Whillier in the 50's. Basically it consists of a tube running along all the area of the collector, water runs through it and the sunlight heats the tube, while heating the water in the process.

The tube is called absorber, and normally it is made of high conductive metals, like copper or aluminium, the tube is coated to maximize radiant energy absorption, and to minimize radiant emission. The module is covered by a glass, which allows the sunlight to pass, but at the same time blocks the wind from making contact with the tubes and therefore it avoids the cooling of the tube and the consequent loss in energy.

**Vacuum tube:** These kind of collector reduces convective and heat conduction losses by the use of vacuum inside the tubes. Each tube consists of two glass tubes, one outside, one inside. The outer tube is made of a strong transparent borosilicate glass, the inner one is made of borosilicate, also, but coated with a special coating, which boosts solar heat absorption and minimal heat reflection. Inside the tubes a copper pipe is placed, all tubes connected to a heat exchanger. The liquid inside the tubes is normally not "just water", it also prevents erosion and freezing.

The liquid evaporates because of the heat and goes up, to the copper manifold (heat exchanger) to a colder area, at the manifold it cools down, and transfers the heat to the pipe which carries the water that will be used for heating or other purposes.

This technology can achieve high temperatures. The actual vacuum is done between the two glass tubes, the irradiation absorbed by the inner tube is kept inside due to the great insulation achieved with the vacuum plus the properties from the inner tube's coating. Efficiency is around **93%** in total irradiation absorbed.

This kind of technology can even work in low temperatures due to the previously mentioned insulation and great efficiency, unlike flat-plate collectors.

#### 1.4.6. Systems depending their type of connection to the grid

When we implement the previously mentioned technologies on a house, a hostel etc... any consumer now is producing its own energy. When producing your own energy you change

---

<sup>11</sup> CSP stands for concentrated solar power

from a central distribution type to a distributed generation type, meaning now the generations points are not focalised.

Not getting into the details, this distributed generation is seen by many as the future of distribution networks.[12] Because it would not only improve the energy independence of poorer areas, but also improve the losses during transportation (due to the fact that the source of energy is located closer to the demand). In Europe such losses represent around the **15-20%** (See Figure 7 )

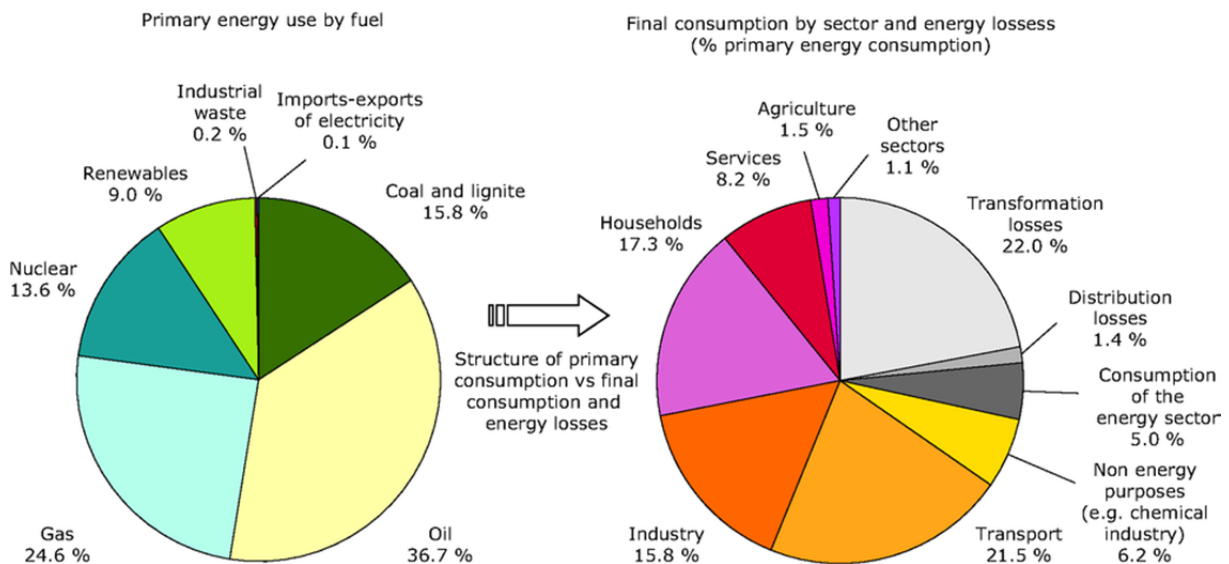

**Figure 11: Primary energy use vs Final consumption. Source: [13]**

As we briefly mentioned before in the introduction to this chapter, self-generation renewable installations are found normally in two possible forms:

- **Connected to the grid:** In this case there is a generation of energy, but the producer is connected to the network, this could be the case for example of a city building with roof installed solar panels. This kind of installation has the benefit that in case of excess energy, it can be injected into the network and in times of need, the electrical supply can come from the grid, eliminating the need for ES<sup>12</sup>.
- **Off-grid:** This is the case of the objective in this case study. Off-grid installations are completely isolated from the conventional grid. Because there is no backup possibility from a grid to supply the needs, we need a way to store the energy produced during the day plus the one produced by the windmill, to be able to use it, when it is needed. Also a cogeneration system (diesel engine for example) is normally recommended for auxiliary use.

<sup>12</sup> ES: Energy Storage

Places like small villages could develop this configuration to the next level, by the creation of a micro-grid, where all the different generation points could be interconnected, and supply the needs to all the loads without being connected to the conventional grid.

### 1.4.7. Energy store systems:

Energy store systems (also called batteries, accumulators) are what make an off-grid system viable. It permits the storage of energy for later use when it is said that energy is needed. There are quite a lot of technologies (see Figure 8) available, although not all of them are suitable for the kind of project we are dealing in this case study with.

They are one of the most expensive parts of the installation, that is one of the main reasons off-grid installation need much more thoughts about their dimensioning due to the fact that they cannot store the excess energy anywhere when accumulators are full.

They can be divided also into primary and secondary energy store systems. This means primary batteries cannot be charged again when discharged, but the secondary ones can be. In this case study we will focus on secondary types.

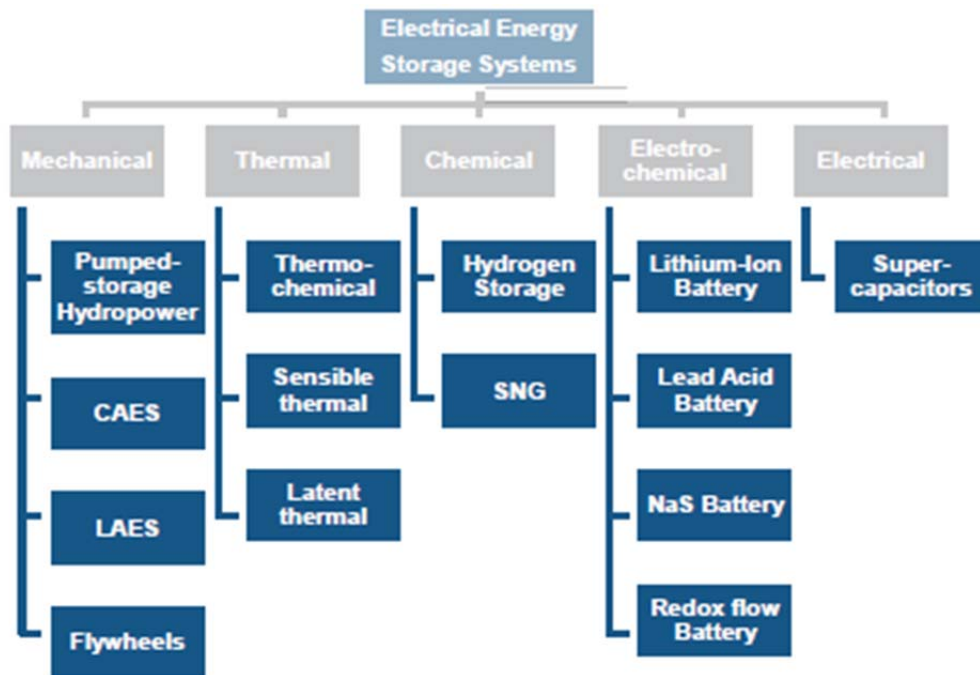

**Figure 12: Overview of the different ES technologies. Source: Pwc 2015**

The most used energy storage systems on photovoltaic systems are lead-acid battery and electro-chemical energy storage, due to their easy availability, it is a mature energy store technology and these kinds of systems are the ones which give the best LCOE<sup>13</sup> together with Li-ion batteries [14]

<sup>13</sup> Levelised cost of energy

#### 1.4.7.1. Lead-Acid:

They are composed of plates of lead inside an electrolyte, for example sulfuric acid. When the battery is charged and a charge is connected to it, a reaction occurs between the lead plates and the acid, this makes the electrons to flow and feed the charge. The chemical reaction that occurs is two sided and can be reversed (charging the battery). Their basic principle does not change along the different types of lead acid batteries but it does the configuration, they can be classified in three main categories: Monobloc, stationary transparent/translucent and airtight.

**Monobloc:** As their own name indicates, they are disposed in an individual block, that means that there is no need to interconnect the individual cells to obtain 12,24 or 48 V. They have less capacity than airtight or translucent ones. They are mainly used on installations of low power requirement.

**Stationary translucent:** What are separated into cells, and the material they are covered with allows to see the level of the electrolyte inside of them. Because they are cell type batteries their voltage is 2,2 V, that is why they are connected in series to obtain the desired voltage. These types of batteries are bigger than monobloc ones and heavier, so in order to make easier the installation process they are installed without electrolyte and then filled.

**Airtight:** They are locked, so there is no access to their interior. They require minimum or no maintenance at all. They can be internally filled with a gel, this makes the electrolyte denser, so the electrolyte stays in place, which makes to install them in any position. The electrolyte does not need maintenance as mentioned before, but it does not support deep discharges very well. [7]

Lead batteries are cheap but their components are extremely dangerous for the environment and after their life expectancy, they are difficult to process. So in places like the European Union, they are fomenting the research on other alternatives which are easier on the environment.

#### 1.4.7.2. Li-ion battery:

They are composed of a graphite electrode and a Lithium one. Their electrolyte is composed by a lithium salt dissolved in an organic compound. They are being heavily investigated right now, and almost every year new advances in this kind of battery are discovered, like a recent discovery from the Massachusetts Institute of Technology (MIT) were they claim they double the capacity density of Li-ion batteries [15]

Their actual popularity is not by chance, they are heavily used in all kinds of electronics, especially smartphones which is one of the reasons that this kind of storage is evolving so quickly. Right now its popularity for the chosen ES<sup>14</sup> for isolated photovoltaic systems is growing.

---

<sup>14</sup> Energy Store

Their advantages are:

- High efficiency at charging and discharging
- No memory effect
- High capacity/volume and high capacity/mass. This one is the most attractive perspective from this tec.
- Low self-discharge rate

Their main problems are:

- Higher cost than Lead acid batteries. Although every year is slowly catching up.
- Limited number of cycles.

### **1.4.7.3. Other types of electro-chemical batteries:**

#### **Ni-Cad:**

Similar previous technologies they have three parts: a cathode of nickel hydroxide and an anode made of cadmium, both of them inside with an electrolyte.

Very similar to lead acid batteries in term of characteristics, too. Their capacity is low-average. As being a well matured-developed technology, they are quite trustworthy for energy supply in the kind of scenarios of renewable generation systems etc...

Their main advantage is that they are kind of a superior version of lead acid batteries, although it is more expensive (price is strictly related to the use of cadmium, as this material is quite rare) than the latter mentioned, they have superior capacity compared to lead acid batteries and high number of cycles before replacement.

The big inconvenience in this battery type is the memory effect, which reduces the total capacity use of the battery and the material cadmium, which is extremely dangerous for the environment.

#### **Ni-metal hydride:**

Like Ni-Cad battery, but the cadmium is replaced with a metal hydride, which is less toxic than cadmium

Inconveniences:

- High auto-discharge
- Memory effect

#### **NaS:**

Composed of sodium and sulfur. The temperature at which they work is around 200 C°, this implies the need for proper security measures when using this kind of battery.

The use for PV installations in building, houses etc... is not used due to security reasons. Especially in places like the one this case study focuses on, where the risk of fire is very high.

Their efficiency is high for charge and discharge: 89-92% and long cycle life.

**Redox flow batteries:**

Two electrolytes react to produce the electrochemical reaction for storing and releasing energy. The contact between them is made possible through a microporous membrane that does not allow both electrolytes to mix.

Having both electrolytes separated, avoids the so called self-discharge effect, so possibly this kind of battery could be perfect (future) for the type of installation we are dealing with in this case study. But right now they still have a high price mainly due to the cost of the electrolyte.

Even some models of this technology are commercial right now, it is a pretty new technology, so in a medium-short term improvements are to be expected. Some models of this battery type are even in direct competition with Li-ion batteries.[16]

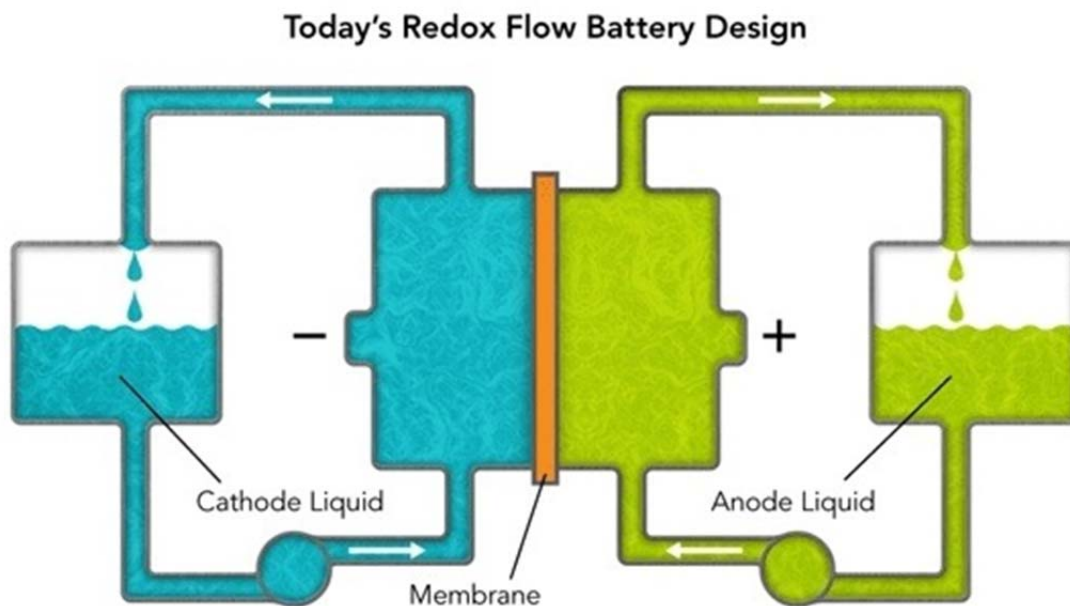

**Figure 13: Redox battery simplistic view**

Now let's have a look at other types of energy systems. The ones we have already seen are the ones we will consider in this case study, mainly **lead acid** and **Li-ion** because they are easier to obtain and implement, they are cheaper, and they are more convenient for the client in the end. The next few technologies, although could be used for a PV system, their implementation falls of the reach of this case study.

#### 1.4.7.4. Mechanical energy store systems:

These kinds of systems go from the oldest type of energy store know (Pumped-Hydro-Energy Storage) to other more modern technologies such as FESS (Flywheel Energy storage)

##### **PHS<sup>15</sup>:**

They are by far the most matured and developed ES technology. Analysis of energy storage projects compiled by the US Department of Energy shows that pumped hydropower storage capacity in operation worldwide forms over 97% of the total storage capacity in operation[14]

PHS works by storing water on a higher height, by doing this the water on the upper level has a potential energy that can be used by simply making it fall to a lower level and through a turbine to produce electricity.

A small scale variant of PHS could be implemented, as we said, into a PV+ wind plant, but this implementation is out of the reach of this project.

Advantages:

- Mature technology
- It can store an enormous amount of energy with a lot of power output
- Quick response

Disadvantages:

- Huge initial investment cost
- Need of a good geographical place

##### **Compressed Air Energy Storage (CAES):**

Together with PHS are the most matured, and other technologies bring a cost and risk premium due to their lower levels of commercial maturity.[14]

It works by storing compressed air with the low cost off-peak energy in an underground deposit and releasing it, when needed, with a mix of fuel for later combustion in a turbine.

The main inconvenience when implementing this technology is the selection of a reservoir, it can be a natural cave of some sort but not always the case.

Pros:

- Quick response
- Long cycle life
- Low LCOE

---

<sup>15</sup> Pumped hydro energy storage



Cons:

- Huge initial cost
- All the system depends on finding a good emplacement

### **Flywheel Energy Storage Systems (FESS):**

It uses inertia as the gimmick for energy storing. A rotating wheel that can be accelerated to a very high speed (around 100000 rpm), transforms the input electrical energy into kinetic stored energy in the rotating low –friction flywheel.

Examples of this technology can be found at CERN (European Organization for Nuclear Research) where they use this technology to compensate spikes in demand from the particle accelerator. They are used because of their quick reaction response.

#### **1.4.7.5. Electromagnetic:**

There are two commercial types of electro-magnetical energy store systems:

**SMES:** The functioning is very simple, it consists of coil, made of Niobium-Titanium, is cooled to very low levels of heat with liquid helium, to reach a temperature below its superconducting critical temperature, the power conditioning system and the systems which cools the coil itself. Once the coil reaches the superconducting state, it can be charged and the current will circle around till it is used.

Advantages of this system are:

- Almost instant response
- Possibility to discharge them completely at high power output
- High efficiency around 95 % and long life

Disadvantages:

- Refrigeration system is very expensive and a very high energy output is needed for maintaining the temperature.
- Still a very immature technology

**Supercapacitor:** It is basically a very high capacity capacitor that is connected in series-parallel, similar to the display of plates in a battery, to achieve higher voltages.

Advantages:

- Response time almost instant
- Very long life

Disadvantages:

- Very high cost for big applications
- Very low energy capacity storage
- Low capacity/volume so they tend to be much bulkier than conventional ES systems

#### 1.4.8. Elements of a typical isolated PV generation system

Once we installed a photovoltaic solar system, our panels will start generating electricity, if we connect our panels with the batteries and the loads to feed in parallel, the following problem will occur:

- The voltage given by the PV system can be too low or too high putting in the danger the battery
- The solar PV systems give energy in the form of DC (direct current) so for a few loads that work with DC, nowadays almost all consumptions in a house are in AC.
- During the day the battery would be charged by the panels, but because of the fact that there is not any control for the charge process, when it is full, the energy will be still forced inside the battery. This is not only dangerous, but will also destroy the battery in the long run.
- Not adjusting voltage from the panels to make use of the maximum power possible for the panel, under the changing irradiance levels and adjusting to the different changes along the day with a MPPT (Maximum power point tracker) device. Lost efficiency.

So a bunch of balance of system elements will be needed for the optimal and correct use of the duo **PV+Wind** with the ES system. A charge controller (also called regulator or battery regulator) for the best use of the battery, and an inverter to convert the energy from DC to AC.

But first let's take a look at how solar panels behave under different circumstances and the different configurations. This will be relevant later when we speak about the inverter and the charge regulator.

The behavior of a solar panel is measured under certain standard conditions[7]:

- Solar irradiance:  $1000 \frac{W}{m^2}$
- Temperature: 25 °C
- Angle of the sunlight perpendicular to the module
- Air mass: 1,5 AM

The I-V graphic of a solar module presents this form under these circumstances

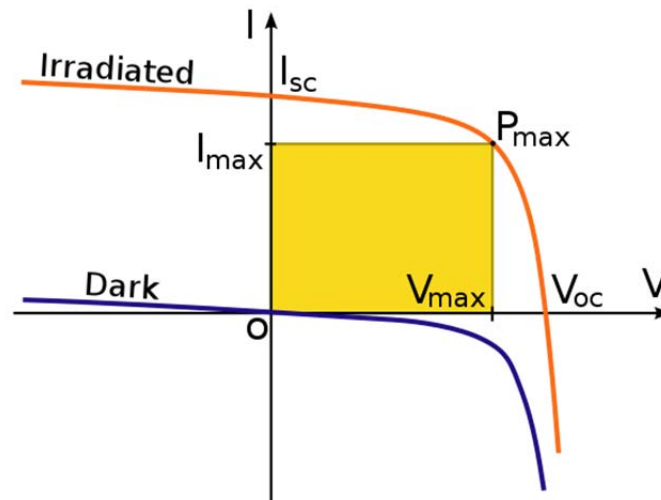

**Figure 14: Solar cell V-I graphic. Source: Wikipedia Commons by original author: S-kei , svg version by Actam**

We can distinguish from Figure 9 that there is a point of maximum power output from the solar cell, this operation point is what we aim for because this is the point of maximum usage and power output of the cell.

$V_{oc}$  is the open circuit voltage together with  $I_{sc}$ , which is the short-circuit current, both parameters are relevant on the designing phase for making sure that on the worst scenario the other elements such as: inverter, regulator etc.... can work safely and do not break.

PVs are also connected in parallel and in series to achieve the desired current or voltage. The next Figure shows how the V-I graphic changes under the different configurations. Connecting them in a parallel array the current augments in direct relation to the amounts of panels connected. For a series connection the same thing happens, but in this case the voltage multiplies.

#### 1.4.8.1. Inverter

This electronic component is the one responsible for converting the DC output of PV or a storage battery to AC electricity, either to be fed into the grid or to supply a stand-alone system.

Some design criteria and functionality of PV inverters are:

- efficiency: well above 90%
- voltage and current quality: harmonics and EMC,
- overload capability: some 20-30% for grid-connected inverters, up to 200%

- for short-time overload of island inverters,
- precise and robust MPP tracking (reliably finding the overall MPP in partial shading situations),
- supervision of the grid, safety/ENS2,
- data acquisition and monitoring[4]

There are different types of inverters, depending on how they convert the wave from DC to AC. Some are grid-tie inverters, these types need a “wave example” from the electrical grid to convert the DC current to a sine wave and injecting it. They are normally used in general local electrical power generators.

The type of inverters can be classified by how they convert the wave:

- **Square wave inverters:** Normally used for isolated installations. They have low efficiency, also the shape of the wave creates a lot of harmonics, which cause sound disturbance. They are the cheapest type of inverters.
- **Sine wave inverters:** Used for grid connection PV systems. High efficiency and minimum THD<sup>16</sup>. Expensive in comparison with the other three.
- **Modified sine wave:** A mix between the other two. It is the sum of two square waves which is phase shifted 90 degrees relative to the other. The final wave resembles a sine wave.

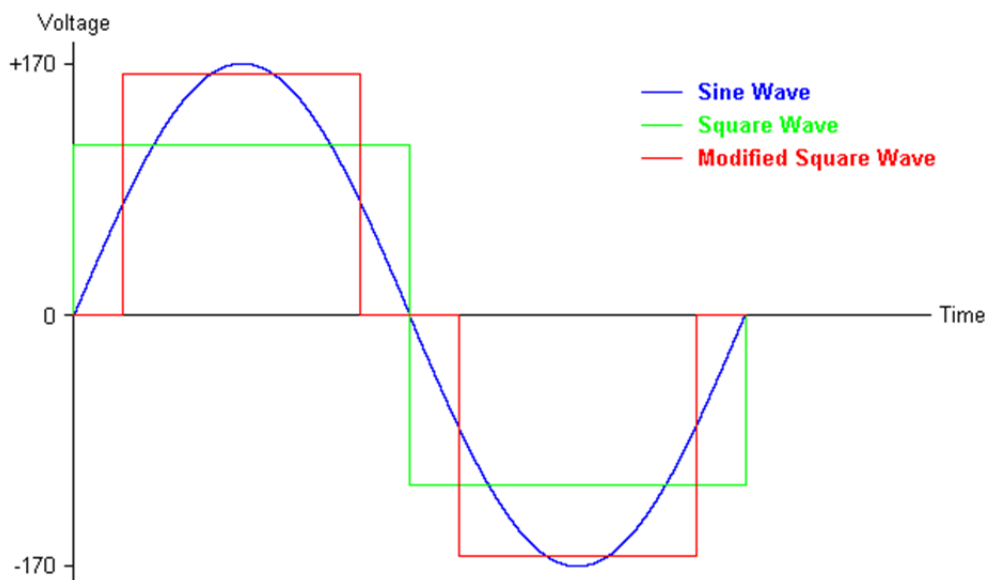
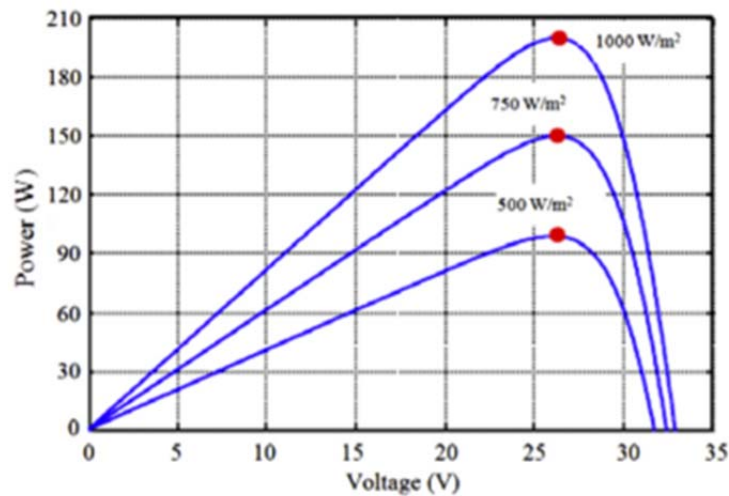

**Figure 15: Different types of waves.**

Not all electronics, power consuming elements are compatible with square or modified sine wave inverters.

<sup>16</sup> THD: Total Harmonics Distortion

With the changes in irradiation and temperature along the day, the working point of the solar panels changes, too. This change of irradiation implies a change of the point of maximum power from the solar panel. [17]



**Figure 16: PV power output for different irradiation levels.**

As we see in the upper figure the power output of the PV panel changes quite significantly for the different irradiation levels. The PV already has a low conversion efficiency in the range of the 9-15% normally, so the need to maximize as much as possible the energy we take from it, is crucial, by MPPT methods, Tracking systems etc...

Inverters are commonly build with a MPPT (maximum power point tracker). The method for finding this working point are different, can be divided into:

**Indirect:**

- Fixed voltage method:** This technique is based on adjusting the PV system on seasonal basis. One Pmpp for winter and other one for summer for the same level of irradiance. In winter due to lower temperatures it is expected that the panel has a better performance than in summer.  
This method is very easy to implement, but as we can see the disadvantages, because of the inaccuracy of this method. Although in winter performance improves due to lower temperature, in summer also the irradiation level and hours of peak sun are much higher than in winter. Also does not take into account changes along the day etc...
- Fractional open circuit voltage method:** The near linear relationship between VMPP and Voc of the PV array, under varying irradiance and temperature levels, has given rise to the fractional Voc method.

$$V_{mpp} \approx k * V_{oc} \quad (1)$$

The factor  $k$  is a constant calculated empirically, it depends on the array of the PV and irradiance/temperature. The procedure basically consists of opening the PV circuit and measuring the  $V_{oc}$  (Figure 14) then once measured, applying the equation we obtained the  $V_{mpp}$  for that working point. The problem of this method is that there is a power loss due to that circuit is opened.[17]

**Direct:** These methods make use of processors to read and compare the results in real time. They are much more accurate than the previous ones.

- **Perturb and observe method :** This method consists of perturbing the PV array's terminal voltage periodically, and then it compares the PV output power with that of the previous cycle of perturbation[17]

Once it has done the perturbation measures the power and compares it to the previous measured power. If power has increased but for example the voltage does not, then it will add a bigger perturbation for the next cycle. See Figure 17



Figure 17: Perturb and observe algorithm. Source: [17]

- **Incremental conduction method:** This algorithm is derived by differentiating the PV array power with respect to voltage and setting the result to zero.

$$\frac{dP}{dV} = \frac{D(V \cdot I)}{dV} = I + V * \frac{dI}{dV} = 0 \text{ at the MPP} \quad (2)$$

Organizing the equation we obtain.

$$-\frac{I}{V} = \frac{dI}{dV} \quad (3)$$

The inverter will proceed and compare the result following its internal algorithm. It works measuring the instantaneous V and I of the panel, and it compares it with a value of reference from a previous working point. By following a simple logic structure, it compares the values and depending the result amplifies or reduces the voltage. If everything is the same, the new measured values are the new reference values.

These are some examples of MPPT methods, but there are much more methods and variations of the ones exposed. The investigation and advances for this kind of methods are still being made.

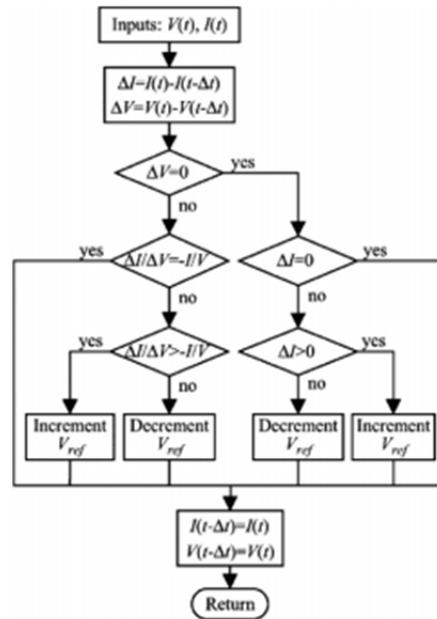

**Figure 18: Algorithm for incremental conduction method. Source:[17]**

The inverter can be installed in different kind of ways, what brings advantages or disadvantages, depending on how many modules it collects. Usual installation array:

- **Central:** All PVs are connected to one central inverter. This configuration requires a big inverter. The bigger the inverter the better efficiency we get. Also having only one inverter lowers the overall price, bigger inverters have a lower LCOE too, inverters from 10 to 100 Kw having a LCOE of **10 cents of €/W**, in comparison a 5 Kw having **22,8 cents/W** (German market data) [15].

The disadvantage of central inverters is that the MPPT controls all PV panels as one, meaning that panels which are receiving more or less solar energy due to different reasons, they are not making use of their maximum possible power output.

- **String:** Normally PV panels are connected first in series a bunch of them to achieve a desired voltage. These strings are connected to an inverter in this configuration type. The range of power are from 0,5 to 3 kw.

This configuration is used when within the same installation are panels which orientation/ inclination are different or shadows that cannot be avoided. This is due to the previously mentioned, in central inverter areas where panels may have different working points are not regulated, this configuration pretends to plan earlier which possible panels could have a different working point and try to make all panels work at MPP.

- **Individual:** Every solar panel is connected to a micro inverter. This configuration tries to make all panels work at MPP. The inverter is pretty small, so it can be within the panel's configuration panel itself.

The main inconvenience of this configuration is, that the cost of installing all those inverters is pretty high, but also more output is taken from the panels thus more Kwh are produced due to all of them working at MPP.

Also maintenance is more difficult due to the more amounts of inverters, that due to statistics, the more there are, it is more likely to break.

#### 1.4.8.2. Regulator

This electronic device is used to manage and protect from overcharge and from very deep discharges of the battery system. Normally it is installed in isolated installations, because this kind of installation requires a battery system, in order to control the charge of the battery system.

There are two types of regulators:

- **Series regulator:** It cuts the current to the battery before it overcharges, it means when the battery has reached its maximum.
- **Shunt regulator:** This regulator dissipates power, to eliminate the excess of energy produce. It consists of a transistor in parallel with the photovoltaic panel.

Furthermore depending on the voltage input they allow:

- **PWM regulator:** It is in essence a switch that connects a solar array to the battery. The result is that the voltage of the array will have to be the one of the battery system.
- **MPPT regulators:** This regulator makes to use the previously mentioned MPPT power control for the arrays of solar panels, therefore they harvest the maximum energy possible from them. They also tolerated voltage inputs higher to the one used in the battery system, what allows to connect more panels in series to the regulator.



### 1.4.9. Protection elements in a PV system

Let's speak about shading before entering into the typical protection elements of a PV. Shading occurs when something (there are clouds, tree's branch, snow etc..) blocks a cell from a solar panel or an entire module.

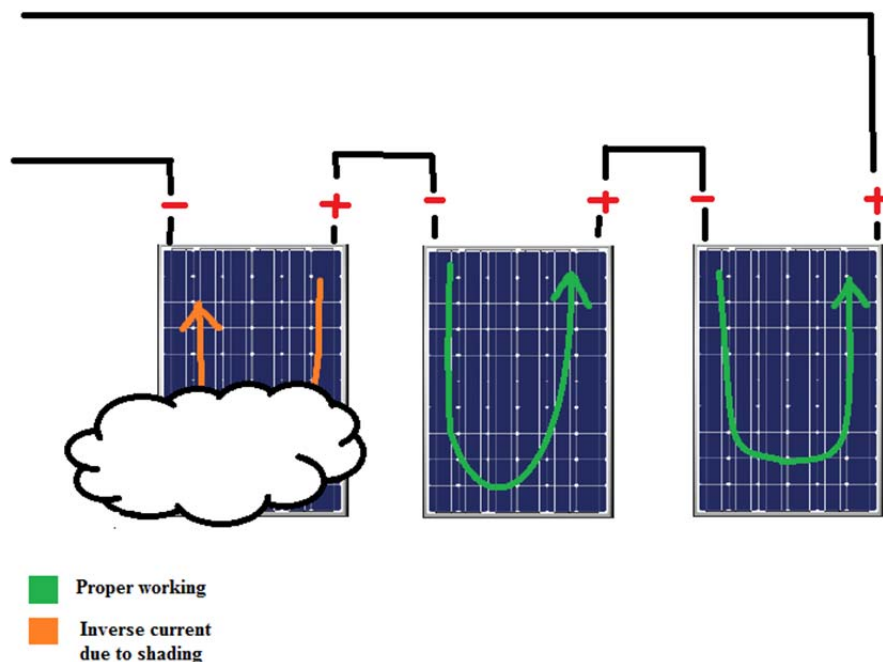

**Figure 19: Shading effects. Source: Own creation**

In Figure 19 we can see a simplified version of what can happen. An object blocks a cell or a bunch of them, it causes a reduction of the total irradiation on the affected cells, lowering their voltage output.

The rest of the module's cells are working on normal conditions, so their functioning is unaffected by the blocking object. This difference in voltage in cells of the same module can cause that the current instead of following the usual path, it goes backwards. This supposes a reduction not only in production, but now the panel is consuming electricity instead of producing it, what raises the temperature inside the cells, what puts in danger the cells.

To prevent this kind of situation and protect the panels, diodes are installed on the following way:

- **By-pass diode:** Located inside the junction boxes in the panels. Connected in parallel with series of cells of the solar panel and series of panels. Normally around one by-pass diode per 20-14 cells.

In case of the solar panel due to shading, when connected in series with others see Figure 19, the by-pass diode opens and is the easier path for electricity disconnects the panels from the series.

Normally a group of by-pass diodes are installed in every solar panel, making able to “jump” series of cells which work in reverse.

- **Blocking diode:** They do a similar job to by-pass, but in this case they protect strings of panels from other panels when they are in parallel. Let’s see an example for the better understanding.

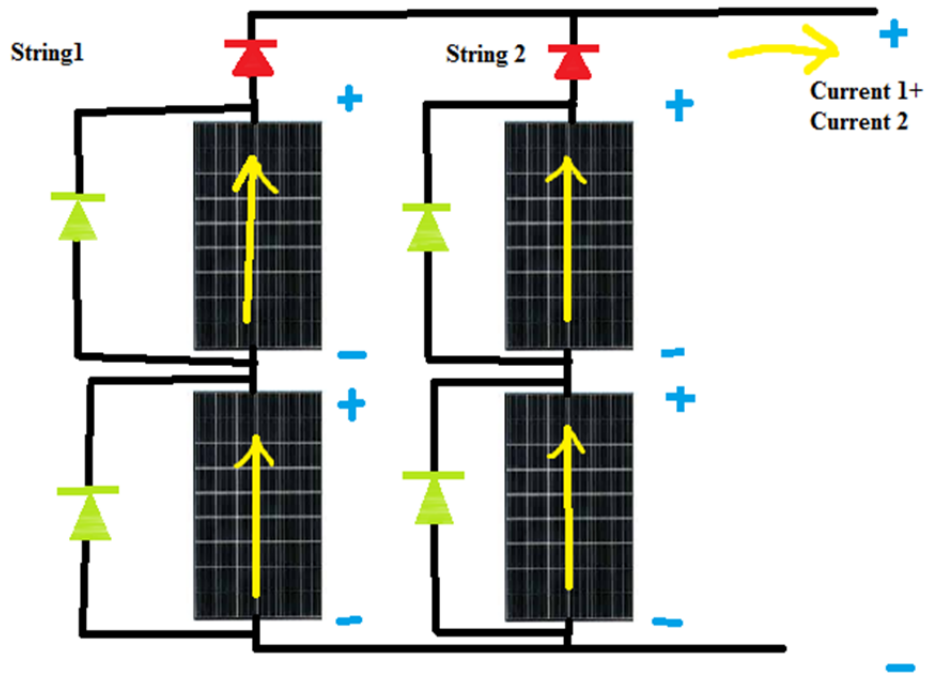

**Figure 20: Diodes disposition in solar panels. Source: Own creation**

Looking at Figure 20 we can see, that under normal circumstances the current (Yellow) will flow as it is displayed. Shadowing as we saw previously, that panels in one string start to go on reverse, the by-pass diode (Green) will open and “cuts” the malfunctioning panel.

In the scenario that a string of panels were at a lower voltage than another string, could cause also that the panels with higher voltage “tried” to feed the lower voltage panels string. This is solved by a blocking diode (Red), in this case the diode will block all currents coming from other strings to the string is located.

All these diodes consume some voltage, causing a loss, so the voltage and the sizing should take in mind these losses. When a diode is active, some power output potential is lost but this loss is preferable to the possible damage to the panel.

#### 1.4.9.1. Elements of protection for the line and systems

A very basic overview on the other elements to install are there in order to protect the line from short-circuit and overcurrent.

- **Circuit breakers:**

These elements protect from overcurrent and short-circuit. They have two mechanisms for opening the circuit, one thermic and another magnetic.

The magnetic circuit is composed of an electromagnet and it protects against short-circuits. When a defined multiply of current (established by the manufacturer) is achieved, the magnetic circuit opens.

Second, the thermic device protects against overcurrent by a bimetallic sheet, which is heated, as they are different metals, it deforms when a certain current passes through it for a certain amount of time, opening the circuit.

- **Fuses:**

Dispositive that opens the circuit when a certain current is exceed. They are composed of an outside insulator (made of ceramic, plastic or glass) with the conductive material inside. When the current overpasses the established limit, the conductor burns inside, and opens the circuit.

Once fused, the fuse must be replaced. They are located between the photovoltaic panels and the regulator, between the regulator and batteries and between the batteries and the inverter.

These two elements are normally combined to save money and better protection of the installation. When an installation exceeds 48 V, it will also need a grounding plus a differential to secure against indirect contacts[7]

Although the solar panels will need some kind of grounding when they exceed the 48 V limit. The masses of the solar panels, regulator and other elements should be connected to a grounding.

Protections inside the house itself enter in the category of low voltage and normally has its own legislation. This project will not define those protections as it falls out of reach.

### 1.5. Design alternatives to be considered

We can define a series of alternatives to solve the farm’s energy needs. As we mentioned earlier the energy needs are mostly electrical, but there is also a small energy requirement of heat energy in winter (heating system).

Then the difference between the different alternatives will be on how we distribute the hybrid system, by distribution of the hybrid system is meant the importance we will give to the wind turbine on the energy production aspect.

As we defined previously on the criteria for the installation sizing, a hierarchy is established:

1. Proper solution to his problem
2. More energy supply security and reliability
3. Economical
4. Environment
5. Subjective aspects like: Aesthetics, personal preference from the client etc....
6. Others

So all alternatives will provide a solution to the farm problem (energy demand) but gives a higher share to the wind turbine on the electricity production aspect, which can mean more energy security and reliability.

The number of cloudy days in Neamt County along the year is pretty high, which affects the solar panels production.

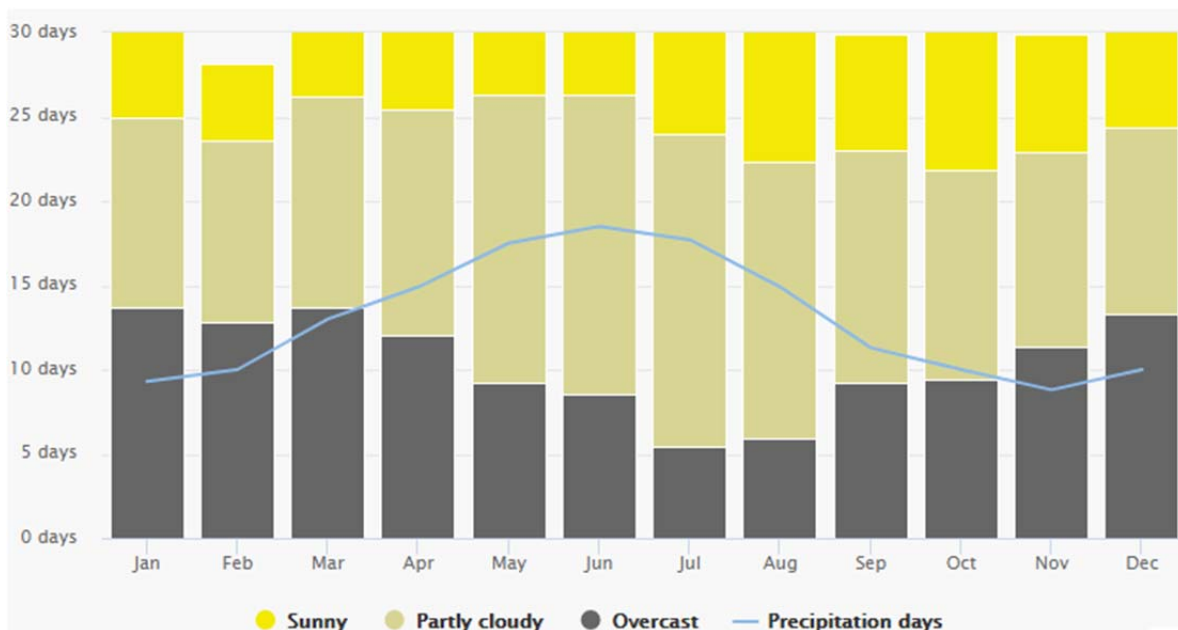
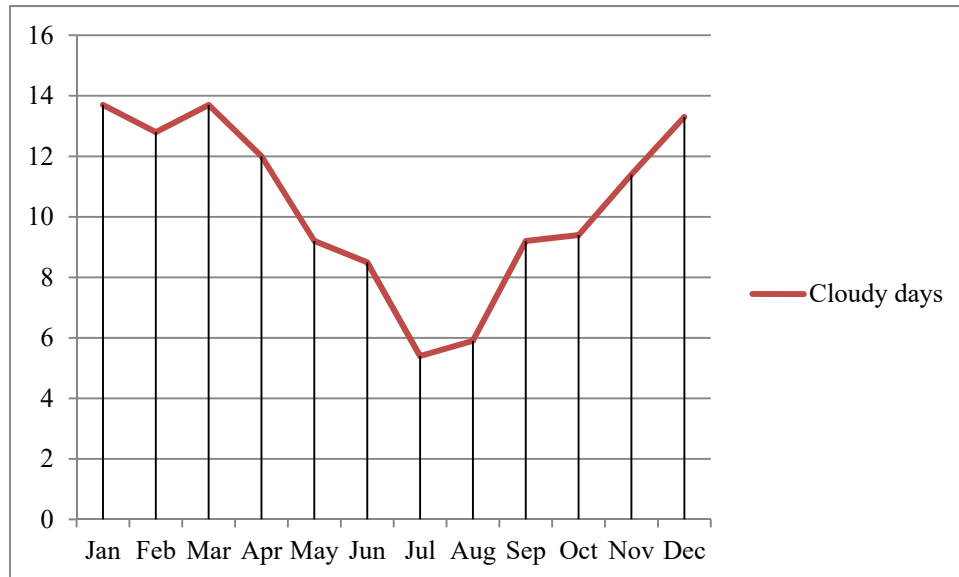

Figure 21: Forecast for Neamt county. Source: Meteoblue

Watching Figure 21 we can see the forecast per month , In Figure 22 can be seen that the amount of cloudy days are pretty high, the amount of cloudy days is also higher in the critical months (those with the least solar irradiation) which is almost 50% of the days in the month of January. These cloudy days affect solar panels production, reducing it or almost making them to no produce at all.



**Figure 22: Cloudy days by month. Source: Own creation**

The wind turbine gives more energy production security, as not only trust we energy production to an individual source (photovoltaic), although solar panel production will be the main production source.

Design alternatives:

- All solar panels
- Solar panels+ Small wind turbine 750 W
- Solar panels + Small wind turbine 3000 W
- Solar panels + Small wind turbine 6000 W
- Collectors+ Solar panels

The design alternatives will now be compared to the different design alternatives. The criteria previously mentioned (see Page 8) will be used to select among the possible alternatives.

Checking the Calculations chapter, it is needed to entirely understand aspects such as: Power demands, selection between elements....

### 1. All solar panels:

The very first solution and the most direct is to supply the installation solely by solar panels.

This could be achieved by the installation of 59 solar panels **TM-M672340** of 340 W from the company **Tamesol**. This method involves the least inversion (see Table 1) in comparison with the other design alternatives, due to the fact that the installation of solar panels itself is the cheapest solution, but the problem with this design is that it does not secure a continuous supply of energy around the year for the reasons we have seen before.

The forecast is not very favourable to a solar solution only, so some kind of backup from a wind turbine will be needed for securing a constant production following the criteria.

### 2. Solar panels + Small wind turbine 750 W:

Another possible solution could be the installation of solar panels plus the addition of a small wind turbine of 750 W, model **LE-600** from the British company **Leading Edge**.

The addition of this turbine will change the number of panels needed from 58 to 59, so the actual difference almost disappears. The inversion on the other hand is higher in comparison to solely solar panels solution, in addition, plus 1124.39 € is needed. The inversion includes the price of the turbine plus the regulator that is sold apart.

The small wind turbine helps charging the battery system, helps in critical months, when the days are shorter and there are more cloudy days.

### 3. Solar panels + Small wind turbine 3000 W:

The third design alternative is the installation of a wind turbine of 3000 W model **E-30 PRO 48 V** from the company **Enair**, plus the solar panels previously mentioned.

As it is a bigger turbine, the amount of panels needed to install changes from 59 to 52, and an inversion of **4975.76 €** more in comparison to the first option.

This solution gives much safety and security for energy supply during the critical months.

### 4. Solar panels + Small wind turbine 6000 W:

If installing an even bigger turbine, the proposed model **Bornay 6000 W (48 V)** would be from the company **Bornay** in this case.

With this solution we give a much bigger share to the wind energy production. The amount of panels to install is **43**, and an additional inversion of **6911,80 €**.

	Power demand (Wh)	Panels Needed	Panel Power (W)	Difference amount of panels (%)	Wind turbine cost (€)	Regulator cost (€)	Money Inversion (€)
<b>No turbine</b>	38088,18863	59	340	0	0,00 €	No needed	0,00 €
<b>750 W Turbine</b>	37160,60577	58	340	1,694915254	987,09 €	266,50 €	1.124,39 €
<b>3000 W Turbine</b>	33401,38221	52	340	11,86440678	5.880,16 €	Included with turbine	4.975,76 €
<b>6000W Turbine</b>	27524,85101	43	340	27,11864407	8.979 €	Included with turbine	6.911,80 €

**Table 1: Comparison of the different designs.**

The following additional design option will be mentioned, although it will not be considered in the installation as its design falls out of this project reach:

### 5. Collectors + Solar panels:

The industrial boiler consumes the most energy out of all devices (see Power needs of the installation), which could be fed by a series of collectors (vacuum or simple ones) connected in series and parallel.

Since collectors have much higher efficiency at converting energy from the sun to heat energy than solar panels, this application could be interesting.

In addition, solar panels feed the rest of the consumptions in the house and the industrial fridge. But as mentioned before this design is only mentioned as a possible solution, but it will be not extended or considered as a solution, as it was previously stated.

### 1.6. Description of the final solution.

Before exposing the proposed solution, let's compare and select the best design solution.

#### 1.6.1. Comparison and selection of the best design

All the design alternatives achieve to provide energy to the farm accomplishing with the most important criteria established. And all of the solutions are environmentally-friendly.

Therefore the selection among the different designs will according to the rest of the criteria. The second criterion states that the solution should grand supply energy safety and reliability, then we can discard the all solar panels solutions, because of solely focusing on solar energy

and taking into account the previously mentioned, it will not provide a continuous supply along the months.

By a similar reason, the second design option of solar panels plus a small turbine of 750 W can be discarded, too. Although it gives more energy safety, the difference is small, and the addition of the turbine is almost as the first design with an increased inversion, that makes almost no difference.

Then the final design solution will be between the third and fourth solutions. The difference between them is just the installation of a bigger turbine 6000 w and a smaller 3000 w, for the 4° and 3° solutions, respectively.

But the fourth design requires a bigger inversion Table 1 (see third criterion), so the third solution will be chosen, since it has the best balance out of the four solutions according to the criteria.

### 1.6.2. Final design solution

The chosen design is then the installation of 52 solar panels of the brand **Tamesol** model **TM-M672340** of 340 W. In addition, to make the hybrid system, a 3000 W wind turbine of the brand **Enair** model **E-30 PRO** is required. The reason followed upon choosing the solar panel model can be seen deeply explained at Selection of solar panel model.

The solar panels will be installed at a 50° degree angle to the ground, on the roof, facing to south. The roof is constructed with a 40-45° degree angle. The separation among panels, starting from the one located on the lowest point of the roof to avoid shadowing is of at least 9 cm on the roof plane (Check Distance between panels on roof installation for further information).

The configuration of the solar panels will be two groups of 28 and 24 panels. The group of 28 panels connected in 7 strings connected in parallel, each string consists of 4 panels connected in series. The second group of 24 panels will be connected in 6 strings in parallel, each string made of 4 panels in series.

The strings of panels are firstly connected in series and then connected in parallel at the combiner boxes, one box for each group of panels, following the combiner boxes, where the protection elements are located. Each group of panels is connected from the combiner boxes to the charge regulators, in this case 2 charge controllers connected in parallel model **SmartSolar MPPT 250/85** from the company **Victron Electron**.

All the control elements such as the charge regulator, battery system and inverters are installed in a proper room. The connection lines between the different elements will be protected against over-currents and short-circuits by fuses and circuit breakers for the DC part as for the AC part. A distribution panel will be installed close to the inverter, from it different



cables will emerge to the house and production area, under tube or another proper installation method.

A grounding system connects the neutral and masses of the solar panels, combiner boxes, wind turbine, turbine's regulator and charge regulators. For the DC part of the installation another grounding for the inverter and distribution panel masses and neutral will be suggested, so the differential protection in the house and production area can work in case of an isolation fault and to protect against indirect contacts. Circuit switch openers will be recommended to be installed at the combiner boxes of each group of panels so the panels can be disconnected for maintenance operation.

The solar panel system is expected to produce at least for 20 years, although the degradation rate is of 20 % normally within 20 years, the manufacturer states that the solar panels will still produce at 80 % of its original performance for 30 years in the future.



**Figure 23: Installation place of the solar panels. Source: Own**

The battery system consists of 40 battery blocks, model **12 CS 11P** rated at **12 V** each block is from the company **Rolls**. The configuration of the battery system is made by connecting lines of 4 batteries connected in series and 10 lines of 4 batteries connected in parallel. This is done because the chosen working voltage of the system should be **48 V**.

The battery system could be either installed in the house's cellar or inside a small house close to the main house, where the actual diesel generator system is placed now. For this case study the location showed at Figure 24 will be the one suggested to install the battery system, charge regulators and inverters.



**Figure 24: Possible install location for the battery system. Source: Own**

The production of energy from the solar panels, wind turbine and the one, which comes from the battery system is DC<sup>17</sup>, so inverters are needed to convert it to AC<sup>18</sup>. The chosen inverter is the model **Phoenix Inverter 48/5000** from the company **Victron Energy**. Two inverters are needed, connected in parallel.

The wind turbine has its own charge regulator for the battery system included within the price, model **RCE-ENAIR-120** with an elective working voltage of 24/48V. The charge controller has a series of 8 selectors that allow to choose the mentioned working voltage, the algorithm for the battery system, on and off position etc... The installation turbine's charge controller should be done in an interior location, as it is not suitable for corrosive environments, and it is vulnerable to water.

The wind turbine installation could be done either on the house roof or close to the house on a free standing tower or a guyed one. The height of the tower is important, because the higher it is, the more production will be achieved. The wind turbine's manual recommends to install it **10 m** higher, compared to the closest obstacle, and at a distance of double of that obstacle's height. Therefore a possible installation for the turbine could be on a tower, which is **15 m** tall and **10 meters** away from the house, as the house's height is around **5 m**.

The installation methods are only mentioned as a possible suggestion in this case study, as it was previously mentioned, we will not get into details regarding installation methodology.

An optional solar collector could be added to supply sanitary heated water for the house, its sizing feels out of the reach of this case study, so it will be only suggested.

<sup>17</sup> DC: Direct Current

<sup>18</sup> AC: Alternating Current

## 1.7. Impact of the project for the rural development

The previously exposed system composed of solar panels, wind turbine, electronics, connecting lines etc... has a positive and negative impact on the environment, which goes from its production time till its final expected life.

### 1.7.1. Environmental impact

Almost all the pollution/waste that solar panels produce comes from the raw material collection for its production and the construction itself.

Silicon is most commonly used in PV systems. The main process for solar panel production is the purification of the silicon to obtain the pure crystals. Solar panel manufacturing needs diffusion, oxidation and connects the steps, for which different amounts of chemicals are used. These chemicals are either disposed or recycled as much of them, as it is possible, and disposed in a controlled manner.[4]

So the PV panel production has very little impact on the environment, if the control process is correct, and the disposal of the different chemicals is done in a controlled manner.

Other elements of the off-grid system that could represent an environmental impact are: battery system, different electronics (inverter and charge regulator) and the different structures and materials such as: steel, copper.

The battery system is especially dangerous for the environment, due to its composing materials: sulphuric acid and lead. The acid has a risk of leakage and possible acidity of the ground, and since the lead is a heavy metal, it is toxic for the wildlife and the environment.

Therefore a correct maintenance of the battery system, and the proper disposal is critical in order to minimize its impact on the environment at the end of its life.

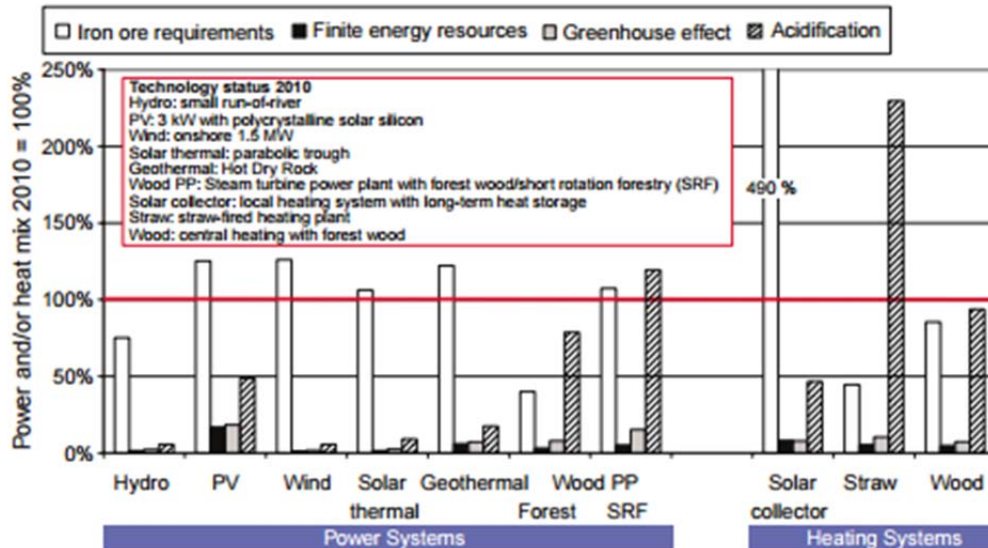

**Figure 25: LCA for different renewable types of energy productions. Source:[18]**

At Figure 25 we can see the different resources, GHG emissions and acidification from each renewable technology. We can see that wind and PV systems are almost identical, the PV GHG emissions and acidification are higher, mainly due to the chemicals and processes followed during the production of silicon crystals. The acidification will be higher for PV systems with battery system.

#### 1.7.1.1. Land Use

The main disadvantage of solar panels is the large amount of land they use. Because of that commercial solar panels have low efficiency (Although it is improved almost every year). The main possible problem of land use in solar systems could be that they occupy agriculturally usable land. Big solar production plants need to choose carefully its place of installation, so the previously stated conflict does not exist.

In the case study it is not a problem, because the installation will be done on the roof, and not on a non-harvestable ground.

#### 1.7.1.2. Water Use

Compared to other renewable energy production systems, photovoltaic panels do not require special amount of water for their production and operation.

#### 1.7.1.3. Energy demand

For producing the main element of the off-grid system, the elements are the solar panels and the wind turbine. But because the installed solar power is much higher than the installed wind power, it can be neglected.

The energy needed for the production of solar panels (see Figure 25) is not really different from other renewable sources.

#### 1.7.1.4. Visual impact

Although visual impact is a highly subjective question. In the case study the system is installed in a farm isolated from any nearby houses or population (the closest population is 5 km away).

Then no visual impact on any problematic area (the installation of solar panels can be restricted or forbidden on historic elements in cities). But in this case as it is a farm in the middle of the countryside, the visual impact feels to a subjective matter and every person will perceive the impact on a higher or lower manner.

The highest visible element is the wind turbine, which stands up on a **15 m** tower.

#### 1.7.1.5. Noise impact

Solar panels do not make any noticeable noise during their normal operation. The main noise from the solar panels will come during their production and installation process (trucks etc...).

The wind turbine produces **48 db** noise during normal operation, which is lower than a conversational speech at **60 db** and is the same level as a working fridge.

So we can state, that the noise impact of the whole installation is almost negligible.

#### 1.7.1.6. Air pollution and greenhouse gas emissions

The production of polycrystalline solar silicon panels causes green gas emissions of around **99 g CO<sub>2</sub>/Kwp**[18] and an on-shore wind turbine emits around **10.2 g CO<sub>2</sub>/Kwp** [18].

The **60%-70%** of the total gas emission of PV systems comes from the production, extraction, the manufacture of the module, installation and construction. From **21%-26%** of the total GHG emission comes from the power generation and maintenance, and between **5-20%** from the plant decommissioning and disposal.[19]

So we can see that most of the PV total GHG emission is from production, whereas for a typical coal powered generation plant **98%** of total GHG comes from coal mining, coal preparation, combustion, transport and power plant operation, with an average of **1000 g CO<sub>2</sub>/Kwh**[19]

Considering that the burning of diesel fuel emits around **10.21 Kg CO<sub>2</sub>/gallon**[20], which is **2.69 Kg CO<sub>2</sub>/Litre** in litres.

The total system production pollution is the following:

	Kw.Installed (kW)	CO <sub>2</sub> g/Kwp	Total.CO <sub>2</sub> g
<b>Panels</b>	17,68	99	1750,32
<b>Turbine</b>	3	10,2	30,6
		<b>Total:</b>	<b>1780,92</b>

**Table 2: Total GHG emissions from the production of the renewable generators.**

The operation of the renewable system will save a total amount of greenhouse emissions and avoids the use of the diesel generator. The use of the diesel generator emits GHG and different amounts of substances to the atmosphere. Then the GHG avoided will be the amount that the generator would have emitted in case it was still in use.

These are two possible scenarios:

	Yearly energy demand (Wh)	Generator (Kw)	YearHours	Litres/h	LitresDiesel	DieselCO2	Total emission saved
0% use of the diesel generator	7798039,643	5000	1559,60793	6	9357,64757	2,69	25172,07197
25% use of the diesel generator	5848529,732	5000	1169,70595	6	7018,23568	2,69	18879,05398

**Table 3: Total emission saved from the use of the hybrid system.**

So we can see that the installation of the solar panels plus the wind turbine avoids the emission of **25,172 Tons** of CO<sub>2</sub> to the atmosphere in the best scenario, and **18,87 tons** for a use of **25 %** of the total energy production from the diesel generator.

#### 1.7.1.7. Ecosystem disturbance

The National Park of Ceahlău is 14 km far away, in proper distance to consider that neither the solar panels nor the wind turbine will have any influence on its ecosystem and wildlife.

The area where the farm is in a high area with few vegetation around, so the impact on the close wildlife is negligible.

The most possible disturbance will come from the wind turbine, since it is the highest object on the area, with birds in the area.

#### 1.7.1.8. Recycling, waste production and management

The life expectancy for the usual PV system is of around 20-30 years. The life expectancy for the battery system is of around 10 years, with a needed change of around 2-3 times along the PV system's life. The expected life for the selected wind turbine is of 25 years.

The recycling and management of the wastes such as electronics (charge controllers, inverters), batteries and cable are fully developed and proven technologies.

Other possible waste such as the installation structure, materials such as steel, aluminium etc.. can be easily recycled based on well-developed methods such as re-casting etc...[4]

A good waste management politics for the battery system is expected to apply, to correctly manage its process.

Most of the installed solar panels around the planet are still in service at the moment, so common management policy for this type of waste has to be developed yet.

### 1.7.2. Social and rural impact

The area where the farm is located in Neamt county has one of the highest deprivation indicator in Romania, the construction of this index takes into account the unemployment rate, percentage of houses with electrical installation etc...[21] The employment rate for men and women for Neamt County is of 71,4% and 62,1%, respectively, with an average of 66,8% for both sexes for the year 2014. We can see a difference in unemployment between men and women, this gap aggravates the emigration of the women from the rural areas, due that they go to the cities to find better opportunities.

Romania also has one of the highest risk of poverty and social exclusion rates of the EU<sup>19</sup>, only Bulgaria is behind, with a 37.3 % rate [22]. Neamt County has one of the lowest average monthly nominal salaries of all Romania with 1645 Lei beating only two other counties[23]. Then it is clear that the electrical safety supply and electricity production independence is a key factor that could help not only for this case study but could be also used for Neamt county region and employment that goes linked to the development of renewable technologies in the area.

The economy of Neamt county is mostly based on agriculture, silviculture and animal breeding. The share of occupied population is pretty high, 46,84 % for agriculture, superior to the national level of around 29.48 %. [24] The north-east region (area where Neamt county is located) owns 14,47% of Romania's agricultural and 18,26% of forest covered area.

Silviculture has a high level of production in the area, considering that Neamt county has around 260.620 ha of forest. The north-east area supplies 28,28% of the total wood volume in Romania per year [24].

Examining the industry, the most active sectors in the area are:

- Machinery industry, engineering
- Food industry
- Wood, cellulose and paper manufacturing industry and furniture

---

<sup>19</sup> European Union

- Light industry
- Tourism
- Medicines
- Transports

We can see that the area has a heavy dependency especially on the agriculture and sylviculture, as they represent almost the 50% of total employment in the area.

The area has a problem to keep the production since young population goes to urban areas and more than 28% of the population that stays there is over 60 years of age. From 1992 to 2011 Neamt County lost around 106.853 people, because of the emigration abroad or emigration inside Romania.[23]

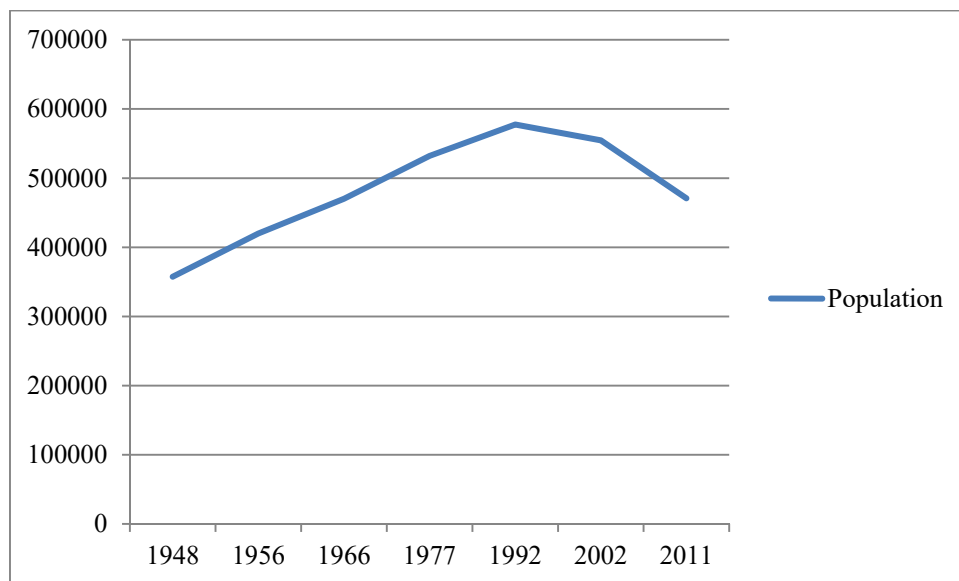

**Figure 26: Population evolution in Neamt county. Source: INSSE**

In addition, the natural growth is slowing down in the area, which means that more people die, than were born, 2656 people less were born in 2011 [23].

### 1.7.2.1. Energy security

Off-grid systems like the one described in this case study can guarantee the energy supply (as a backup or as a main source of supply) on areas where is difficult to provide energy supply, or it is expensive. The renewable systems can act as a backup for traditional system, where due to external factors there is a shortage of energy supply.

The farm examined in the case study initially had a problem with energy security, where the voltage that the generator could supply is lower than the nominal voltage of 230 V. The hybrid installation helps the energy security problem.



### 1.7.2.2. Rural electrification

The distributed generation of electrical energy that the renewable system can achieve could be the key solution to provide electricity to the few percentage of the population, because of a series of factors the conventional supply of electricity is not possible, difficult or too expensive. Because of its unique nature, renewable technologies can act as isolated points of production, what eliminates the problem to connect an isolated household by cable. In Romania around 45.5 % of its total population lives in rural areas in Romania. These kinds of technologies could be a perfect solution for these scenarios.

Renewable energy technologies also could help in rural areas as the ones we can find in Neamt County, acting as backup to traditional ways of energy producing and fomenting the increase of production. Examples could be the use of biomass related products that could come from the agriculture sector present in the region

### 1.7.3. Climate change mitigation

The system installed for the farm saves the atmosphere from around **25,17 tons** of CO<sub>2</sub> every year, as we have seen previously. The energy production generates around **29%** of total GHG emissions in the US, for example [25]

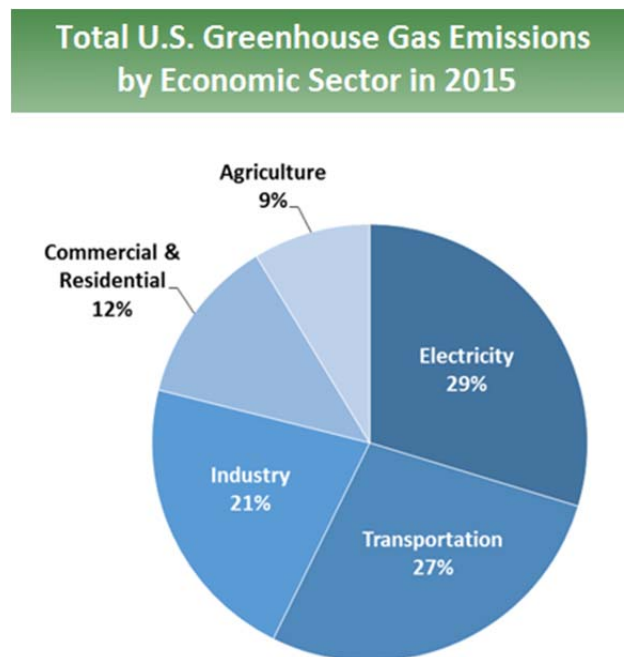

**Figure 27: Origin of the GHG by source in the USA. Source: EPA**

Also the losses due to the transportation of the electricity are around **21.5%** in Europe [13], this is mainly due to the long distance of transportation and losses due to heat losses etc...

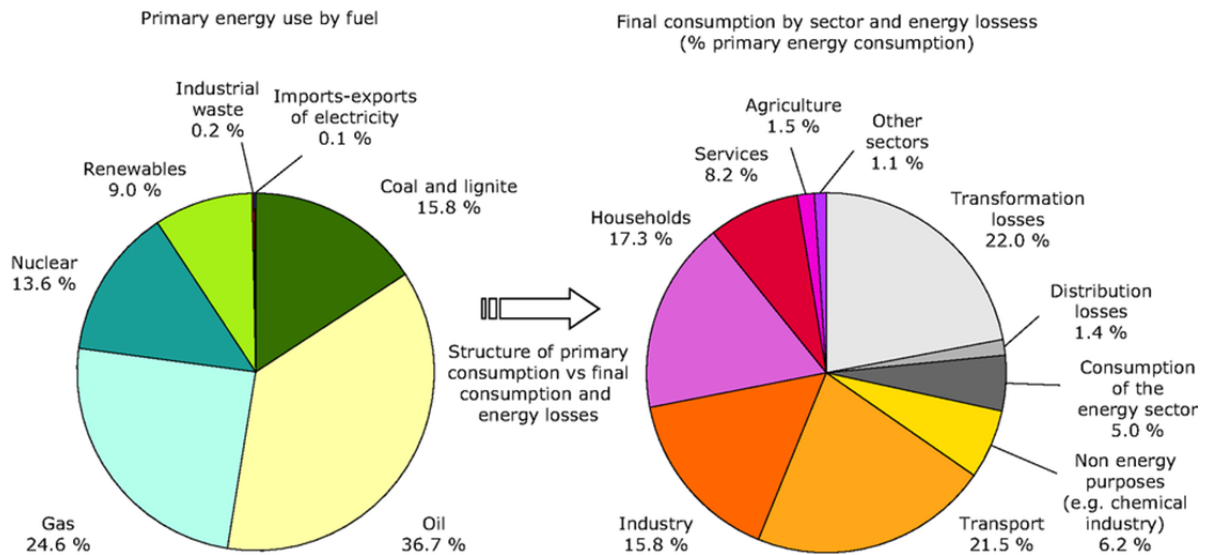

**Figure 28: Primary consumption vs final consumption and energy losses. Source: EEA**

Therefore renewable distributed supply can help the both previously mentioned statements. A distributed supply does not have the same loss issues as a centralized traditional supplier.

Traditional production power plant also works with oil, gas and coal, that emits a huge amount of GHG to the atmosphere (see Figure 28)

#### 1.7.4. New jobs and business opportunities

The renewable market generates more employment directly and indirectly as well, than traditional centralized power supply, because of more amount of production points and because the systems need maintenance, too.

Therefore, different kinds of employment levels are generated:

- **Direct:** employment from the engineers etc.. who work on the development, and sizing of the installation. Personnel for the construction and installation of the system and qualified personnel for the maintenance etc...
- **Indirect:** Manufacturers of the components of the installation, distributors of the pieces and components. Possible new workers on the farm due to the savings from the installation that allow to increase the working force.

So the spread of these kinds of technologies around the area could promote the creation of more work places around the area and even around the country.

Possible bigger territorial involvement with bigger renewable projects, as for example the installation of a cogeneration plant fuelled by biomass or the installation of a community solar panel system that generates power for the whole village, could mean the creation of much more job positions not only in the village, but in the whole county. These changes could mean the improvement of the social situation and the possible improvement of life quality and a more stable population.

## 1.8. Conclusions

Here come the conclusions and the summing up of the case study. The farm had a lot of energy needs, but due to its difficult geographical location, the normal way of energy supply was not possible, especially from economical aspects.

The solution design in this project can provide more than enough energy production and most importantly **security** of the energy supply thanks to the installation of the wind turbine backup as a battery charging supporter. The use of only renewable solution is a strength on ecologic way of thinking, with the avoidance of **GHG emissions** on operation and the end of the dependence on the traditional supply power plants.

But the most important strength on this project solution is, that it is a complete solution that fully satisfies the client's needs.

Weaknesses of the project are, that the amount of panels needed is quite large, and the initial investment is quite high, with a late payback of the investment. Other weakness could be that there are much more equipment for the balance of the system, the maintenance will be much tedious than a simpler solution's (a bigger diesel generator for example) and more expensive **O&M**.

## 1.9. References

- [1] Wikipedia, “Neamt County.” [Online]. Available: [https://en.wikipedia.org/wiki/Neamț\\_County](https://en.wikipedia.org/wiki/Neamț_County).
- [2] “Lake Izvorul Muntelui - Wikipedia.” [Online]. Available: [https://en.wikipedia.org/wiki/Lake\\_Izvorul\\_Muntelui](https://en.wikipedia.org/wiki/Lake_Izvorul_Muntelui). [Accessed: 30-Mar-2017].
- [3] “Energy on a Sphere.” [Online]. Available: <https://sos.noaa.gov/Datasets/dataset.php?id=579>. [Accessed: 03-Apr-2017].
- [4] a Goetzberger and V. U. Hoffmann, *Photovoltaic Solar Energy Generation*. 2005.
- [5] “How do Photovoltaics Work? | Science Mission Directorate.” [Online]. Available: <https://science.nasa.gov/science-news/science-at-nasa/2002/solarcells>. [Accessed: 04-Apr-2017].
- [6] S. Energy, “Photovoltaics report,” no. November, 2016.
- [7] M. Pareja A., “Energía Solar Fotovoltaica,” p. 165, 2010.
- [8] “Understanding Coefficient of Power (Cp) and Betz Limit.”
- [9] Iec, “Wind turbines – Part 2: Design requirements for small wind turbines,” 2006.
- [10] © M Ragheb, “CONTROL OF WIND TURBINES,” 2016.
- [11] Seia and SolarPACES, “Concentrating solar power : Energy from mirrors,” *Energy Effic. Renew. energy*, pp. 1–8, 2001.
- [12] E. Dans, “The future of energy is distributed generation | Enrique Dans | Pulse | LinkedIn.” [Online]. Available: [https://www.linkedin.com/pulse/future-energy-distributed-generation-enrique-dans?trk=v-feed&lipi=urn%3Ali%3Apage%3Ad\\_flagship3\\_feed%3BR7GnERkqu738MFp7I7%2BWrw%3D%3D](https://www.linkedin.com/pulse/future-energy-distributed-generation-enrique-dans?trk=v-feed&lipi=urn%3Ali%3Apage%3Ad_flagship3_feed%3BR7GnERkqu738MFp7I7%2BWrw%3D%3D). [Accessed: 02-Apr-2017].
- [13] EEA, “Energy efficiency in transformation — European Environment Agency.” [Online]. Available: <http://www.eea.europa.eu/data-and-maps/indicators/energy-efficiency-in-transformation/energy-efficiency-in-transformation-assessment-3>. [Accessed: 05-Apr-2017].
- [14] World Energy Council, “E-storage : Shifting from cost to value. Wind and solar applications,” *World Futur. Energy Summit*, pp. 1–14, 2016.
- [15] T. Solar and P. Magazine, “PHOTON magazine,” 2017.
- [16] “Can Redflow’s Home Flow Battery Really Beat Lithium-Ion? | Greentech Media.” [Online]. Available: <https://www.greentechmedia.com/articles/read/can-redflows-home-flow-battery-really-beat-lithium-ion>. [Accessed: 06-Apr-2017].
- [17] M. A. Eltawil and Z. Zhao, “MPPT techniques for photovoltaic applications,” *Renew. Sustain. Energy Rev.*, vol. 25, pp. 793–813, 2013.
- [18] M. Pehnt, “Dynamic life cycle assessment (LCA) of renewable energy technologies,” *Renew. Energy*, vol. 31, pp. 55–71, 2006.
- [19] G. Heath and D. Sandor, “Life Cycle Greenhouse Gas Emissions from Solar Photovoltaics (Fact Sheet), NREL (National Renewable Energy Laboratory).”
- [20] U. Epa and C. for Corporate Climate Leadership, “Emission Factors for Greenhouse Gas

Inventories.”

- [21] A.-M. Burlea and I. Muntele, “GEOGRAPHIC AND SOCIO – ECONOMIC HEALTH INEQUALITIES IN NEAMT COUNTY, ROMANIA,” vol. 7, no. 1, 2013.
- [22] “People at risk of poverty or social exclusion - Statistics Explained.” [Online]. Available: [http://ec.europa.eu/eurostat/statistics-explained/index.php/People\\_at\\_risk\\_of\\_poverty\\_or\\_social\\_exclusion](http://ec.europa.eu/eurostat/statistics-explained/index.php/People_at_risk_of_poverty_or_social_exclusion). [Accessed: 31-May-2017].
- [23] “Sustainable Development Indicators | National Institute of Statistics.” [Online]. Available: <http://www.insse.ro/cms/en/content/sustainable-development-indicators>. [Accessed: 31-May-2017].
- [24] “Economic sectorial structure Agriculture and sylviculture,” 1998.
- [25] O. US EPA, “Sources of Greenhouse Gas Emissions.”
- [26] “Instalaciones interiores en viviendas número de circuitos y características ITC-BT-25.”
- [27] “Cuánta energía consume una casa.” [Online]. Available: <https://www.ocu.org/vivienda-y-energia/gas-luz/noticias/cuanta-energia-consume-una-casa-571584/>. [Accessed: 11-Apr-2017].
- [28] “Residential Energy Consumption Survey (RECS) - Data - U.S. Energy Information Administration (EIA).” [Online]. Available: <https://www.eia.gov/consumption/residential/data/2015/#lighting>. [Accessed: 25-Apr-2017].
- [29] “Solar Energy | SEIA.” [Online]. Available: <http://www.seia.org/about/solar-energy>. [Accessed: 16-May-2017].
- [30] D. C. Jordan and S. R. Kurtz, “Photovoltaic Degradation Rates -- An Analytical Review: Preprint.”
- [31] *UNE 20460-5-523*. .
- [32] IDAE, “Pliego de condiciones técnicas de instalaciones conectadas a la red.”
- [33] “ENF List of Solar Companies and Products - Including Solar Panel and Inverter PV Manufacturers.” [Online]. Available: <https://www.ensolar.com/>. [Accessed: 06-May-2017].
- [34] J. N. Mayer and D. S. Philipps, “Current and Future Cost of Photovoltaics Current and Future Cost of Photovoltaics,” 2015.



# Calculations



**Compilation of case studies of applying renewable energies to local development transnationally implemented**



Co-funded by the  
Erasmus+ Programme  
of the European Union



## 2. Calculations and design

### 2.1. General information

The farm produces dairy products. It is divided into two parts: a working area on the left (Figure 29) and a house on the right (green roof).

As mentioned before the farm is 5 kilometers far away from Călugăreni's terms (Neamt county, Romania).



**Figure 29: General overview of the farm**

**Location:** Bacău, Neamt County (Romania)

**Coordinates:** 47°04'19.2"N 25°56'06.1"East

**Elevation:** 864 m above sea level

The energy what the farm requires can be divided into two parts: Electrical and Heat needs.

The production part of the farm is used the whole week, while the house is kept for use during weekends by the owner. We see that two clearly different parts exist, the production area of the farm, and the house itself.

The method for sizing the installation, will be choosing for the least favorable month, this means the month when the solar irradiation is the lowest throughout the year.



## 2.2. Sizing process guideline

Before jumping right into the calculation process, a guide will be established in order to make easier to follow the whole process.

The process for sizing the installation will be as follows:

1. **Calculating the power needed for the installation**
2. **Measuring the wind and sun resources**
3. **Small wind turbine sizing**
4. **Photovoltaic installation sizing**
5. **Sizing of the battery system**
6. **Inverter and regulator**
7. **Connection lines between elements**
8. **Protections**
9. **Others**

The exact reasons why certain elements were chosen etc... has been exposed on previous chapters of this case study, so in case of doubt about some of the aspects about to be exposed check part 1.5 and 1.6, where the reasons are deeply explained.

Calculations also will be included in this section, such as emissions to the atmosphere saved thanks to the installation. The distance needed between the solar panels, the selection of the type of solar panel etc..

### 2.3. Power needs of the installation

The installation consumptions can be divided into two parts: Consumptions related to production and consumptions related to the house. All consumptions of the farm are considered to be AC.

The production part consumes the most; it has two elements, an electrical boiler and a refrigeration device. The boiler is used along the year used for the production of dairy products, boiling milk and other elements for the elaboration of different products. The fridge is in continuous use to preserve the dairy products.

- **Electrical boiler:** Power: 2000W
- **Industrial fridge:** Power: 750W

On the other part, the house has a basic electrification degree. It has the following elements:

- **Fridge:** Power: 150W
- **Cleaning machine:** Power: 1000W
- **Electrical stove:** Power: 2000W
- **Lights:** Power: 40W Amount: 20
- **Power sockets:** Power: 3450W Amount: 10
- **Water pump:** Power:  $\frac{1}{2}$  CV $\approx$ 367,5W

Also the house has heating system which is used in winter during the three coldest months.

Now that we have the power needs we will need now the Wh/day that the installation consumes every day. This is needed for the sizing of the power generation system. A series of factors will be used, so the installation is not oversized, these factors are taken from the Spanish regulation ITC-BT-25 [26]

For the amount of hours of use for each element a combination of collected data from the owner, studies of use [27][28] and own consideration has been followed.

We know the **boiler** is used all around the year for a total of **2100h/year**. The rest of the elements need to be studied in order to determine the amount of hours they are used.

- **Fridge and Industrial fridge:** Around 8 hours every day. And they work 7 days/week
- **Cleaning machine:** Considering that the house is used on weekends. 1 hour/day and 2 days/week of use.
- **Electrical stove:** 2 hours of use a day for 2 days/week
- **Lights:** 6 hours of use during the low light parts of the day
- **Power sockets:** A maximum of 2 hours a days for the weekend
- **Water pump:** 3 hours of use per day.

Let's take a look then at Table 4 to see all the previously mentioned information together.

	Power (W)	Hours	F.Simult	F.Use	Days/week	Weeks/year	Wh/year:	Wh/day
<b>Boiler</b>	2000	5,753424			7	52,1428571	4199999,52	11506,848
<b>Ind.Fridge</b>	750	8			7	52,1428571	2190000	6000
<b>C.machine</b>	1000	1			2	52,1428571	104285,714	285,714286
<b>Elec.Stove</b>	2000	2	1	0,75	2	52,1428571	312857,143	857,142857
<b>Fridge</b>	150	8	1	1	7	52,1428571	438000	1200
<b>Lights</b>	800	6	0,3	0,75	2	52,1428571	112628,571	308,571429
<b>Wat.Pump</b>	367,5	3	1	0,7	2	52,1428571	80482,5	220,5
<b>Sockets</b>	34500	2	0,2	0,25	2	52,1428571	359785,714	985,714286
<b>Total:</b>							<b>7798039,16</b>	<b>21364,4909</b>

**Table 4: Power consumed by the farm daily**

We can see at the upper table the factors we previously mentioned, let's define them, for the better understanding, what they are used for:

- **Factor of simultaneity:** It represents, of all the total elements of the same type, for example the 20 lights, the amount of them that on a normal use can be simultaneously connected. For example for the 20 lights applying the 0,3 factor we get that maximum around 6 lights are connected at the same time
- **Factor of use:** This factor states the percentage of the total power used on a normal basis.[26]

Note that for the Lights and the Sockets the power has been multiplied by the total amount of plugs and light points to be present in the house.

In Table 4 can be seen what will be used in the following chapters for the sizing of the installation, the **total Wh/ year** in blue and the **total Wh/day** in orange. These are the values of the annual and daily energy requirements.

The power consumption from the production part (**Boiler+Ind.Fridge**) represents more than 75% of the all total consumption of the farm.

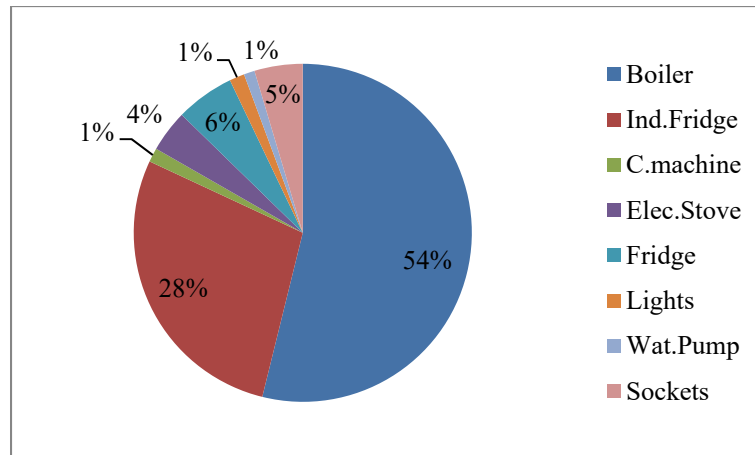

Figure 30: Daily consumption by the different elements

#### 2.4. Measuring the sun and wind resource

Now we need to know the potential energy we can use from the sun and wind, so we can size the installation.

The sun resource is the most abundant energy resource on the earth [29]. Measuring the irradiation along the year on a certain area can be done through different databases available for the different countries and regions.

In this case study the free access database [PVGIS](#) financed by the European Union will be the one is used to estimate the solar resource available monthly for the location of the farm.

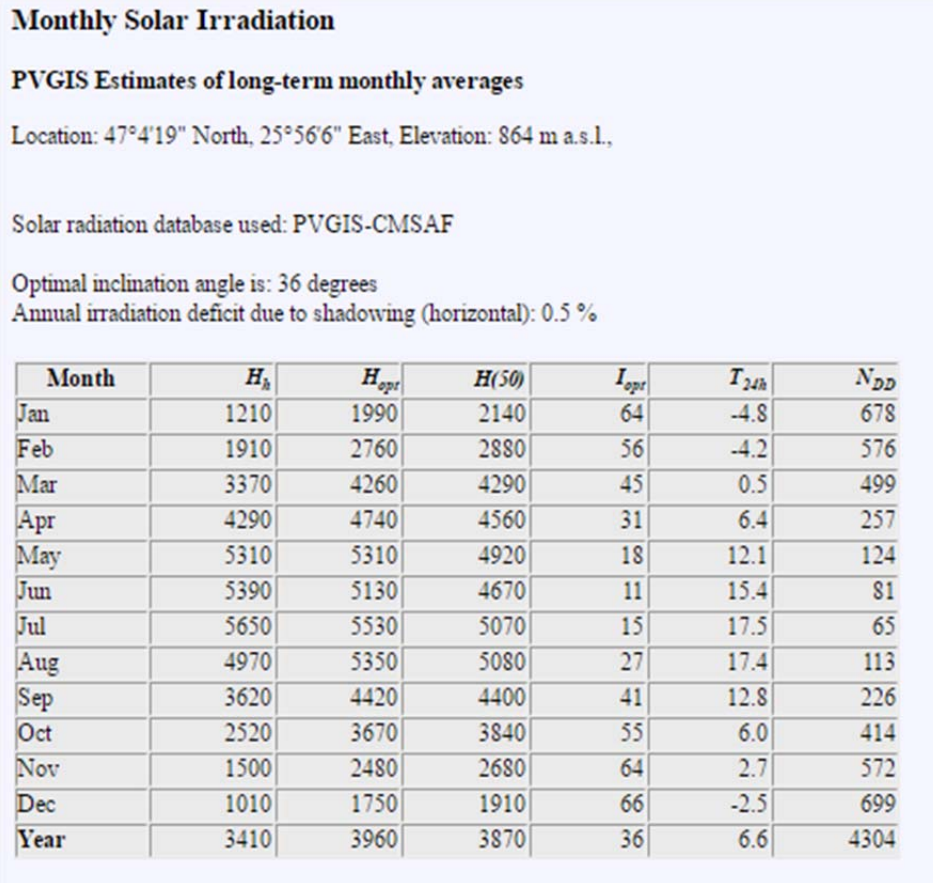

**Figure 31: Monthly irradiation values. Source: PVGIS.**

Hh: Irradiation on horizontal plane (Wh/m<sup>2</sup>/day)

Hopt: Irradiation on optimally inclined plane (Wh/m<sup>2</sup>/day)

H(50): Irradiation on plane at angle: 50deg. (Wh/m<sup>2</sup>/day)

Iopt: Optimal inclination (deg.)

T24h: 24 hour average of temperature (°C)

NDD: Number of heating degree-days (-)

We can see at Figure 31: Monthly irradiation values. Source: PVGIS. Figure 31 the different irradiation values for the different angles. The one we will use from this point will be the column of  $H(50)$  these are the amount of solar energy arriving at the installed angle of the installation: 50°

It can be seen that PVGIS itself suggests an optimal average angle to obtain the maximum output without changing the solar panels' angle. The reasons for choosing this angle have been already stated on previous chapters.

PVGIS also gives graphs representing the irradiation for the different angles we choose, see Figure 32. We can see that at 50° degrees we get a bit more of power at winter, which is the critical period where earth receives the least sunlight.

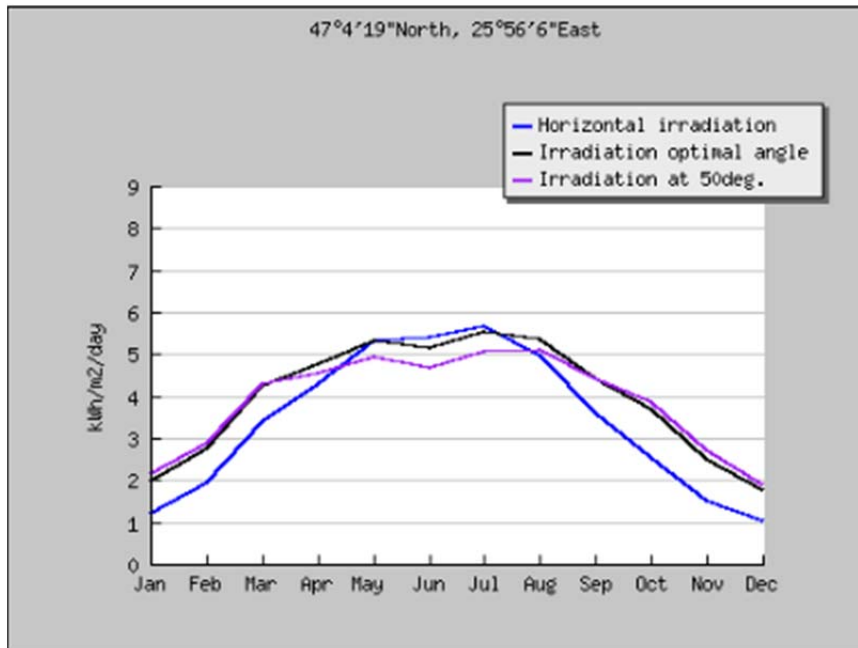

**Figure 32: Irradiation along the year for the different angles. Source: PVGIS.**

PVGIS gives a view of the obstacles and possible shadows that can occur along the year. The sun in winter hits the earth at a much sharper angle than in summer, this makes that the total amount of sun hours in winter is much less. Therefore, studying the losses due to possible objects blocking the solar panels from the sunlight is especially important in places like cities etc... In the case study the panels are situated high and facing south, so no losses due to shadows are considered.

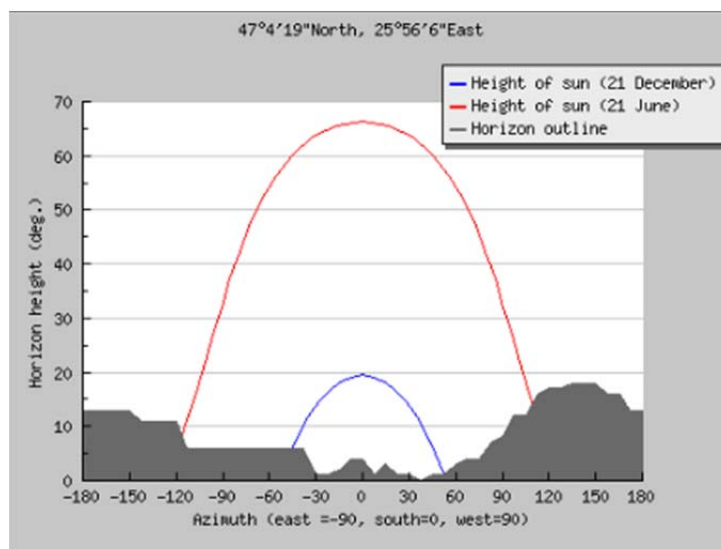

**Figure 33: Yearly solar path. Source: PVGIS.**

Wind resource availability on the other hand, is much harder to determine because it does not only change on a global level, but wind heats up at the equator and rises to move to one direction and goes to the opposite in colder regions, but also changes due to local geography (mountains, valleys, sea present or not etc..).

All this makes wind a hard thing to quantify and more importantly predict. Although now every country more or less disposes of its own wind atlas, e.g. <http://atlaseolico.idae.es/> for Spain. A deep study of the area is needed to measure the wind frequency and speed.

For measuring the power produce by the small wind turbine the speed of the wind and the amount of hours it blows are needed.

A rose of wind is a common graph that displays the speed of the wind, its direction and frequency (amount of hours). On Figure 34 we can see the rose wind for the village of Calugareni. It is noticed that wind blows mostly from South-West direction.

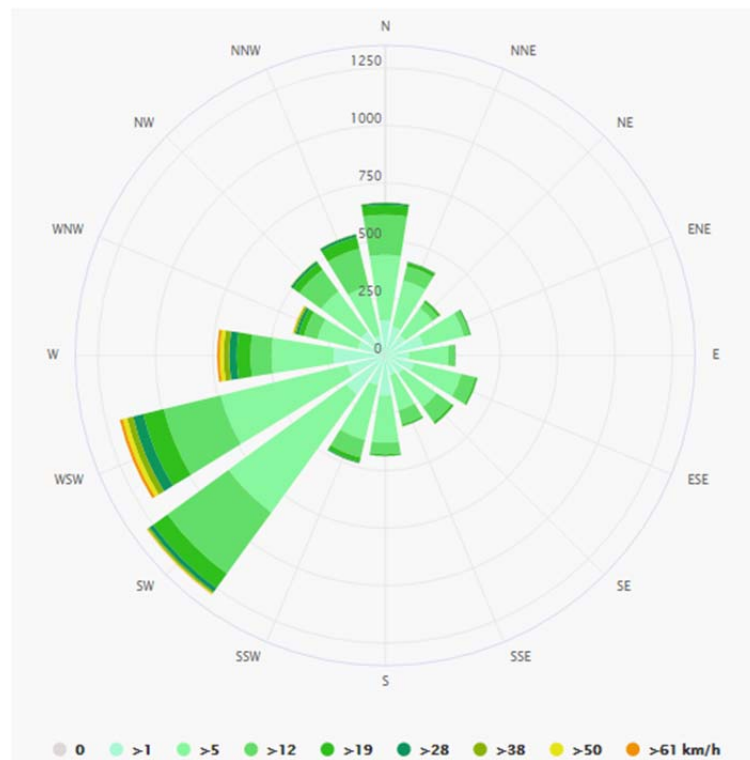

**Figure 34: Rose of wind for Calugareni. Source: Meteoblue.**

Compiling all data from the graph we get:

Spd (km/h)	Spd(m/s)	Hours/year
0	0	79
1	0,27777778	2147
5	1,38888889	4078
12	3,33333333	1677
19	5,27777778	471
28	7,77777778	162
38	10,5555556	79
50	13,8888889	44
61	16,9444444	26

**Table 5: Wind speed and hours. Source: Own creation**

The wind speed velocity mostly groups around the speed of 1,38 m/s, this means that most of the time the wind speed is quite low. Considering that a lot of small wind turbines have a cut-in-speed lower than that value, the speeds are not ideal.

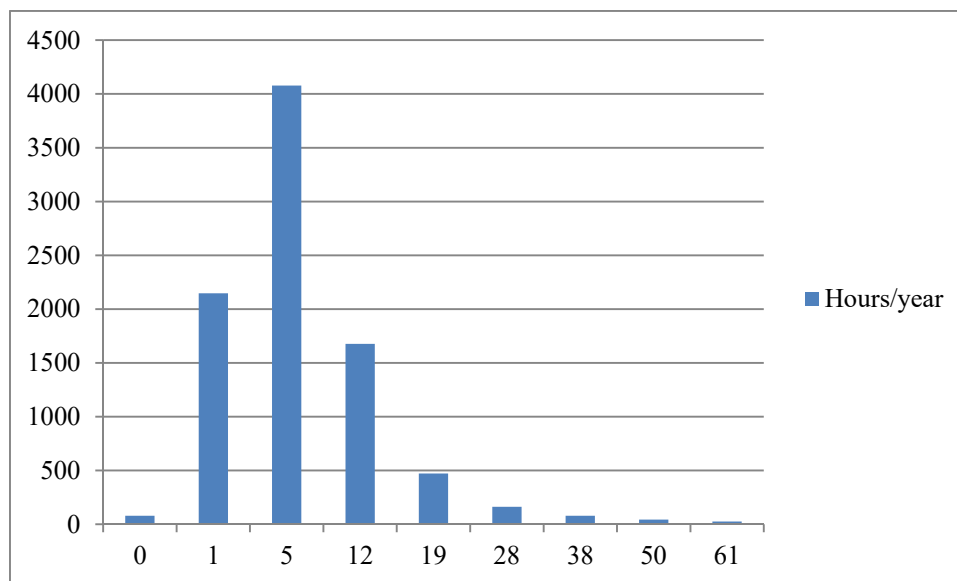

**Figure 35: Hours/year vs speed of wind. Source: Own creation**

Therefore, now we dispose all the tools needed to size the hybrid installation.



## 2.5. Small wind turbine sizing

The chosen small wind turbine is a E30 PRO by the Spanish company ENAIR. It has the following characteristics:

<b>Number of blades</b>	<b>3</b>
<b>Power output</b>	3000W
<b>Working voltage</b>	48V
<b>Weight</b>	125 kg
<b>Swept area</b>	11,34 m <sup>2</sup>
<b>Cut-in-speed</b>	1,8 m/s
<b>Nominal speed</b>	11 m/s
<b>Power control</b>	Passive by centrifugal change of pass angle

**Table 6: Small wind turbine characteristics**

For further information about the small wind turbine check the annex.

So now let's calculate the annual production of the wind turbine using the data provided by the manufacturer. Every turbine has a different  $C_p$  (power coefficient) that depends on a series of variables: tip speed ratio, the attack angle, number of blades, wind speed etc... So the manufacturer normally gives out those coefficients or directly gives the power production.

The equation for calculating the power produce by the turbine is:

$$P_{output} = \frac{1}{2} * C_p * \rho * A * v^3 \quad (4)$$

$C_p$ : Power coefficient

$\rho$ : Air density, at 15°C is around 1,255 kg/m<sup>3</sup> at sea level

$A$ : The area swept by the wind turbine

$v$ : the speed of the wind

In this case the manufacturer gives the power generated at a certain speed directly. See Table 7, the yearly production and daily production from the wind turbine can be seen. Average production could go higher or lower depending on different factors such as: Height at which the wind turbine is installed, wind change along the year etc...

			CUT-in-Speed: 1,8m/s	
Speed (km/h)	Speed(m/s)	Hours/year	Power	Wh/year
0	0	79	0	0
1	0,27777778	2147	0	0
5	1,38888889	4078	0	0
12	3,33333333	1677	180	301860
19	5,27777778	471	300	141300
28	7,77777778	162	1200	194400
38	10,5555556	79	2000	158000
50	13,8888889	44	2250	99000
61	16,9444444	26	2500	65000
			Total	959560
				2628,93151
				Wh/year
				Wh/day

**Table 7: Power production of the turbine. Source: Own creation**

Most of the production from the wind turbine comes due to low speed wind. As mentioned before by installing the wind turbine higher the power output is expected to go up.

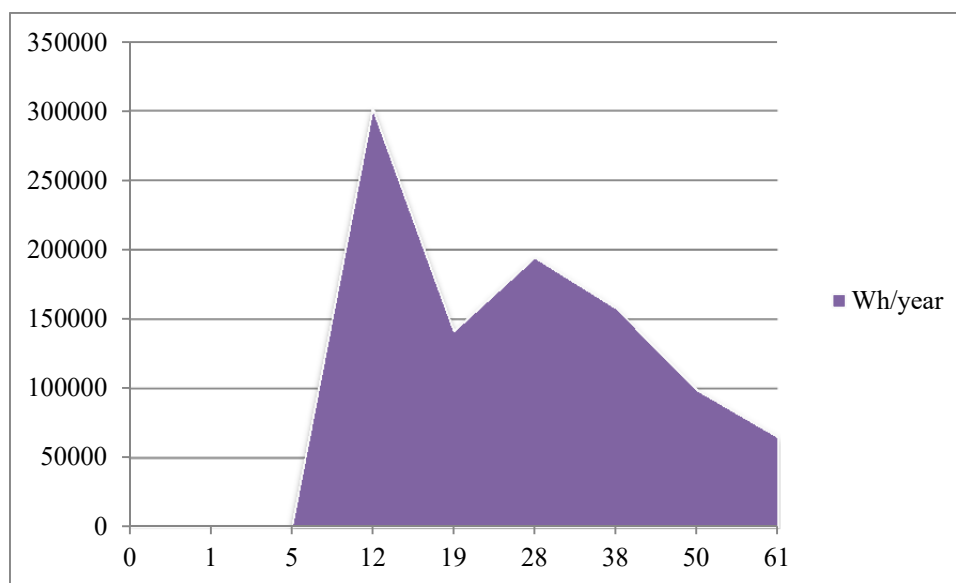

**Figure 36: Production by wind speed**

The power production achieved by the wind turbine will be taken from the daily energy needs from the farm, so we can size the photovoltaic installation on the next chapter correctly with no oversizing.

$$\begin{aligned} P_{needs} &= P_{needstotal} - P_{turbine} = 21364,4909 - 2628,93151 \\ &= 18735,5607 \text{ Wh} \end{aligned}$$

## 2.6. Photovoltaic installation sizing

For choosing the amount of panels for our photovoltaic power generation installation we need to calculate the minimum power to install, it takes into account the losses of all the systems and the least favorable month.[7]

The Performance rate (PR) takes into account all losses from the system. All elements composing the system have a performance rate, although it is usually high, the accumulation of losses from all the elements have a significant effect, especially on off-grid systems.

$$Pr = 1 - (Loss_{orient} + Loss_{shade} + Loss_{dirt} + Loss_{cable} + (1 - Perf_{inv}) + (1 - Perf_{reg} + 1 - Perf_{bat})) \quad (5)$$

Where:

**Loss<sub>orient</sub>**: Losses due to orientation of the panels. In this case the panels face south, so it is considered 0.

**Loss<sub>shade</sub>**: Losses due to other objects projecting a shadow over the panels. Considered 0 due to being on the roof and an open area (no nearby objects)

**Loss<sub>dirt</sub>**: Losses by dirt. It is considered to be around 5%.

**Loss<sub>cable</sub>**: Losses due to joule effect on the wiring. In this case they are considered to be around 5%

**Perf<sub>inv</sub>**: Performance of the inverter. For the chosen model it is 95%.

**Perf<sub>reg</sub>**: Performance of the charge regulator. For the chosen model it is 98%.

**Perf<sub>battery</sub>**: Performance of the battery system.

$$Perf_{bat} = (1 - Kb) * (1 - \frac{Ka*N}{DOD}) \quad (6)$$

Where:

**Kb**: These are the losses while charging and discharging the battery system. It is considered about 5%.

**Ka:** Self-discharge value of the battery system. For a stationary Lead acid type, the value is  $5 * \frac{10^{-3}}{\text{day}}$

**N:** Autonomy days of the battery system. For this installation 5 days are considered.

**DOD:** Maximum depth of discharging for the battery system. To protect it and maximize its life period. For this case study the DOD is 0.6.

$$Perf_{bat} = (1 - 0,05) * \left(1 - \frac{5 * 10^{-3} * 5}{0,6}\right) = 0,910417$$

Putting all the data together we obtain the performance rate of the whole system:

$$PR = 1 - (0 + 0 + 0,05 + 0,05 + (1 - 0,95) + (1 - 0,98 + 1 - 0,910417)) = 0,740417$$

Now that we have the **PR** we can correct the power needed by the installation (“**Pneeds**” previously mentioned):

$$P_{needs_{pr}} = \frac{P_{needs}}{PR} = \frac{18735,56}{0,740417} = 25304,065 \text{ Wh}$$

In numerous bibliographies, a security factor is present [7]. This factor is used for safety reason to make sure that the demand is covered, it changes from source to source, in this case study the Security Factor (SC) is **1,1** which has been used.

Also, photovoltaic degrade over time, different technologies differ on degradation over time, also the location on the globe influence[30] a **1%/year** of production loss. So we need to oversize the installation, so in a **20-year**-period it will be still able to produce enough energy.

$$P_{needs_{PRSC}} = P_{needs_{PR}} * Factor_{degrad} * Factor_{security} \quad (7)$$

Where:

**Factor<sub>degrad</sub>:** There is a 20% of loss over 20 years. The factor will be 1,2.

**Factor<sub>security</sub>:** It is 1,1.

$$P_{needs_{PRSC}} = 25304,065 * 1,2 * 1,1 = 33401,36 \text{ Wh}$$

The panel chosen is a monocrystalline solar panel, model **TM-M672320/340** from the company **Tamesol**. The characteristics of the panel are the following:

<b>Maximum Power at STC:</b>	<b>340 W</b>
<b>Optimum Operation Voltage (Vmp):</b>	37.76 V
<b>Optimum Operating Current (Imp):</b>	9.00 A
<b>Open Circuit Voltage (Voc):</b>	46.80 V
<b>Short Circuit Current (Isc):</b>	9.46 A
<b>Module Efficiency:</b>	17.51 %

**Table 8: Solar panel characteristics.**

Solar irradiation changes along the day, a common concept is used in photovoltaics, that is Peak Sun Hours (PHS). PHS is the amount of hours of **1000 W/m<sup>2</sup>** irradiation received on a day. It is used to calculate the minimum power to install

$$P_{install} = \frac{P_{needs_{PRSC}}}{PSH_{month}} \quad (8)$$

The PSH what we will take is from the least favorable month, which is December (see Figure 31). The irradiation values are from the **H(50)**, due to the fact, that that is the angle of installation.

**PSH<sub>December</sub>**: 1,910 Kw/m<sup>2</sup>

$$P_{install} = \frac{P_{needs_{PRSC}}}{PSH_{december}} = \frac{33,40136 \text{ Kwh}}{1,910 \frac{\text{Kw}}{\text{m}^2}} = 17,487 \text{ Kw}$$

Now the amount we need, considering the maximum power output for the panels is 340W.

$$Number_{panels} = \frac{P_{install}}{Power_{panel}} = \frac{17487 \text{ W}}{340 \text{ W}} = 51.43 \text{ panels} \approx 52 \text{ panels}$$

We chose the closest higher integer from the previous equation is the amount of panels to install of the photovoltaic installation.

## 2.7. Sizing of the battery system

Since the system is off-grid, as we already mentioned previously, we will need an energy store system to accumulate the excess energy.

The battery system will work at 48 V to reduce the amount of losses and lowering the current (less joule effect losses due to lower current) due to the higher voltage, to be able to install thinner cables.

The equation to calculate the amounts of Ah needed is:

$$Cbatsystem = \frac{1,1*N*Id}{DOD*Perf_{BatInvReg}} \quad (9)$$

Where:

$C_{batsystem}$ : It is the capacity needed to install in Ah

N: It is the autonomy of the battery system. Considered to be 5 days.

$I_d$ : It is the daily need from the power consumption of the farm

$$I_d: \frac{P_{needstotal}}{48 V} = \frac{21364.69 Wh}{48 V} = 445.09 Ah$$

DOD: It is the depth of discharge. In this case study it is considered to be 0,6.

$Perf_{BatInvReg}$ : It is the combined performance of the battery system, regulator and inverter.

$$Perf_{BatInvReg} = Perf_{Bat} * Perf_{Inv} * Perf_{Reg} = 0.910417 * 0.95 * 0.98 = 0.84759$$

Then:

$$Cbatsystem = \frac{1.1 * 5 * 445.09}{0.6 * 0.84759} = 4813.638 Ah$$

The chosen battery is the model 12 CS 11P, from the company Rolls. It is a deep cycle lead acid battery, a block type battery of 12 V rated voltage per module.

Since the autonomy of the system is expected to be of around 5 days, we can consider a discharge rate of 120 hours for the battery system. The lower we discharge the battery system the higher is the capacity.

Weight dry	100 kg
Weight wet	123 kg
Number cells and plates	11 plates/ cell and 6 cells
Capacity 100 hours	503 Ah
Capacity 72 hours	475 Ah
Capacity 24 hours	371 Ah

**Table 9: Characteristics of the 12 CS 11 P battery**

For the 12 CS 11P model the capacity for a 100 hour discharge is :

$$C_{bat_{100HourRate}} = 503 \text{ Ah}$$

Then the number of batteries in parallel needed will be:

$$Number_{BatteriesParallel} = \frac{Cbatsystem}{C_{bat_{100HourRate}}} = \frac{4813.638 \text{ Ah}}{503 \text{ Ah}} = 9.5698 \approx 10 \text{ batteries}$$

But the voltage we are working with is of 48 V so we will need 4 batteries in series, due to the fact that the battery chosen is a 12 V block.

So the total number of batteries as a whole will be:

$$NumberTotal = Number_{BatteriesParallel} * Number_{BatteriesSeries} = 40 \text{ batteries}$$

### 3. Choosing the inverter and charge regulator

#### 3.1. Charge regulator

The charge regulator and inverter are from the company **Victron Energy**.

Let's begin choosing the charge regulator. The parameters that will define the amount of the regulators we will have to install will depend on the characteristics of the solar panels we chose (the wind turbine has its own regulator).

The parameters we will use from the solar panels are (see Table 8) :

**Vosc:** The open circuit voltage from the solar panels,  $V_{osc}=46.80$  V.

**Isc:** It is the solar panel's short-circuit current. It is the maximum current that on normal operation, the solar panel could give. The value in the table is:  $I_{sc}= 9.46$  A

**Victron Energy** provides a group of solar charge regulators that can be connected at 12,24,36 and 48 V. The ones we will discuss are the **SmartSolar MPPT 150/85, 150/100, 250/85** and **250/100**. The first number stands for the maximum PV open circuit voltage and the second one the rated current of the regulator, e.g 150 V and 85 A.

Then:

$$Voltage_{safety} = Factor_{security} * V_{osc} \quad (10)$$

$$Current_{safety} = Factor_{security} * I_{sc} \quad (11)$$

**Factor<sub>security</sub>:** Is a security parameter to be sure we protect the regulator. The factor is normally defined as a 25% increment over the normal value[7]

$$Number_{PanelsSeries} = \frac{Voltage_{Reg}}{Voltage_{safety}} \quad (12)$$

$$Number_{PanelsParallel} = \frac{Current_{Reg}}{Current_{safety}} \quad (13)$$

Therefore applying all this data we get the maximum number amount of panels we can connect in series and parallel for the values of the charge regulators.

Voltage	Max.Num.Panels.Serie	Num.Panel.Serie
250	4,273504274	4
150	2,564102564	2
Current	Max.Num.Panels.Parall	Num.Panel.Parallel
85	7,188160677	7
100	8,456659619	8

**Table 10: Maximum number of panels series and parallel**



We have 52 panels to install, thus we know the amount of charge regulators we will need for every model:

$$Number_{Regulators} = \frac{52 \text{ Panels}}{Num.Panel_{Serie} * Num.Panel_{Parallel}} \quad (14)$$

Applying the upper equation we get the panels we will need:

Model	Num.Panel.Regulator	Num.Inverters
150/85	14	3,714285714
150/100	16	3,25
250/85	28	1,857142857
250/100	32	1,625

**Table 11: Number of charge regulators**

Looking at Table 11, we see that the models 250/85 and 250/100 are the ones that allow us to use the less amount of inverters, then we will choose the model 250/85 (cheaper than 250/100) and we will need two of them.

The connection scheme for the panels will be 28+24. One group of 28 panels and 24 panels are connected to a charge regulator. The regulators are connected in parallel to the battery system.

**SmartSolar Charge Controller 250/85**

<b>Battery Voltage</b>	12/24/48 V
<b>Rated charge current</b>	85 A
<b>Maximum PV open circuit voltage</b>	250 V
<b>Maximum efficiency</b>	99%

**Table 12: Charge regulator operative characteristics**

### 3.2. Inverter sizing

For the election of the inverter, we need to know the power that can be simultaneously connected from the consumption side. In order not to over-size the election of the amount of inverters needed, there is a criterion for considering how high the simultaneously connected power can be:

<b>Boiler</b>	2000W
<b>Fridge + Industrial Fridge</b>	900 W
<b>Electrical Stove</b>	2000 W
<b>Cleaning machine</b>	1000W
<b>Power socket</b>	3450 W* 0.5=1725 W
<b>Lights</b>	800 W*0.3*0.75=180W
<b>Total Simultaneous power:</b>	<b>7805 W</b>

**Table 13: Simultaneous connected power**

The factors applied are:

- **Power sockets:** A factor of use of 50% percent of the total power capability of the socket for one socket is considered. The unlikely scenario of all the consumptions connected at the same time justifies the application of this factor
- **Lights:** A factor of simultaneity of 30% for all the lights is applied. And a factor of use of 75% for power use for the lights.

$$Power_{SimultaneousSEC} = Power_{Simultaneous} * Factor_{Security} \quad (15)$$

**Factor<sub>Security</sub>** : is the same coefficient previously used for the charge regulator election, is a factor of 1.25 to secure the safety operation of the inverter.

$$Power_{SimultaneousSEC} = 7805 W * 1.25 = 9756.25 W$$

The inverter is also from the company **Victron Energy**, the one chosen is the model **Phoenix 48/5000**. Works at 48 V from the battery side and has a power output at 25°C of 5000VA. The output is a sinusoidal wave of 230 V to feed the consumptions.

$$Number_{Inverters} = \frac{Power_{SimultaneousSEC}}{Power_{inverter}} = \frac{9756.25}{5000} = 1.95125 \approx 2 Inverters$$

As the simultaneous connected power can be very high, we chose the biggest inverter **Victron Energy**, it is the one that allows us to only use two of them, with the rest we will need more than 2 inverters.

#### 4. Connection between lines

The connection cables that will be defined in this section will be the following ones:

- Solar panels-Combiner box
- Combiner box-Charge regulator
- Charge regulator-Battery system
- Battery system- Inverter
- Inverter- Consumption

Cables for the wind turbine:

- Wind turbine- turbine charge regulator
- Turbine charge regulator- Battery system

To size the connection between the different elements, the maximum current that could flow through the conductor (it means if the conductor is physically able to conduct the current without burning) and the voltage drop along the line will be taken into account.

The cables used for this sizing are the ones from the **Prysmian**'s catalog for photovoltaic installation, **TECSUN (PV) PV1-F**. The catalog disposes of a series of colors: Red, blue and black. The insulation cover of the cables is **HEPR 120° C**, cables at a rated voltage of **0.6/1 kv**.

The color helps with the installation process, red and blue will be used for the positive and negative on the solar panels strings respectively, for the rest of the installation red and black cables will be used for positive and negative.

The suggested installation method for all cables will be on a tube with two pairs of cables inside, named installation **type B1** for the outside line and **type F** for inside ones by the Spanish norm **UNE 20460-5-523**[31]. These methods are just suggested and not definitive, it is used to give a better and more real view on how the installation will behave. Maximum tolerated current for each cable section will be taken from the **table A.52-1 bis** which is from the previous normative.

The equations used to calculate the cable section needed in function of the voltage drop is the following:

For single-phase and direct current:

$$S (mm) = \frac{2*L*I}{c*(V_a-V_b)} \quad (16)$$

For single-phase and alternating current:

$$S(mm) = \frac{2*L*P}{c*e*V^2} \quad (17)$$

- **L**: the length of the conductor itself in meters.
- **I**: the current circulating through the cable in Amperes.
- **P**: the power transported on the line in Watts.
- **C**: electrical conductance of copper. At 20° C being 56 m/Ω\*mm<sup>2</sup>
- **V<sub>a</sub>**: the voltage at the beginning point of the conductor in Volts.
- **V<sub>b</sub>**: the voltage at the end of the conductor in Volts.
- **E**: the voltage drop of the line, is a non-dimensional parameter.
- **V**: the voltage at the alternating current line between a phase and the neutral, which is 230 V.

The maximums and recommended voltage drops used in this case study are the ones considered in the Spanish legislation (IDAE) [32]

Voltage drop (%)	Allowed value (REBT)	Recommended Value
Solar panels-Charge regulator/Inverter	3 %	1%
Charge regulator-Battery system	1%	0.5%
Battery system-Inverter	1 %	1%
Inverter-Light points	3%	3%
Inverter- Appliances	5%	3%

**Table 14: Voltage drop values. Source: IDAE**

First, let's start the selection of the proper conductors for the DC<sup>20</sup> part of the installation, which starts from the solar panels and ends at the inverter:

---

<sup>20</sup> Direct current

- **DC part of the installation:**

**Line Panels-Combiner box and line from combiner box-Regulator:**

The selectivity of the cables for the panel-combiner box and the junction box-regulator will be so the total voltage drop of both lines is within the range of the ones established in Table 14.

$$Voltage\ drop_{PanelRegulator} = Voltage\ drop_{PanelCombiner} + Voltage\ drop_{CombinerboxRegulator} < 1\% = 0.01 \quad (18)$$

The section of the conductor for the Solar panel-Combiner line will depend mostly on the distance from the positive pole of the panel to the combiner as all panels are arranged in strings of the same amount of panels 4

The minimum conductor's width will be of **6 mm<sup>2</sup>** on the DC to lower the voltage drop on that part because the voltage lowers the losses, which are higher due to joule effect (higher current). On the other hand, the installation process is easier.

Voltage drop of the string-panels to combiner						
N.Strings	Distance (m)		Cable width (mm)	Current string (A)	Voltage drop (%)	
	minimum	maximum				
1	1	5	6	9	0,00035468	0,00177342
1	5	9	6	9	0,00177342	0,00319215
1	9	13	6	9	0,00319215	0,00461089
1	3,53	7,53	6	9	0,00125203	0,00267077
1	7,53	11,53	6	9	0,00267077	0,0040895
1	11,53	15,53	6	9	0,0040895	0,00550824
1	1	5	6	9	0,00035468	0,00177342
1	5	9	6	9	0,00177342	0,00319215
1	9	13	6	9	0,00319215	0,00461089
1	3,53	7,53	6	9	0,00125203	0,00267077
1	7,53	11,53	6	9	0,00267077	0,0040895
2	11,53	15,53	6	9	0,0040895	0,00550824

**Table 15: Voltage drop at solar strings. Source: Own.**

In Table 15 we can see the voltage drops for the different strings. The red color symbolizes the positive cable of each string and the blue one the negative one. The length of every cable changes depending on the string position on the roof.

Considering that the combiner box for each group of panels will be installed at a maximum distance of **1 m** (the closest possibly). The distances between the negative (blue) and positive (red) will be of **4 m** which is the width of 4 panels in series:

$$Distance_{NegativePositive} = Width_{panel} * 4 \quad (19)$$

**Width panel:** Taken from the manufacturer datasheet **0.996 m**

$$Distance_{NegativePositive} = 0.996 * 4 = 3.984 \text{ m} \approx 4 \text{ m}$$

The distance between superior lines of panels will be the minimum distance of 1 m plus the minimum distance we will need to leave to avoid shadowing (check **Distance between panels on roof installation** for more information)

$$Distance_{UpperPanels} = MinimumDistance + Distance_{AvoidShadowing} \quad (20)$$

**Minimum distance:** The distance to the group's combiner. The minimum distance is **1 m**.

**Distance<sub>AvoidShadowing</sub>:** The distance to avoid shadowing. Calculated as **2.53 m**.

$$Distance_{UpperPanels} = 1 + 2.53 = 3.53 \text{ m}$$

The current is the highest one on normal use, that is the **Imp** (current at maximum output at STC<sup>21</sup>) of the solar panel (check annex for **TM-M672320** datasheet)

Now it is needed to check that the selected diameter of cable is able to support the short-circuit of the string, that will be the maximum current that can be tolerated on normal operation process.

Cable section (mm <sup>2</sup> )	Maximum tolerated current for under tube installation (A)*	Maximum expected current (A)
6	46	9.62

**Table 16: Thermic criterion for the selected cables. Source: Own**

\*The maximum tolerated current of the conductor is the one considered for an under tube installation for the selected sections (type B1 installation taken from table 52-B1/A.52-1 bis 40° C, insulator XLPE 2[31]).

Now let's see the line Combiner box-Regulator:

Group	Cables combiner to regulator				
	Lenght (m)	Current (A)	Conductor mm	Volt.drop	V.drop Panel-Combiner
1	12	54	35	0,00437781	0,009886049
2	12	63	35	0,00510745	0,010615684

**Table 17: Voltage drop from the combiners to the charge regulators. Source: Own**

<sup>21</sup> Standard Conditions

Considering that the Combiner box is installed at a maximum of **1 m** away from both groups of the panels. We obtain at

Group	Cables combiner to regulator				
	Lenght (m)	Current (A)	Conductor mm	Volt.drop	V.drop Panel-Combiner
1	12	54	35	0,00437781	0,009886049
2	12	63	35	0,00510745	0,010615684

Table 17 the voltage drop on the line and the sum of voltage drop from the panels (the worst scenario, when the string is with the highest voltage drop) to the junction box.

Thermic criterion for the combiner box-regulator line:

Group	Nominal current (A)	Conductor (mm)	Maximum tolerated current (A)*
1	54	35	137
2	63	35	137

**Table 18: Maximum current for the line combine-regulator**

\*Current corrected for the suggested installation method **B1**.

We can see that the chosen section is able to withstand the nominal operation of the line.

Being the total voltage drop for the compound line solar panel-regulator, the sum of the line with the highest voltage drop, plus the voltage drop for the cable from the combiner to the charge regulator.

Where:

$$Voltage\ drop_{PanelRegulator} = Voltage\ drop_{PanelCombiner} + Voltage\ drop_{CombinerboxRegulator} < 1\% = 0.01 \quad (18)$$

For **group 1**  $Voltage\ drop_{PanelsToRegulator} = 0.00550824 + 0.004377 = 0,009886049$

For **group 2**  $Voltage\ drop_{PanelsToRegulator} = 0.00550824 + 0.0051 = 0,010615684$

The voltage drop for the total line are within the ranges of **1%** as the recommended voltage drop. To easier the installation process all solar panels cables will be the same section,

therefore all cables will be **6 mm<sup>2</sup>** on the solar panels to combiner side. For the line from the combiner box to the charge regulator, the chosen section is **35 mm<sup>2</sup>**.

	N.strings	Total cable length (m)
<b>Group 1</b>	1	6
	1	14
	1	22
	1	11,06
	1	19,06
	1	27,06
<b>Group 2</b>	1	6
	1	14
	1	22
	1	11,06
	1	19,06
	2	27,06
Total:		198,36*2 cables= <b>396.72</b>

**Table 19: Total meters needed for section 6 mm<sup>2</sup>**

Group	Total cable length (m)
<b>1</b>	12* 2 cables
<b>2</b>	12* 2 cables
Total:	<b>48</b>

**Table 20: Total meters needed for section 35 mm<sup>2</sup>**

### Line charge regulator- battery system:

The highest power that the line connecting the charge regulators with the battery system will be the one coming from the solar panel system. The maximum PV<sup>22</sup> power output for 48V of the model **SmartSolar 250/85**, is 4900W (taken from the datasheet).

Therefore considering that there are 2 charge controllers in parallel the total maximum power coming from the PV to the battery system will be **9800 W**. Remind that the chosen system's voltage for the battery, regulator and inverter is **48 V**.

$$\text{For each regulator line } I_{max_{perRegulatorBattery}} = \frac{4900 \text{ W}}{48 \text{ V}} = 102.08 \text{ A}$$

Where the maximum distance is considered for the installation from the charge regulators to the battery system is **2 m**:

<sup>22</sup> PV: Photovoltaic



Cable regulator-battery				
Power (W)	Lenght (m)	Current (A)	Section (mm)	Voltage drop
4900	2	102,083333	35	0,004340278

**Table 21: Voltage drop for the line connecting the charge regulator with the battery system. Source: Own**

Let's check if the cable can withstand the current:

Nominal current (A)	Section (mm)	Maximum tolerated current (A)*
102.0833	35	174

**Table 22: Maximum tolerated current for the line regulator-battery system**

\*For the installation method F.

We can see that the chosen section of **35 mm** is able to withstand the current.

The voltage drop at the connection regulator-battery is lower than the recommended value of **0.5%**. The selected conductor diameter is of **35 mm<sup>2</sup>**.

	<b>Total cable length (m)</b>
<b>Connection charge regulator-battery system</b>	2*2 pair of cables
	<b>Total: 8</b>

**Table 23: Total meters needed for section 35 mm<sup>2</sup>**

### Line battery system to inverters:

The maximum power it will support is from the maximum simultaneous connected power from the power consumes (see Inverter sizing for more information about the criteria followed for calculating the maximum simultaneous connected power).

$$Power_{SimultaneousSEC} = 9756.25 W$$

$$I_{max_{BatteryInverter}} = \frac{9756.25 W}{48 V} = 203.55 A$$

The maximum recommend distance from the battery system to the inverters **2 m**.

Cable battery- Inverter				
Power (W)	Lenght (m)	Current (A)	Section (mm)	Voltage drop
9756,25	2	203,255208	35	0,008641803

**Table 24: Voltage drop from battery system to inverters. Source: Own**

The voltage drop falls right within the recommended value from Table 14.

But examining the thermic criteria for the cable we can see that it is not able to withstand the current that will pass through it, so we need to take a bigger cable section.

Nominal current (A)	Section (mm)	Maximum tolerated current (A)*
203.255	35	174

**Table 25: Tolerated current for 35 mm cable cross section**

\*Type F installation

It can be clearly seen that the cable is not capable of handling the nominal current for the line. A new section of **70 mm** is chosen.

Section (mm)	Nominal current (A)	Maximum tolerated current (A)*
70	203.255	269

**Table 26: New section maximum current values.**

\*Type F installation

The voltage drop for the new conductor line section is:

Cable battery- Inverter				
Power (W)	Lenght (m)	Current (A)	Section (mm)	Voltage drop
9756,25	2	203,255208	70	0,004320902

**Table 27: Voltage drop for 70 mm section.**

Where we can see that the voltage drop values are within the recommended ones, lower than 1 %. Therefore the definitive cable section will be of **70 mm** for the battery-inverter line.

	Total lenght (m)
Battery-Inverter	2* 2 cables
Total:	4

**Table 28: Total length needed for 70 mm<sup>2</sup>**

- **AC part of the installation:**

#### **Line Inverter to distribution panel:**

The installation of distribution panel from where the two branches will emerge, one goes to the production area to feed the boiler and industrial fridge and the other one goes to feed the house consumptions. The distribution panel locates the protection of the lines, as well, and is located at a maximum of **1 m** from the inverter.

The section needed for the connection inverter will be the minimum that can support the current, considering that previously was stated that the minimum recommended section is of **6 mm**:

Power (W)	Nominal current (A)	Max tolerated current cable (A)*	Lenght (m)	Section (mm)	Volt. Drop
9756,25	42,41847826	46	1	6	0,00109779

**Table 29: Line inverter to distribution panel. Source: Own**

We can see that the section **6 mm<sup>2</sup>** is able to support the current, so there is no need to oversize it more.

#### **Line distribution panel to consumption:**

For this part two lines are needed to be sized:

- Line to the production area

- Line to the house

The maximum recommended voltage drop for both lines is **3%** of a phase-neutral voltage of **230V**. The distances to the production area and the house from the small house, where the inverters are located, is of **50 m** and **14 m** respectively.

The section takes into the account the previous data and the following formula is used  $S(mm) = \frac{2 * L * P}{c * e * V^2}$  (17) :

For the production part:

$$S(mm) = \frac{2 * 50 * 2750}{56 * 0.03 * 230^2} = 3.094 \text{ mm}$$

Where:

**P**: The power of the boiler plus the industrial fridge, which is **2750 W**.

For the house part:

$$S(mm) = \frac{2 * 14 * 7006}{56 * 0.03 * 230^2} = 2.207 \text{ mm}$$

Where:

**P**: Is the power from the previously calculated maximum simultaneous connected power minus the power from the production part, that is: **P= 9756 W-2750 W= 7006 W**

At **TECSUN-PV-PV1-F** catalogue we can see that the closest cross sections are **4 mm** and **2.5 mm** respectively. But the selected diameter for both of them will be **6 mm** to make the installation process easier. Therefore the voltage drops we obtain are:

	Section (mm)	Voltage drop
House	6	0,011036941
Production	6	0,01547169

**Table 30: Voltage drop on the consumes.**

We can see that the voltage drops are well within the tolerated values for both cases. Lastly we need to see if the selected cables are able to withstand the maximum nominal current, considering that they are installed under tube (Type **B1** installation [31]):

Line	Section (mm)	Nominal current (A)	Maximum tolerated current (A)*

<b>House</b>	6	30.46	46
<b>Production</b>	6	11.956	46

**Table 31: Maximum current for AC consume lines**

\*Type **B1** installation

We see in Table 31 that they are able to withstand it. Therefore the selected section will be **6 mm**.

	<b>Length needed (m)</b>
<b>Inverter-Distribution</b>	1
<b>House</b>	14
<b>Production area</b>	50
	Total: 65* 2 cables= 130

**Table 32: Total length needed from distribution to consumption.**

- **Wind turbine line sizing:**

The maximum power output from the wind turbine is maximum **3000W**, the working voltage of the turbine is of **48V**.

The allowed and recommended voltage drops for the wind turbine line connection are the same of that previously stated for the solar panel.

**Line from wind turbine to charge regulator:**

As we stated in the final solution description, the wind turbine should be installed around **10 m** away from the house, then considering that the charge regulator of the turbine will be installed where the other charge controllers are (the ones from the PV system) a total distance of **20 m** from the turbine to the regulator can be considered.

<b>Wind turbine to Charge regulator</b>					
<b>Power (W)</b>	<b>Voltage</b>	<b>Current (A)</b>	<b>Section(mm)</b>	<b>Length (m)</b>	<b>Voltage drop</b>
3000	48	62,5	95	20	0,0097901

**Table 33: Voltage drop for the Wind turbine-Regulator line.**

For a **95 mm** size cable the voltage drop is right within the recommended value, lower than **1%** total drop. Now let's see if the cable supports the nominal current along the cable:

<b>Nominal current (A)</b>	<b>Maximum tolerated current (A)*</b>
62.5	327

\*Type F installation

It can be clearly seen that the cable is able to withstand the current.

**Line from charge regulator of the wind turbine to battery system:**

Where the voltage drop will be, considering that the charge controller is installed at a maximum of **2 m** from the battery system.

Charge regulator to battery system					
Power (W)	Voltage	Current (A)	Section(mm)	Length (m)	Voltage drop
3000	48	62,5	25	2	0,003720238

**Table 34: Voltage drop from the regulator to the battery system.**

The maximum tolerated current from the cable will be:

Nominal current (A)	Maximum tolerated current (A)*
62.5	140

**Table 35: Tolerated current for the cable charge regulator of the turbine to the battery system.**

The total amount needed of cable will be of:

	Length needed (m)
Turbine-regulator	20
Total:	20*2 cables=40

**Table 36: Total length needed of section 95 mm.**

	Length needed (m)
TurbRegulator-Batt	2
Total:	2*2 cables=4

**Table 37: Total length needed for section 25 mm.**

## 5. Protections

### 5.1. Fuses

The chosen fuses are **gPV** fuses by the company **SOCOMEK**, that is constructed according to **IEC 60269 standard**. With a rated breaking voltage of **1000 VDC** for the models from **1 to 600 A** (taken from the fuse datasheet).

For the selection of the correct nominal current for the fuse it is needed to introduce the following equations:

For the protection of the cable system the fuse must meet the following criteria:

$$I_b \leq I_n \leq I_z \quad (21)$$

$$I_2 \leq 1.45 * I_z \quad (22)$$

Where:

**I<sub>b</sub>**: The design current for the circuit

**I<sub>n</sub>**: The the nominal current assigned to the protection device. Caliber.

**I<sub>z</sub>**: The maximum tolerated current by the conductor.

**I<sub>2</sub>**: The current where the activation of the device is guaranteed. For fuses made following the **IEC 60269** norm, the guaranteed activation current is **I<sub>2</sub>=1.6\*I<sub>n</sub>**.

The short-circuit current along the lines must be calculated to see if the fuse device is able to protect against the short circuit currents:

$$I_{SC} = \frac{\text{Voltage at that line part}}{\Sigma \text{Resistances}} \quad (23)$$

$$\text{Breaking Capacity} > I_{scmax} \quad (24)$$

$$I_{scmin} > I_a = I_{f5} \quad (25)$$

Where:

**I<sub>scmax</sub>**: The maximum short-circuit current expected on the line.

**I<sub>scmin</sub>**: The minimum short-circuit current expected on the line.

**Ia:** The current point is when the I/t graphic for the cable and fuse device cut. The mentioned graphic is not available, the  $I_{15}$  current at which, after 5 seconds pass, the fuse opens, will be taken.

The short-circuit currents along the circuit depend on the short-circuit coming from the solar panels. A security factor will be defined to oversize the short-circuit and to make sure that it protects the cable even the currents are lower in practice.

**Factor<sub>security</sub>:** 1.25

For circuit breakers the following equations must be accomplished:

$$\text{Breaking capacity} > I_{scmax} \quad (26)$$

$$I_{scmin} > I_a \quad (27)$$

$$I_{scmax} < I_b \quad (28)$$

Where:

**Ia:** The current of activation of the magnetic device.

**Ib:** The current that corresponds to the value  $(I^2t)_{adm}$  of the conductor line measured on the circuit breaker graphic for  $(I^2t)$ . The tolerable value for the conductor is:

$$(I^2 * t)_{Maxcable} = k^2 * S^2 \quad (29)$$

Let's choose the fuses for the system:

- **PV string to combiner fuse:**

We know that the strings of the panels are formed of 4 panels connected in series. The connection lines of all panels to the combiner are **6 mm** cross section.

Nominal current (A)	Current rating of fuse	Maximum tolerated current (A)*
9.46	12	46

**Table 38: Fuse string to combiner**

\*For the suggested installation method **B1**

Where:

$$9.42 < 12 < 46 \quad \text{Valid}$$

$$I_2 = 1.6 * 12 = 19.2 \text{ A}$$

And:



$$1.45 * I_z = 66.7 \geq I_2 = 19.2 \text{ Valid}$$

The short-circuit currents of the chosen panel looking at **Tamesol** datasheet for the model is **TM-M672340**:

**Isc**: 9.46 A

The fuse should not cut the line when the string is on short-circuit mode, so as we see in Table 38 the **Isc** was considered the design current for the line.

The fuse should cut the line in the situation when the strings of panels connected in parallel starts to feed the string (in case of fault at that string), instead of supplying the consumption.

	N.Voltage (V)	Rpanel	Isc (A)	LineLength (m)	Section (mm)	pCopper	R.Panel-Combiner
<b>String</b>	151,04	15,9661734	9,46	15,53	6	0,02	0,04622024

**Table 39: String and line short-circuit characteristics**

Where:

**N.voltage**: The total voltage of 4 panels connected in series. In volts.

**Rpanel**: Which is the internal resistance of the panel at short-circuit instant.

$$R_{panel} = \frac{N. \text{ voltage}}{I_{sc}} = \frac{151.04}{9.46} = 15.966 \Omega$$

**LineLength**: The longest line installed for the different strings. Where in this case is **15.53 m**, which is the farthest string.

**pCopper**: The conductance of copper at 20°C temperature. In  $\Omega \cdot \text{mm}^2/\text{m}$ .

**R.Panel-combiner**: The resistance of the line connecting to the farthest string to the combiner. The following equation is used:

$$Resistance = \rho_{copper} * \frac{L}{Section} \quad (30)$$

Then the short-circuit for each group will differ considering the worst case scenario, for **Group 1** the fuse should protect the line of one string in case of 5 other strings short-circuited to it.

For **Group 2** the worst case scenario is 6 strings short-circuit to a single string. The total short-circuit current form each group will be:

$$Isc_{group} = (N - 1) * Isc * Factor_{security} \quad (31)$$

Then:

<b>R5panels</b>	3,19323467 $\Omega$	<b>R6panels</b>	2,66102889 $\Omega$
<b>Group 1</b>		<b>Group 2</b>	
<b>Iscmax</b>	<b>Iscmin</b>	<b>Iscmax</b>	<b>Iscmin</b>
59,125	58,2814101	70,95	69,7386871

**Table 40: Short current for the farthest string on each group.**

The chosen fuse has a breaking capability of **30 kA** and a **If5** of **30 A**.

For group 1:

$$30000 \text{ A} \gg Iscmax = 59.125 \text{ A} \text{ Valid}$$

$$Iscmin = 58.2814 > If5 = 30 \text{ A} \text{ Valid}$$

For group 2:

$$30000 \text{ A} \gg Iscmax = 70.95 \text{ A} \text{ Valid}$$

$$Iscmin = 69.738 > If5 = 30 \text{ A} \text{ Valid}$$

- **Lines combiner box to regulator fuses:**

The short-circuit possibilities in this part of the installation is that of short-circuit current to each array through the line connecting the combiner for each group and each group array regulator.

	<b>N.Voltage</b>	<b>Rarray</b>	<b>Isc</b>	<b>LineLenght</b>	<b>Section</b>	<b>pCopper</b>	<b>R.Comb-Reg</b>
<b>Group 1-Regulator</b>	151,04	2,66102889	56,76	12	35	0,02	0,006122449
	<b>N.Voltage</b>	<b>Rarray</b>	<b>Isc</b>	<b>LineLenght</b>	<b>Section</b>	<b>pCopper</b>	<b>R.Comb-Reg</b>
<b>Group 2-Regulator</b>	151,04	2,28088191	66,22	12	35	0,02	0,006122449

**Table 41: Line from combiner to junction box characteristics.**

Where the maximum expected short-circuit currents for both groups are the following:

<b>Group 1</b>		<b>Group 2</b>	
<b>Iccmax</b>	<b>Iccmin</b>	<b>Iccmax</b>	<b>Iccmin</b>
69,7386871	69,5813288	81,1309466	80,9180566

**Table 42: Maximum and minimum Isc for both group arrays.**

The chosen Fuse rating will be between the nominal current for each group **Isc** and the maximum tolerated current for the cable section of **35 mm**.

	Nominal current (A)	Fuse current rating (A)	Max tolerated current (A)*
<b>Group 1</b>	56.76	63	174
<b>Group 2</b>	66.22	80	174

**Table 43: Fuse rating line from combiner to regulator.**

\*Installation method type F

The activation fuse will activate at:

$$I_2 = 1.6 * 80 = 128 A \text{ and } I_2 = 1.6 * 63 = 100.8$$

$$1.45 * 174 = 252.3 A$$

We see that for **group 1**:

$$I_2 = 127A \leq 1.45 * I_z = 252.3 \text{ Valid}$$

And for **group 2** :

$$I_2 = 128 < 1.45 * I_z = 252.3 \text{ Valid}$$

The fuse can handle the maximum possible short-circuit, knowing that the chosen model are: two fuses of **63** and **80 A** rating and fuse size **NH1**.

Looking at

Group 1		Group 2	
lccmax	lccmin	lccmax	lccmin
69,7386871	69,5813288	81,1309466	80,9180566

Table 42 we get the **Isc**:

**Group 1**  $I_{scmax} = 81.13 A < \text{Breaking capacity} = 50000A$  Valid

$$I_{f5} = 225 A > I_{scmin} = 81.11 A \text{ Not valid}$$

**Group 2**  $I_{scmax} = 69.738 A < \text{Breaking capacity} = 50000A$  Valid

$$I_{f5} = 300 A > I_{scmin} = 69.72 A \text{ Not valid}$$

We can see that the fuses are capable of dealing with the maximum short-circuit currents due to the high breaking capability of the fuses, but they do not meet the second condition.

Although on other type of installation an addition protection measure should be installed to cover this weakness, in this case we see that the own conductor are capable of dealing with the **Iscmin** without passing the tolerance limit for the installation type suggested. So no extra protection is needed.

- **Line regulator to battery :**

Now for the lines connecting the two charge regulators to the battery system. The voltage changes to **48V** and so does the current. The maximum short-circuit what the line can suffer is when the battery system's reverse current circulates along the line in a short circuit between the line and the battery system.

	N.Voltage	Lenght	Section	Rreg-bat	Rtotalreg-bat
<b>Regulator-Battery</b>	48	2	35	0,00102041	0,000510204

**Table 44: Line from the regulators to battery characteristics.**

Where:

**Rtotalreg-bat:** Is the sum of both **Rreg-bat**, that is the resistance of the line of each of the two charge regulators to battery lines:

$$RTotal_{RegBat} = \frac{1}{\left(\frac{1}{R_{RegBat}} + \frac{1}{R_{RegBat}}\right)} \quad (32)$$

The **maximum short-circuit current** is the one that occurs at the union point of both lines from the charge regulators to the battery system.

The **minimum short-circuit current** is the one at the base of the charge regulator for each line, from the reverse current of the battery system.

	Regulator-Battery system			
	Psc	Inominal	Iscmax	Iscmin
<b>Group 1</b>	58080	102,083333	1512,5	1202,636917
<b>Group 2</b>	58080	102,083333	1512,5	1202,636917

**Table 45: Maximum and minimum short circuit currents.**

Where:

**Psc:** The Short-Circuit power output of the battery system:

$$Psc = VoltageBattery * Isc_{C1hour} * 10 \text{ batteries in parallel} = 48 * 121 * 10 = 58080 W$$

**Isc:** **Iscmax** with security factor and the **minimum Isc** without it.

$$Iscmax = Factor_{security} * \frac{Psc}{48 V} = 1.25 * 1210 = 1512.5 A$$

The chosen fuse for the two lines is the following:

Nominal current (A)	Fuse current rating(A)	Max tolerated current (A)*
102.08	125	174

**Table 46: Fuse caliber for the line from regulator to battery.**

\*Method F of installation

Where:

$$I_2 = 1.6 * In = 1.6 * 125 = 200 A$$

$$1.45 * Iz = 252.3 > I_2 \text{ Valid}$$

The short-circuit protection from the fuse:

$$\text{Breaking capacity} = 50000 A \gg Iscmax \text{ Valid}$$

$$If5 = 500A < Iscmin \text{ for both lines Valid}$$

- **Line from battery system to inverter:**

The union line between the battery system and the inverter presents the following characteristics:

	N.Voltage	Length (m)	Section (mm)	Rbat-inv
Battery-Inverter	48	2	70	0,00102041

**Table 47: Connection line between batteries and Inverter characteristics.**

Where the maximum and minimum **Isc** are the following:

Battery system-Inverter			
Psc	Inominal	Iscmax	Iscmin
58080	203,255208	1512,5	1208,77

**Table 48: Expected short-circuit currents at the line.**

The **Iscmin** is the one at inverter level and the **Iscmax** will be the one at battery level, where **Iscmax** has been calculated:

$$Iscmin = \frac{Psc}{(48 V * +R_{BatInv})}$$

The chosen fuse will be the following:

Nominal current (A)	Caliber of the fuse (A)	Maximum tolerated current (A)*
203.255	250	269

**Table 49: Fuse rating for the line battery-inverter.**

\*Type F installation

Where:

$$I_2 = 1.6 * 250 = 400 A$$

$$1.45 * I_z = 269 A < I_2 \text{ No Valid}$$

The protection against short-circuit:

$$I_{sc_{max}} \ll \text{Breaking capacity} = 33000 A \text{ Valid}$$

$$I_{f_5} = 800 A < I_{sc_{min}} \text{ Valid}$$

- **Line from Inverter to distribution panel fuse:**

Where :

Cable inverter-distribution panel					
Power (W)	Voltage	Inominal	Section (mm)	Length (m)	RInvDist
9756,25	230	42,4184783	6	1	0,00297619

**Table 50: Characteristics of the line from the Inverter to the distribution panel.**

The Isc are:

Psc	Voltage	Iscmax	Iscmin
58080	230	315,652174	314,7155206

**Table 51: Isc at the Inverter to distribution panel.**

Let's choose the needed fuse:

Nominal current (A)	Fuse current rating (A)	Max tolerated current (A)*
42.4184	50	57

**Table 52: Fuse rating**

\*For E type installation

Where:

$$I_2 = 1.6 * 50 = 80 A$$

$$1.45 * I_z = 82.65 > I_2 \text{ Valid}$$

Now the short circuit protection from the fuse:

$$I_{scmax} = 100.095 \ll \text{Breaking capacity} = 50000 A \text{ Valid}$$

$$I_{f5} = 150 A < I_{scmin} \text{ Valid}$$

Further protection from a circuit breaker is needed:

- **Lines from distribution panel to consumption:**

The characteristic of the lines going to the electrical consumptions are:

	Power	Length	Current	Section	ResistanceLine
<b>Home</b>	7006,25	14	30,4619565	6	0,04166667
	Power	Length	Current	Section	ResistanceLine
<b>Production</b>	2750	50	11,9565217	6	0,14880952

**Table 53: Lines from the distribution panels to the consumptions, characteristics.**

The short-circuit will be the one at the distribution panel, which is the **Iscmax**, and the minimum **Isc** at the end of the line due to the resistance of the line itself.

	Iscmax	Iscmin
<b>House</b>	314,715521	241,730212
<b>Production</b>	314,715521	219,24368

**Table 54: Isc in the consumption lines.**

Where the **Iscmax** is the one at the distribution panel level, and **Iscmin** is the one at the end of each line:

$$I_{scmin_{linesAC}} = \frac{P_{sc}}{(48 V * (1 + R_{InverterDist} + R_{Line}))}$$

Then the chosen fuse will be the following:

Nominal current (A)	Fuse rating (A)	Max tolerated current (A)*
30.46	32	46
11.95	15	46

\*Installation type **B1**

For the house the fuse rating of **32 A** fuse size is 14x51 and **15 A** fuse size is 10x38 for the production part.

$$I_{2house} = 1.6 * 32 = 51.2 A \text{ and } I_{2production} = 1.6 * 15 = 24 A$$

Then:

$$I_z * 1.45 = 66.7 A \text{ Valid for both of them}$$

The fuses have a breaking capacity of **30 kA** for the **15 A** rated fuse and **10kA** for the **32 A** one. So as we can see they are much higher than the **Iscmax** so they are valid.

On the other protection condition:

$$\text{For the production part } If_5 = 45 A < I_{scmin_{withoutsecurityfactor}} = 219.24 A \text{ Valid}$$

$$\text{For the house part } If_5 = 80 A < I_{scmin_{withoutsecurityfactor}} = 241.73 A \text{ Valid}$$

- **Line to the wind turbine protection**

The maximum tolerated currents for the battery system to turbine charge regulator and for the line from the charge regulator to the turbine are the reverse current of the short-circuit with the battery system:

Nominal current (A)	Fuse rating (A)	Max tolerated current (A)*
62.5	80	327*
62.5	80	140*

**Figure 37: Lines from battery system to wind turbine currents.**

\*Type F installation

$$I_2 = 1.6 * 80 = 128 A$$

$$I_z * 1.45 = 140 * 1.45 = 203 A > I_2 \text{ Valid for both lines}$$

Now the protection against short currents:

Wind turbine to Charge regulator					
Power (W)	Voltage	Current (A)	Section(mm)	Length (m)	ResistanceLine
3000	48	62,5	95	20	0,003759398
Charge regulator to battery system					
Power (W)	Voltage	Current (A)	Section(mm)	Length (m)	Resistanceline
3000	48	62,5	25	2	0,001428571

**Table 55: Lines from battery system to wind turbine characteristics.**



And:

Wind turbine to regulator			
Psc	Voltage	Iscmax	Iscmin
58080	48	1510,34237	1203,75496
Battery system to regulator			
Psc	Voltage	Iscmax	Iscmin
58080	48	1512,5	1208,27389

**Table 56: Expected Isc currents at the lines of the wind turbine.**

*Breakin capacity = 50000 A >> Iscmax Valid for both lines*

*If<sub>5</sub> = 300 A < 1023.75 A and < 1208.27 A Valid for both lines*

## 5.2. Grounding

The grounding should guarantee that the contact voltage when a defect occurs is of **24 V**, this in addition to the differential protection at the house and production area considering a sensibility of **30 mA** from the protections (following the Spanish legislation) .

$$R_{GroundingDC} = \frac{24 V}{0.03 A} = 800 \Omega$$

The grounding for the DC can be made through a TN-S connection to ease the installation. It will connect to the grounding the neutral and masses of the solar panel, the masses of the combiner boxes, wind turbine mass and its charge controller and the charge regulators for the PV system.

Let's see the sizing of a vertically disposed plate for the installation of the grounding:

$$R_{Grounding} = \frac{0.8 \cdot \rho}{L} \quad (33)$$

**P:** The resistivity of the terrain. For this case a farming terrain not to humid, the parameter will be **10 Ωm**

**L:** The perimeter of the plate.

$$L = \frac{150 \cdot 0.8}{800} = 0.15 \text{ m}$$

The plate is 2 mm wide.

## 6. Others

### 6.1. Selection of solar panel model

The selection of panels will be between a series of panels considered to be installed. The models considered are the following by the manufacturer companies:

#### Tamesol:

Three models from the family **TM-M672** 320, 325 and 340 W

#### AE Solar GmbH:

Two models: **AE305P6-72** of 305 W and **AE310P6-72** power output 310 W

The prices for the solar panels are taken from **Enfsolar**'s database [33]

Power to install (W)	Panel model	Price of panel (€/Wp)	Power panel	Monthly irradiation (Wh/m <sup>2</sup> )	Panels needed	Price (€)
33401,3822	TM-M672320	0,378	320	1910	55	6.652,80 €
33401,3822	TM-M672325	0,378	325	1910	54	6.633,90 €
33401,3822	TM-M672340	0,378	340	1910	52	6.683,04 €
33401,3822	AE305P6-72	0,39	305	1910	58	6.899,10 €
33401,3822	AE310P6-72	0,39	310	1910	57	6.891,30 €

**Table 57: The comparison of solar panels. Source: Own**

In Table 57 we can see the difference in price among the different models. We can reject the models from the **AE Solar GmbH** company, since they are more expensive than the ones from the **Tamesol** family of monocrystalline.

Selecting between the three types of panels from the same family is not just about money, we have to take into account that the amount of the panels are pretty high, the difference in price

among the three of them are pretty low, that the model that needs the least amount of panels to supply the needed power is also preferable (due that the installation will be on the roof).

But the definitive factor for selecting the panel model is the amount of charge controllers depending on how we organize them.

The considered charge regulators as we established before are the models **SmartSolar 250/100**, **250/85**, **150/100** and **150/85**. For more information about the calculation process see Charge regulator.

	Panel parameters		Regulator characteristics							
	Vosc	Icc	Voltage		Current		Series		Parallel	
TM-M672320	46,62	8,94	250	150	85	100	4	2	7	8
TM-M672325	46,67	9,07	250	150	85	100	4	2	7	8
TM-M672340	46,8	9,46	250	150	85	100	4	2	7	8

**Table 58: Number of panels in parallel and series by charge regulator. Source: Own.**

In Table 58 we see that the regulator allows the same amount of panels in parallel and series connection for the three types of panels, dividing the maximum amount of panels each regulator can take, thus we obtain the number of regulators needed:

Amount of Regulators					
Number panels	250/100	250/85	150/100	150/85	
55	1,71875	1,96428571	3,4375	3,92857143	TM-M672320
54	1,6875	1,92857143	3,375	3,85714286	TM-M672325
52	1,625	1,85714286	3,25	3,71428571	TM-M672340

**Table 59: Amount of regulators needed by solar panel model. Source: Own**

Watching Table 59 we would select the model **TM-M672325** as it is the cheapest one, and needed two **SmartSolar 250/85** as the other two but the problems comes when organizing the panels **TM-M672320** and **TM-M672325** due that the number of panels needed for each model is 55 and 54 respectively.

The problem is that we cannot organize the numbers 55 and 54 in combinations that give an integer number using only two regulators with the proposed models: e.g for the 55 panels group.

Possible combinations would be 32+23, 31+24, 30+25 and 29+28 doing the basic math of dividing the previous numbers between the maximum allowed of panels possible in series by each charge regulator we can see we never get an integer number.

So if we choose those two models we would need three charge regulators even it sounds unintuitive.

But the model **TM-M672340**, which needs 52 can be organized in two groups of 28+24 that can use only two regulators, which is the cheapest solution. Therefore the chosen model for the installation is the model **TM-M672340** of 340 W.

### 7. Distance between panels on roof installation

Although normally on roof installation the solar panels are installed at the same angle as the roof, and there is no separation between panels is needed, in this case the panels are suggested to be installed at a  $50^\circ$  degree angle, which is  $5^\circ$  more than the roof angle of around  $40-45^\circ$ . Then a separation is needed between the panels to avoid shadowing.

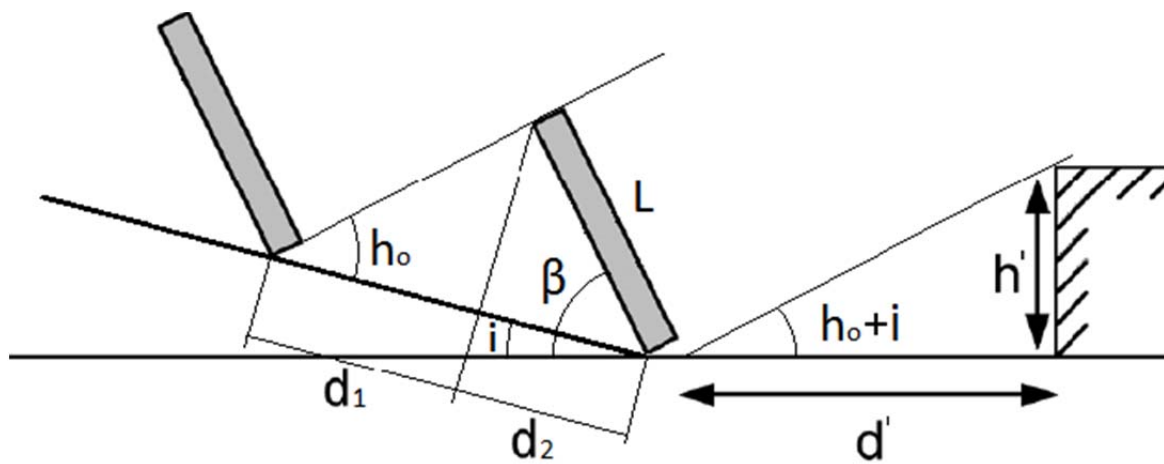

**Figure 38: Distance to avoid shadowing in inclined installation. Source: IDAE[32]**

The following calculation process:

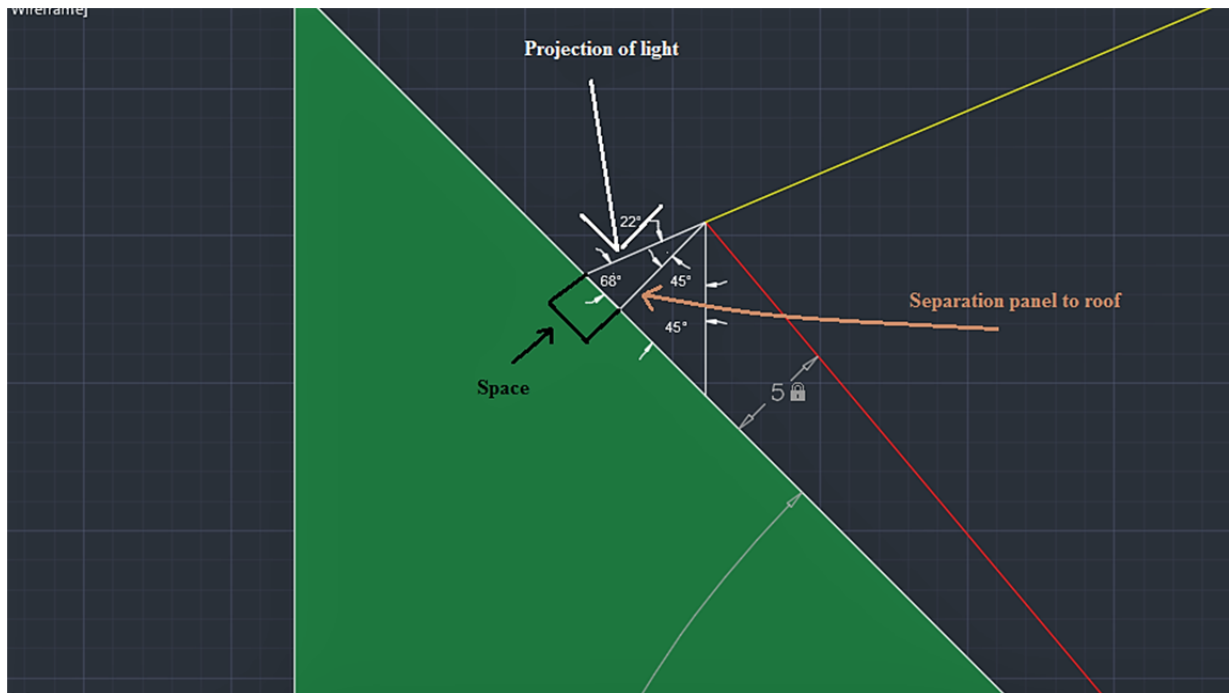

**Figure 39: Light projection in winter on the panels. Source: Own creation**

The explanation of Figure 39:

**Yellow line:** Represents the sunlight in winter (the worst scenario) where the light presents a 23° angle with the ground (horizontal axis).

**Red line:** Represents the solar panel. The chosen model is 1,956 m long. The panel is at a 5° degree with the roof surface and at a 50° angle with the horizontal axis.

**Projection of Light (PL):** The distance that the light travels since it “touches” the solar panel and ends at the roof surface.

**Space (d):** The minimum distance to separate the upper panel to avoid shadowing.

**Separation panel to roof (SPR):** The vertical distance of the highest part of the solar panel in respect to the local axis located on the roof surface.

The calculation of the minimum space needed will be as follows:

$$SPR = Panel_{Length} * \sin PanelToSurface \text{ (mm)} \quad (34)$$

Being:

**PanelToSurface:** The angle between the panel and the surface is 5°.

**PanelLength:** 1956 mm

$$SPR = 1956 * \sin 5^\circ = 170.47 \text{ mm}$$

We calculate now the previously stated Projection of the light:

$$PL = \frac{SPR}{\sin 68^\circ} \text{ (mm)} \quad (35)$$

$$PL = \frac{170.47}{\sin 68^\circ} = 183.857 \text{ mm}$$

Now to finish the minimum space needed to be left between the solar panels :

$$Space = PL * \cos 68^\circ \quad (36)$$

$$Space = 183.857 * \cos 68^\circ = 68.874 \text{ mm} \approx 70 \text{ mm}$$

The angle of the roof is between 45 to 40 degrees. Therefore the minimum space needed should be bigger for safety reasons.

Then the total space measured from the base of the first line of panels is:

$$Space_{total} = Space + Panel_{lengthsurface} \quad (37)$$

Being  $Panel_{lengthsurface}$ : The projection of the first line of panels' length upon the roof surface:

$$Panel_{lengthsurface} = Panel_{length} * \cos(Angle_{panel} - Angle_{Roof}) \quad (38)$$

$$Panel_{lengthsurface} = 1956 \text{ mm} * \cos(50^\circ - 45^\circ) = 1948.55 \text{ mm}$$

$$Space_{total} = 70 \text{ mm} + 1948.55 \text{ mm} = 2018.55 \text{ mm}$$

Then:

$$Space_{totalSecurity} = Space_{total} * Factor_{Security} \quad (39)$$

**Factor<sub>Security</sub>** = 1.25

$$Space_{totalSecurity} = 2018.55 \text{ mm} * 1.25 = 2523.19 \text{ mm} \approx 2523 \text{ mm} = 2.523 \text{ m}$$



**Compilation of case studies of applying renewable energies to local  
development transnationally implemented**



Co-funded by the  
Erasmus+ Programme  
of the European Union





# Budget and economic analysis





**Compilation of case studies of applying renewable energies to local development transnationally implemented**



Co-funded by the  
Erasmus+ Programme  
of the European Union



## 8. Economical aspects of the project

On previous chapters of this case study we defined the total amount of needed elements for the hybrid installation, being the amount of elements needed for the installation:

<b>TM- M672340</b>	52 Panels
<b>Enair E30PRO 48V</b>	1 turbine + regulator
<b>SmartSolar 250/85</b>	2 charge regulators
<b>Phoenix 48/5000</b>	2 inverters in parallel
<b>Batteries 12CS-11PS</b>	40 blocks

**Table 60: Elements to install at the hybrid system.**

For the different calculations we will do in this chapter, the following parameters are needed to be defined:

**Discount Rate:** The gain or loss on an investment over a specified time period, expressed as a percentage of the investment's cost. For this case a discount rate of **5%** has been taken

**O&M:** Being the maintenance and operation of the system. For off-grid systems the annual O&M of **2%-6%** of the initial capital cost is taken , for this case study a rate of **2%** .

**Investment period:** The period of time taken into consideration when calculating the NPV and IRR of the investment. A period of 20 years has been taken.

### 8.1. Budget of the installation

The cost of the elements inTable 60 will be :

	<b>Price.exVAT(€)</b>	<b>PriceVAT(€)</b>
<b>Panels</b>	6.683,04 €	7.952,82 €
<b>Wind turbine</b>	5.880,16 €	6.997,39 €
<b>Inverters</b>	5.086,00 €	6.052,34 €
<b>Charge regulators</b>	1.413,45 €	1.682,00 €
<b>Battery system</b>	37.830,08 €	45.017,80 €
<b>Total price:</b>		<b>67.702,35 €</b>

**Table 61: Price with VAT of the system elements.**

As we can see in off-grid systems the need of battery systems hugely increments the price. Now for the **Balance of System (BOS)** investment, that the price includes:

Mounting system, installation, cables, infrastructure, transformer, grid connection, planning and documentation and any other elements.

For the off-grid system the transformer and grid connection will not form the part of the investment, as they are not needed. So taken data from ground-mounted PV systems in Germany [34] the cost for mounting is of **75 €/Kwp**, Installation and DC-cabling costs are around **50 €/Kwp** and infrastructure is **40€/Kwp**. Finally the compound cost of transformer, switchgear and planning is of **60€/Kwp**, so the price for planning and documentation is of **20€/Kwp**.

Engineering and construction is around **370 Euros/Kwp** and Fees and permitting, are around **160 €/Kwp**

Considering the wind turbine as part of the installed photovoltaic system we get that:

Installed power (kW)	Price/Kwp (€/Kwp)	Price (€)
20.68	715	14786

**Table 62: BOS and additional cost.**

A funding for the installation can be asked from the funding program **Casa verde** (Green house in English) for a total of 6000 Lei (**1500 €**) funding.

The total initial investment will be:

Elements price	BOS+ others	Funding	Total (€)
67702.35	14786	-1500	80988.35

**Table 63: Total initial investment**

The yearly **O&M** cost is: **1619.767 €**.

Comparing the renewable solution to the standard connection to the electrical grid, it can be seen:

The distance between the closest connection point to the medium voltage (MV) network is 2 km far away (this distance is only the horizontal distance, not the upwards distance, due that the farm is located on a higher position respect to the closest population core)

The prices for a typical connection from an MV network, considering that the infrastructure required to connect the farm to the network is not installed:

- From MV to the location: **57900 €/km**
- The price of the transformer from 20/0.4 Kv, 63kVA: **10500 €/Piece**

Prices were given by **E·ON** company responsible of the installation of the electrical infrastructure in the area, the partner of **General Electric**. The prices are just estimated, and probably in the case scenario where the traditional grid connection was chosen, the price could be higher due to the difficulties on the whole line installation along the area (uphill, forest, mud etc...)

Therefore the initial investment from the connection to the normal grid will be a total of:

$$TotalPrice_{StandardConnection} = 2 \text{ km} * 57900 \frac{\text{€}}{\text{km}} + 10500 \frac{\text{€}}{\text{piece}} = \mathbf{126300 \text{ €}}$$

We can see that the price is higher than the proposed installation for this case study.

## 8.2. Payback, IRR and NPV

The payback from the installation is calculated with the following formula:

$$Payback \text{ period} = \frac{Initial \text{ investment}}{Annual \text{ cash flows}} \quad (40)$$

Where the annual cash flows will be from the saving from not used diesel generator:

$$CashFlow = LitresDieselSaved * PriceDiesel - O\&M \quad (41)$$

Where the yearly litres of diesel saved (see Air pollution and greenhouse gas emissions) are:

**Litres Diesel Saved**=9357,647 Litres

**Price Diesel:** The average of diesel price in Romania is around **1€/liter**.

$$CashFlow = 9357.648 \frac{\text{€}}{\text{Year}} - 1619.76 \frac{\text{€}}{\text{year}} = 7737.88 \text{ €/year}$$

Therefore the Payback period will be:

$$Payback \text{ period} = \frac{80988,35 \text{ €}}{7737.88 \frac{\text{€}}{\text{Year}}} = 10.466 \text{ Years}$$

### NPV and IRR:

The equation for the **Net Present Value** is:

$$NPV = -I_o + \sum_{t=1}^n \frac{CashFlow}{(1+DiscountRate)^t} \quad (42)$$

Where:

**I<sub>o</sub>**: Is the initial investment

**N**: is the investment period

A **positive NPV** means that the inversion is profitable and should be accepted, because we will get a profit because the return rate is higher than the discount rate

A **NPV=0** means that it should be accepted with conditions, since it does not bring neither benefit nor loss.

A **negative NPV** should be rejected

As for Internal Return Rate (**IRR**):

It is the rate when NPV equals to zero.

$$NPV = -I_0 + \sum_{t=1}^n \frac{CashFlow}{(1+IRR)^t} = 0 \quad (43)$$

A **positive internal rate** means, that IRR is bigger than the discount rate, it would mean that the return rate from the inversion is greater than the discount rate considered, and you gain profit from the investment you have invested in. The project should be accepted.

An **equal IRR** would mean that you neither lose neither win money, the project should be accepted.

When the **IRR is smaller** than the Discount rate, it means, that the inversion is not profitable, should be discarded.

The NPV for the project is of **7088.42 €** and a IRR of **6%** which is higher than the considered Discount rate of **5%** (see Table 64)

	SAVINGS	COST	PROFITABILITY		
	FuelPriceSaved (€/year)	O&M (€/year)	Cash-Flow	Cumulative Cash-Flow	NPV (€)
0			- 88.988,35 €		
1	9357,648	1619,76	7.737,89 €	7.737,89 €	-77.732,32 €
2	9357,648	1619,76	7.737,89 €	15.475,78 €	-71.048,04 €
3	9357,648	1619,76	7.737,89 €	23.213,66 €	-64.682,06 €
4	9357,648	1619,76	7.737,89 €	30.951,55 €	-58.619,22 €
5	9357,648	1619,76	7.737,89 €	38.689,44 €	-52.845,09 €
6	9357,648	1619,76	7.737,89 €	46.427,33 €	-47.345,92 €
7	9357,648	1619,76	7.737,89 €	54.165,22 €	-42.108,61 €

8	9357,648	1619,76	7.737,89 €	61.903,10 €	-37.120,70 €
9	9357,648	1619,76	7.737,89 €	69.640,99 €	-32.370,31 €
10	9357,648	1619,76	7.737,89 €	77.378,88 €	-27.846,12 €
11	9357,648	1619,76	7.737,89 €	85.116,77 €	-23.537,38 €
12	9357,648	1619,76	7.737,89 €	92.854,66 €	-19.433,81 €
13	9357,648	1619,76	7.737,89 €	100.592,54 €	-15.525,65 €
14	9357,648	1619,76	7.737,89 €	108.330,43 €	-11.803,60 €
15	9357,648	1619,76	7.737,89 €	116.068,32 €	-8.258,78 €
16	9357,648	1619,76	7.737,89 €	123.806,21 €	-4.882,76 €
17	9357,648	1619,76	7.737,89 €	131.544,10 €	-1.667,51 €
18	9357,648	1619,76	7.737,89 €	139.281,98 €	1.394,63 €
19	9357,648	1619,76	7.737,89 €	147.019,87 €	4.310,96 €
20	9357,648	1619,76	7.737,89 €	154.757,76 €	7.088,42 €
				154.757,76 €	7.088,42 €
<b>Discount Rate:</b>		0,05	<b>IRR:</b>		6%

**Table 64: NPV and IRR of the system.**



**Compilation of case studies of applying renewable energies to local  
development transnationally implemented**



Co-funded by the  
Erasmus+ Programme  
of the European Union





# Project plans





**Compilation of case studies of applying renewable energies to local development transnationally implemented**



Co-funded by the  
Erasmus+ Programme  
of the European Union



## 9. Project Plans



**Figure 40: Distribution plan**

On Figure 40 is showed an aerial view of the farm, and the suggested installation location for the system:

In red the location of the solar panels.

In orange the location of the wind turbine.

In green the location of the different elements (charge regulators, inverters) and the battery system.

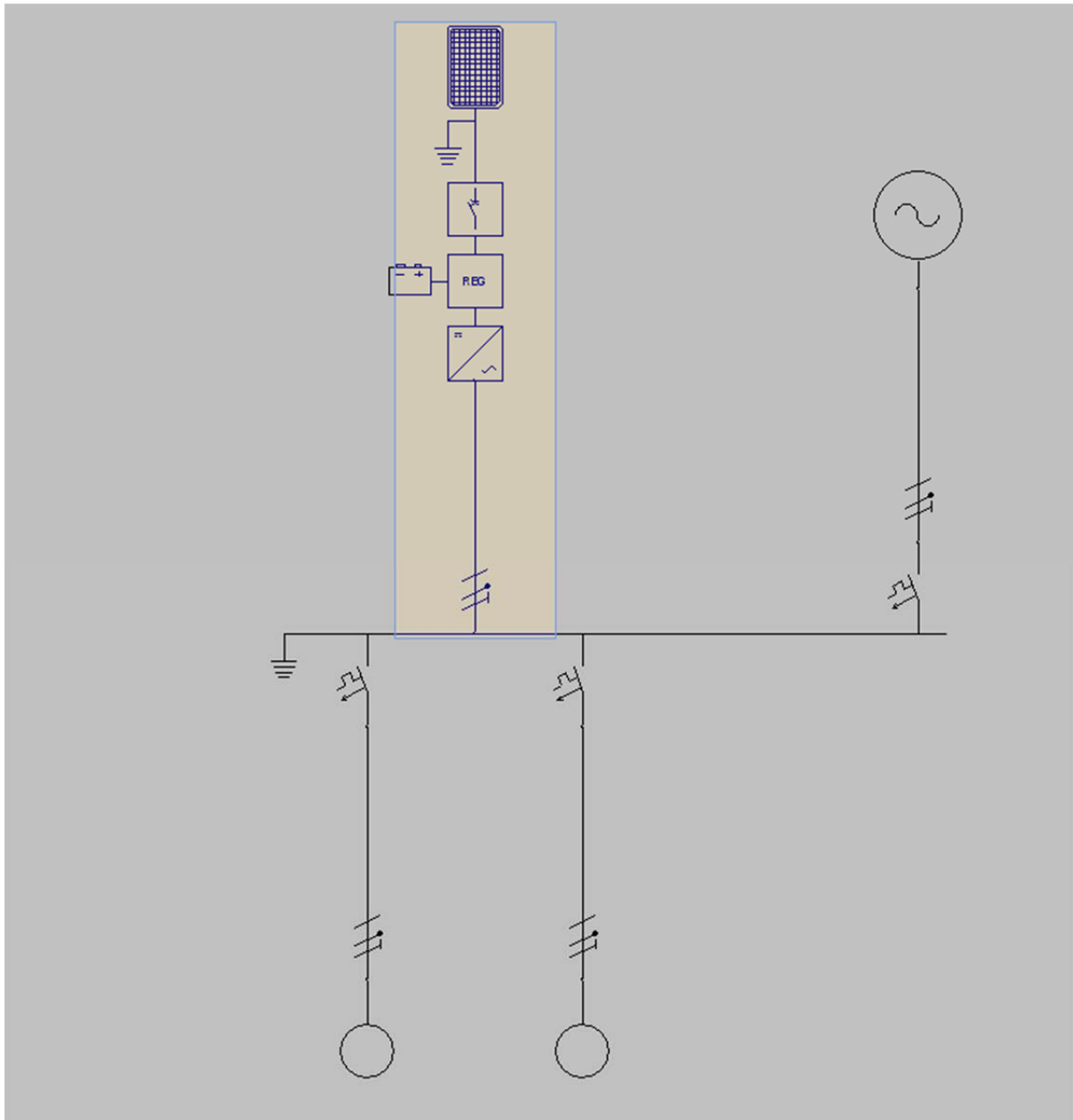

Figure 41: Electric scheme of the installation including generator.





**Compilation of case studies of applying renewable energies to local  
development transnationally implemented**



Co-funded by the  
Erasmus+ Programme  
of the European Union





REPORT OF THE CASE STUDY ON RENEWABLE ENERGIES TO LOCAL  
DEVELOPMENT TRANSNATIONALLY IMPLEMENTED

# Study concerning optimization of photovoltaic lighting system in Margineni village

Dora Okos

Eszterházy Károly University

[okosdora7@gmail.com](mailto:okosdora7@gmail.com)

Case study tutor: Puiu Gabriel

Renewable energies tutor: Jose Segarra Murria

Rural development tutor: Vicent Querol

English tutor: Csaba Szűcs

Professional supervisor: Valerica Rusu

General Electric

Bacau, April 2017



**Compilation of case studies of applying renewable energies to local development transnationally implemented**



Co-funded by the  
Erasmus+ Programme  
of the European Union

## Contents of the project

### 1. Introduction of the project

- 1.0.1. Data about the village
- 1.0.2. Data about the street
- 1.0.3. Photovoltaic lighting system
- 1.0.4. The importance of the control system
- 1.0.5. Current photovoltaic lighting system in Margineni
  - 1.0.5.1. Teceo 1 type
  - 1.0.5.2. Technical datas
- 1.1. State-of-art in the problem domain
- 1.2. Design alternatives to be considered
  - 1.2.1. Potential products that are able to work in control system
  - 1.2.2. Types of control systems
- 1.3. Descriptions of the final solutions
  - 1.3.1. LED Lamp
  - 1.3.2. Solar panel
  - 1.3.3. Photovoltaic charge regulator
  - 1.3.4. Battery
  - 1.3.5. Remote control
  - 1.3.6. Pole, battery box
  - 1.3.7. All components in summary
- 1.4. Impact of the project for the rural development
  - 1.4.1. Environmental impact
  - 1.4.2. Social and rural impact
- 1.5. Conclusions
- 1.6. References

### 2. Calculations and design

- 2.1. Photovoltaic system sizing

### 3. Budget and economic analysis of the project

- 3.1. Budget of the installation

### 4. Project plans

- 4.1. Location plan of the installation
- 4.2. Distribution plan





- 4.3. Electric scheme of the installation plan
- 4.4. Structure plans of the elements/illuminated area



# Memory of the project



**Compilation of case studies of applying renewable energies to local development transnationally implemented**



Co-funded by the  
Erasmus+ Programme  
of the European Union

## 1. Introduction

This case study presents of a photovoltaic lighting system installation that could supply power to public lighting, and a new development which presents the design of a photovoltaic system with a centrally managed system on a street where currently there is not any lighting system in operation in Margineni village.

### 1.0.1. Data about the village:

- Margineni is a commune in Bacau County, Romania.
- The commune's members are: Margineni, Barati, Trebes, Padureni, Poiana, Blidaru, Budului Valley, Podis and Serpeni.
- Coordinate: 46°35'19''N 26°48'23''E
- Population: about 9400
- Specific Climate
  - Average temperature: 9,2°C
  - Warmest month, July average temperature: 21,2 °C
  - Coldest month, January average temperature: 4,1 °C
  - Thermal amplitude annual: 25,2 °C
  - Average value of precipitation: 542mm/year
  - Prevailing winds: North and Northwest
  - The average value of speed wind: 2.1 m/s
  - The annual average of sunshine: 2000 hours



Figure 1: Margineni

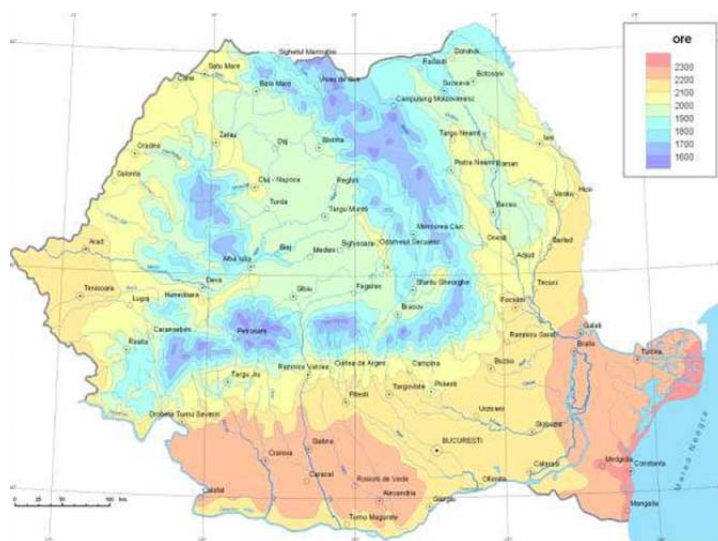

Figure 2: Hours of sunshine in Romanina

### 1.0.2. Data about the street:

The street where I have designed the photovoltaic lighting system in this case study is an access street to the workstation (pumping and chlorination) of the Regional Water Company in Margineni village.

Width: 4m

Length: 150 m



Figure 3: Map view from the street in Margineni

#### Regional Water Company (CRAB S.A.):

The company manages the drinking water supply, domestic sewage as well as the industrial run off from Bacau County according to the regulations of the water supply and sewerage.

In 2011 the S.C. Regional Water Company Bacau obtained certification of the integrated system of quality, environmental management and health and safety at work in compliance with the requirements of international standards.

This company is very important for Bacau County, therefore it is also important that transport is safe and controlled between the workstations. Currently it is necessary to install a lighting system to this street.

In order for the design to be successful, we need to know everything about the public lighting system in the village, and to analyze the possibilities to choose the best solution.

### 1.0.3. Photovoltaic lighting system

The solar panels / or photovoltaic cells – directly convert the radiation energy of the Sun into electricity. The construction elements compose of photoelectric solar cell semiconductor material, which generates an electrical signal when exposed to light radiation. The principle of operation is as follows:

When photons of light from the semiconductor crystal surface after absorption with the crystal excite valence electrons, the electrons are in a higher energy level (conduction band), the free charge carriers are formed. The charge is carried to an external load passing creating a closed circuit and thus electricity is generated. The solar panels directly provide electrical power, which is converted by means of inverter power voltage.

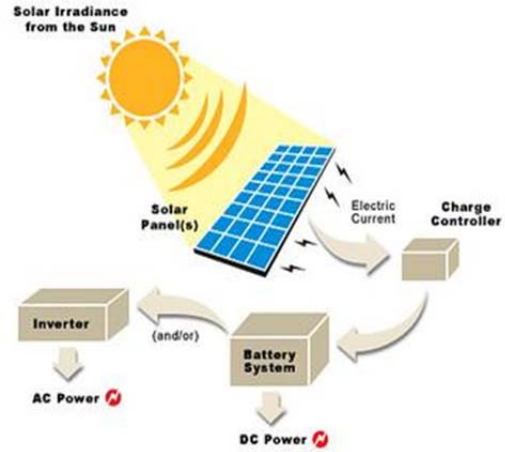

Figure 4: Operating principle of a PV system

Nowadays photovoltaic lighting systems are very popular because, owing to its use of solar energy, we can produce light, thereby solving the issue of street lighting. The most modern technology available is the LED (Light Emitting Diode) street lighting installation. The reason for the popularity is the energy saving. Compared to conventional street lighting, the photovoltaic system can save up to 50 or 80% energy.

The core of LED as the light source is that light is not created by means of a filament or gas discharge as in traditional incandescent lamps or compact fluorescent tubes, but through integrated semiconductors (diodes).

LED in the public lighting:

- More than 50 000 hours of life
- A small amount of waste
- There is no flicker of light close to natural light effect
- Low energy consumption (50-80% reduction) and high brightness
- Low power dissipation, low heat generation
- Power without delay, immediately lighting.



Figure 5: LED lamp

### 1.0.4. The importance of the control system

LEDs are energy efficient by design. Simply using LED lamps or fixtures can help a facility to meet updated system and energy codes while reducing electrical consumption and cost. For the same reason it is possible to control any light source – to maximize energy savings, extend system life, enhance flexibility, increase productivity, and provide a safe and comfortable environment for the inhabitants.

A wide range of controls are available – from a single switch or dimmer to a centralized lighting control system – to provide maximum flexibility, as well as measurement and reporting tools to help effectively analyze the energy savings being achieved with the lighting and control installation. Easy-to-install wireless controls facilitate simple retrofit, reducing installation and programming costs and improving the return on investment (ROI).

Regardless of the control system to be chosen, it is critical to work with a manufacturer who can guarantee compatibility and performance, eliminating many of the common concerns and issues that are seen with LED installations.

#### Maximizing savings, life, and performance

Dimming LEDs, similar to the process with fluorescent sources, save energy at a roughly 1:1 ratio. This means that if you dim LEDs down to 50% of their light output, you save nearly 50% of the associated energy. While it is true that LEDs are already very efficient compared to almost any other light sources, you save even more energy by dimming them.

Dimming LEDs also makes run cooler, extending the life of the electronic components in the driver, as well as the phosphor in the LEDs. This will potentially double or triple the useful life of the LED lamp or module. Research is ongoing to better quantify the relationship of dimming LEDs and lifetime extension.

LED lighting provides linear energy savings relative to dimming levels.

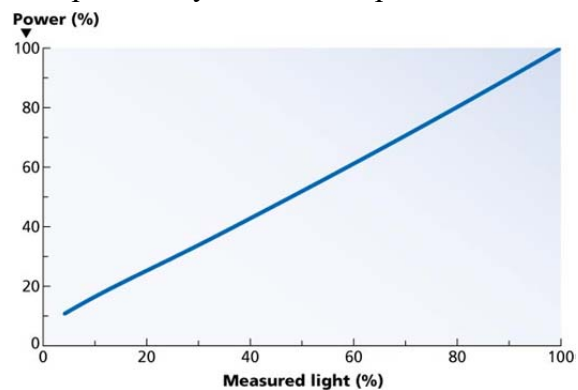

Diagram1: Linear straight between power and lighting

New constructions enable the use of either LED lamps or LED fixtures and offer a wide variety of control options. Retrofit applications are often limited to LED lamps, and the control options will be limited as well. Defining the application will determine how to think about the other factors in a LED-based lighting and control system.

The basis of these lamps have integral drivers that determine whether they are dimmable, and if so, the dimming performance. LED fixtures can vary from cove lights to downlights and usually have an external driver. Some fixture manufacturers offer different driver options (fig. 6) on the same fixture to support different control technologies or applications (such as dimmable vs. non-dimmable). It may even be able to specify an optimal drive from another manufacturer that includes the desired feature set.

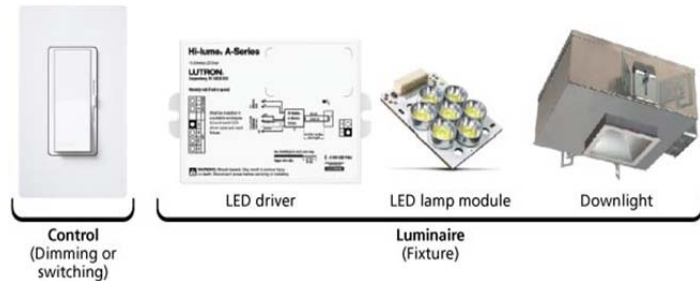

Figure 6: Fixture and control system

In the case of luminaires, a driver that meets the project requirements has to be chosen.

It is necessary to check with the driver or fixture manufacturer to be confident that the right product is chosen - drivers are available that can dim LEDs from 100% to 1% light, offering smooth and continuous dimming for both constant-current and constant-voltage sources. The long-life benefits of LEDs will be reduced if the driver is not designed for an equally long life.

#### Control type to LED product operation

There are many types of controls and control systems from high voltage (traditional phase control or reverse phase control) to low voltage (0-10V, DMX, DALI) and even some new entries with embedded wireless connectivity in the lamp/fixture.

While there have been a variety of control technologies available for years, the proliferation of LED lighting has caused many applications to move away from the typical control choices used for standard incandescent loads. Additionally, the inherent controllability of LEDs makes it likely that more applications will incorporate controls. Therefore, training on available control technologies, such as 0-10V, forward or reverse phase, EcoSystem, or others, it will be necessary to ensure the proper pairing of the controls with fixtures that support that technology.

High peak current in LED lamps that occurs on each half-cycle of the AC line voltage can also damage dimmers.

A holistic approach to LED control can help meet and exceed customer expectations. Technologies are improving, control options are expanding, literature and general knowledge is increasing, and LEDs can now be effectively used in virtually any type of commercial application. By choosing the right manufacturer and considering key issues, it will be easier than ever to provide customers with a LED lighting and control system that meets energy-saving, performance, and aesthetic expectations.



### 1.0.5. Current photovoltaic lighting system in Margineni:

- Total amount: €3.5 million
- The system's installation date: October, 2015.
- The length of the public lighting network in Margineni commune: 70.12 km and 1606 pillars.
- Each lighting pole is a standalone system.
- The investment is not made throughout the village as there are some streets where traditional street lighting is currently operating, or where public lighting is non-existent.

In the commune of Margineni two classes of lighting can be identified in harmony with the two categories of the lighting of road traffic, which is as follows:

ME3a type: with important traffic

- train length: 15,25 km
- 510 systems
- width of the roadway: 7m
- alternating poles bilateral arrangement
- min. distance between 2 poles on the same side: 60m
- where alternating bilateral → unilateral → arrangement is not allowed min. distance between 2 successive poles: 30m
- max. mounting height body lighting: 8m above the roadway
- max. length of the mounting bracket to the body luminaire shall not exceed 2m
- maintenance factor: 0,85 (cleaning, lighting twice a year)

ME5 type: with little traffic

- trail length : 54,85 km
- 196 system
- width of the roadway: 7m
- alternating poles unilateral arrangement
- min. distance between 2 poles: 50m
- max. height mounting body lighting: 8m above the roadway
- max. length of the mounting bracket to the body luminaire shall not exceed 2m
- maintenance factor: 0,85 (cleaning, lighting twice a year)

The main characteristics of body lighting IP66 ME3a, and ME5 type are: (IP66 is a notation, which means: fully protected against dust and powerful water jets and against immersion in water)

	<b>ME3a</b>	<b>ME5</b>
<b>Type</b>	TECEO 1	
<b>Casing</b>	aluminium	aluminium
<b>Lens</b>	heat treated glass, flat or curved	heat treated glass, flat or curved
<b>Degree of protection</b>	IP66 minimum	IP66 minimum
<b>Protection from impact</b>	minimal IK08	minimal IK08
<b>Minimum net flow of lighting</b>	6400lm	4300lm
<b>Driver power supply</b>	12-14V	12-14V
<b>Color temperature of light</b>	3000-4500 K	3000-4500 K
<b>Maximum total consumption</b>	80 W	60 W
<b>Minimum duration</b>	50000 h	50000 h
<b>Possibility of assembling</b>	vertically and horizontally	vertically and horizontally
<b>Vertical adjustment</b>	0°-15°	0°-15°
<b>Operating temperature</b>	-30°C - +35°C	-30°C - +35°C
<b>Maximum weight</b>	12 kg	12 kg
<b>Producer</b>	Energobit Schreder Lighting	

Table 1: Main characteristics of the two different road categories

### 1.0.5.1. Teceo 1 type

#### Maximum energy savings

A minimal total cost of ownership was the driving force behind the development of the Teceo range. It is equipped with LEDs and various dimming and remote management options for a dramatic reduction in energy consumption. It offers a very competitive alternative to luminaires equipped with traditional light sources such as high-pressure sodium lamps.



Figure 7: Teceo1 lamp

#### Lensoflex®<sub>2</sub>

Teceo luminaires are equipped with second generation LensoFlex®<sub>2</sub> photometric engines that have been specifically developed for lighting spaces where the wellbeing and safety of people using the environment is essential.

This system is based upon the additional principle of photometric distribution. Each LED is associated with a specific lens that generates the complete photometric distribution of the luminaire. It is the number of LEDs in combination with the driving current that determine the intensity level of the light distribution.



Figure 8: Teceo1 lamp

#### Performance and flexibility

The Teceo luminaires are equipped with photometric engines composed of modular quantities of LEDs so that they can offer a wide range of lumen packages. They can also be equipped with a variety of drivers and dimming options.

The Teceo luminaires can be adjusted on-site for optimal photometric performance. This flexibility ensures that the light distributions are specifically adapted to the real needs of the area to be lit.



Figure 9: Teceo1 lamp

#### Smart lighting

The Teceo luminaires can integrate the Owlet range of control solutions to operate either in stand-alone mode, in an autonomous network or in an interoperable network.

Dimming scenarios and light-on-demand features equipped with sensors can adapt the lighting to the real needs of the place and the time to ensure safety and well-being in the most sustainable way.



Figure 10: Teceo1 lamp

### Futureproof

Using state-of-the-art technology, Teceo luminaires have been designed to fulfil the FutureProof concept. The photometric engine is IP 66 sealed to protect the LEDs and lenses from coming into contact with the outside environment and so maintain photometric performance over time.

The optical unit can be easily removed, allowing real on-site replacement at the end of its service life in order to take advantage of future technological developments.

This easy and rapid procedure reduces maintenance costs and contributes to reducing the total cost of ownership.

### At the forefront of sustainability

The Teceo 1 luminaire can take advantage of its very low power consumption to be supplied with solar energy to offer an even more sustainable lighting solution. The Teceo 1 solar version – equipped with a driver specifically designed for this application – provides high efficacy which enables the panel size and battery capacity to be reduced, thus minimising the total cost of ownership.

The Teceo 1 solar version is the perfect tool to answer energy efficiency concerns and to offer a performing LED lighting solution for off-grid applications. The Teceo solar version range is suitable for both 12V and 24V batteries. It can provide a LED lumen package from 2,200 up to 9,000lm to meet the lighting needs of numerous applications such as car parks, bike paths, secondary roads, residential streets.

### Teceo 1

LENSOFLEX® <sub>2</sub>							Lifetime
Number of LEDs	Neutral white (4000K)	16 LEDs	24 LEDs	36 LEDs	40 LEDs	48 LEDs	100.000 h
Current: 350mA	Nominal flux (lm)*	2400	3600	4800	6000	7200	90%
	Power consumption (W)	18	27	36	44	53	
	Solar version - 12V	✓	✓	✓	✓	✓	
	Solar version - 24V	✓	✓	✓	✓	✓	
Current: 500mA	Nominal flux (lm)*	3100	4700	6300	7900	9500	
	Power consumption (W)	26	38	51	63	75	
	Solar version - 12V	✓	✓	✓	-	-	
	Solar version - 24V	✓	✓	✓	✓	✓	
Current: 700mA	Nominal flux (lm)*	4000	6100	8100	10200	12200	80%
	Power consumption (W)	36	55	71	90	107	
	Solar version - 12V	✓	-	✓	-	-	
	Solar version - 24V	✓	-	✓	-	-	

Table 2: Data of Teceo1 type

### 1.0.5.2. Technical data

Components:

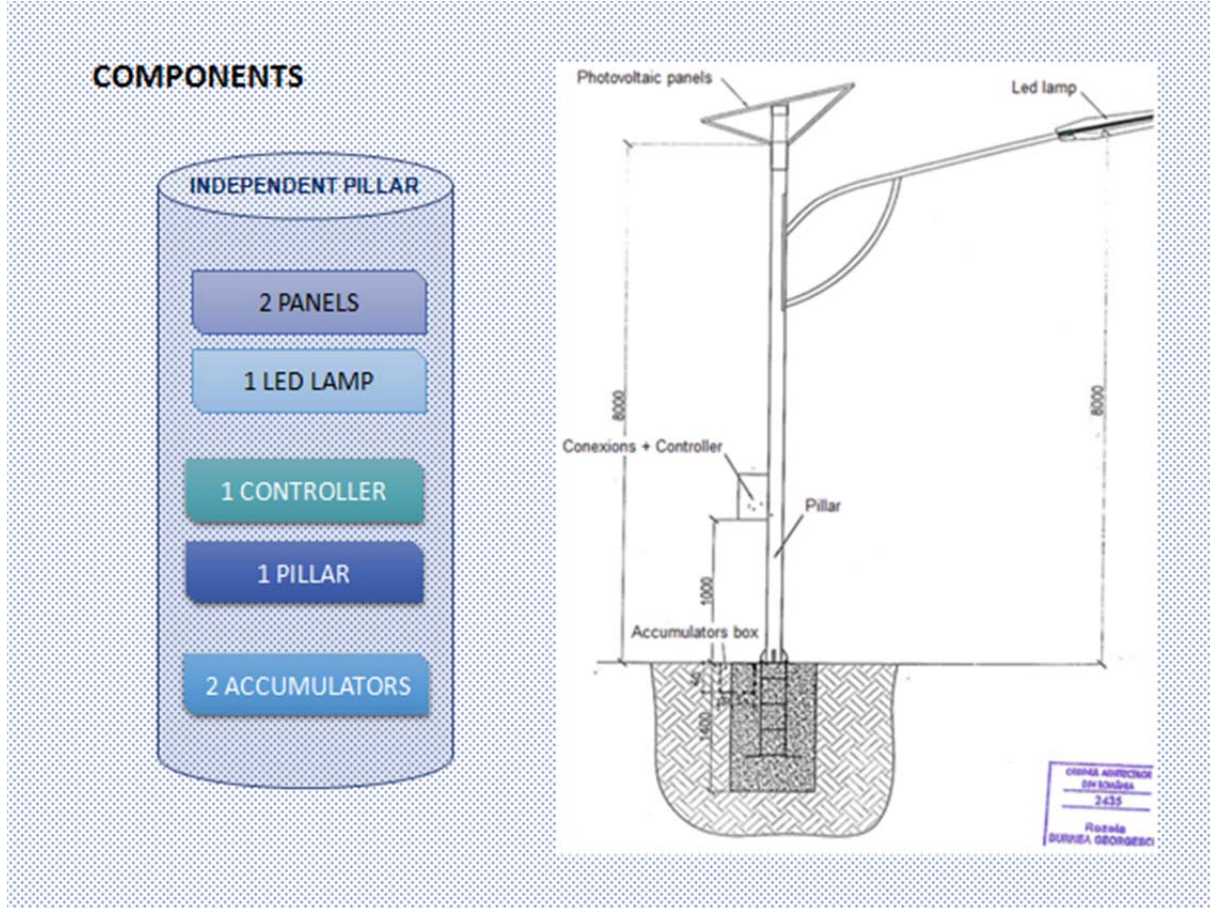

Figure 11: Components of the photovoltaic system

#### Photovoltaic module in normal operating conditions:

- Max power: 172W
- Max Voltage: 26,7V
- Max current: 6,7to
- Short-circuit current: 6,95
- Number of cells/module: 60pieces
- Cell type: polycrystalin
- Cell size: 156\*156mm
- length\*width\*height: 1700\*50\*1000 mm
- The bypass diodes include connections
- The maximum supported load: 5400 N/m<sup>2</sup>

### Controller:

- Operating Voltage: 12V
- Input voltage: 47 V
- Voltage output: max. 34 V
- Max. output current: 20A
- Operating temperature: -25°C – +55°C
- System monitoring and control of electrical parameters
- Voltage and current adjustment
- Automatic load reconnection
- Short-circuit protection

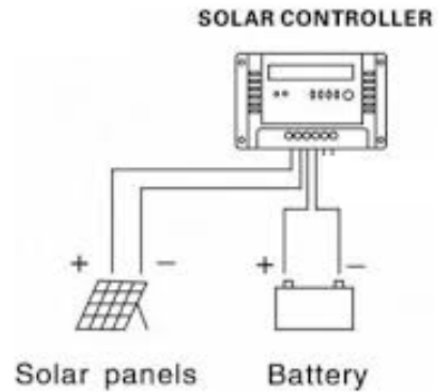

Figure 12: Controller

### Battery

- No maintenance
- Technology: deep cycle
- Electrolyte: acid sulfate
- Normal voltage: 12V
- Normal capacity: 100Ah
- Operating temperature: -20°C – +40°C
- Weight: 30 kg
- Size: 350\*200\*250 mm
- Explosiom safety valve



Figure 13: Battery

### Pillar

- Material: steel OL37
- Mounting: base plate clamped with anchors on insulated concrete foundation
- Anticorrosive painting or galvanizing
- Height: max 8,0 m
- Wind resistance: 150km/h
- Accessory:
  - Mounting box controller
  - Battery mounting box
  - Anchors embedded in the foundation

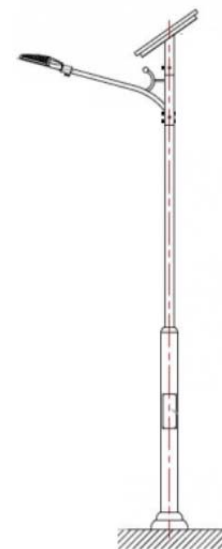

Figure 14: Pillar

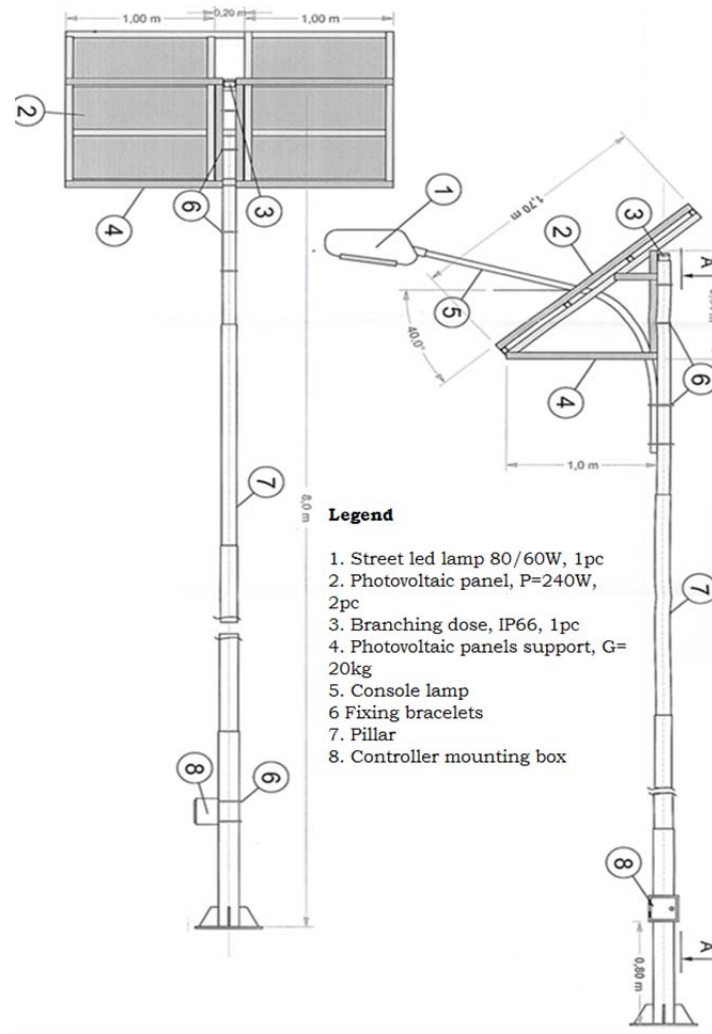

Figure 15: Structure

The main advantages and disadvantages of the photovoltaic lighting system are the following:

#### Advantages

- Low cost of ownership
- It does not emit pollutants during operation
- The Sun as an energy source is available everywhere
- Energy saving

#### Disadvantages:

- High production costs
- Long payback period
- Relatively low efficiency
- Pollutants that must be neutralized at the end of the life cycle

## 1.1. State-of-art in the problem domain

Reducing operating and energy consumption costs of public lighting is being promoted today. The operators, primarily municipalities, are considering a solution in this regard that the outdated lamps should be replaced with new, more energy-efficient light sources and luminaires. Unfortunately, this reconstruction program will usually provide technical solutions to investors in which energy efficiency is placed above all other technical aspects, and so lighting levels required by public lighting standards are often not met, the streets and squares are already under-lit.

In conformity with the 24 hour change of daylight, the highly changeable traffic, the variable meteorological conditions and some extreme situations on the roads, the intensity of street lighting should change in a dynamic manner. New technical devices and methods that are offered by technical progress will be necessary obviously for the realization of adaptive lighting.

A lighting control system as an intelligent network based lighting control solution that incorporates communication between various system inputs and outputs related to lighting control with the use of one or more central computing devices. Lighting control systems are widely used on both indoor and outdoor lighting of commercial, industrial, and residential spaces. Lighting control systems serve to provide the right amount of light where and when it is needed.

Further cost reduction potential of intelligent control system.

On the one hand, in Margineni village the replacement of the previous high-performance luminaires also resulted in cost savings thence the photovoltaic lighting system works well, and it saves significant energy and money for the village, but there are some streets where the lighting system is traditional, or there is no street lighting at all.

On the other hand, if we want to control lighting, it is necessary to know whether the fixtures from the current system are dimmable or not. The current system in Margineni works with Teceo1 type from Schreder manufacturer. This type of fixture is non-dimmable because each lighting pole is a standalone one, therefore it is necessary to choose a new type which can work in a controlled system.

The goals are to:

- increase energy savings,
- enhance energy efficiency,
- increase Energy Security,
- reduce energy import dependence,
- reduce environmental damage.



## 1.2 Design alternatives to be considered

There are a number of questions that inevitably occur:

- What happens when a new network or lamp is replaced? (If a lamp is replaced, what will be the technical condition of the network?)
- How much distance is needed for proper lighting? (40-50-60m, the distance from the road network is 4-7 m).
- Can the actual technology provide appropriate solutions for this specific situation?

During the design the following aspects should be taken into account:

- the column distances,
- points of light heights,
- road layout,
- road category.

In Margineni, there are two road categories:

- ME3a: important traffic
- ME5: little traffic

In the design it is necessary to determine the categories of road.

### 1.2.1. Potential products which are able to work in a controlled system:

Pegaso is produced by SPI Tecno. The Pegaso type has different versions of strength, from which the appropriate parameters must be selected, which are the following:

#### Lighting type of roads:

- Pegaso 24: for roads ME5 and ME6, speed 30km/h
- Pegaso 36: for roads ME4b, speed 50Km/h
- Pegaso 48: for roads ME3b, speed 90Km/h
- Pegasus 48+: for roads ME2b, speed 130km/h

#### Height of the posts:

- Pole height: 6 m Pegaso 24
- Pole height: 8 m Pegaso 36, Pegaso 48
- Pole height: 10 m Pegaso 48
- Pole height: 12 m Pegasus 48+

Cross reference:

- SAP70W lamp with replaceable Pegaso24 / 40W-48W
- SAP100W lamp with replaceable Pegaso24 / 55W - 65W
- SAP150W lamp with replaceable Pegaso36 / 80W - 100W
- SAP150W lamp with replaceable Pegaso48 / 80W - 100W
- SAP250W lamp with replaceable Pegaso48 / 110W-190W
- SAP400W lamp with replaceable Pegaso48 + / 125W-355W
- SAP400W lamp with replaceable Pegaso48 + / 150W-330W

Advantages of Pegaso:

- energy savings of up to 60%,
- Saving with remote control by up to 75%,
- low maintenance,
- easy accessibility to the led housing,
- perfect uniformity of light due to the asymmetric lenses,
- it does not contain hazardous substances.

### 1.2.2. Types of control systems

The dimming systems have two main groups: **analogue and digital**.

#### Analogue

Analogue dimming covers all dimming systems that do not transform the dimming signal into bits and controls the lighting in analogue manner.

#### Phase dimming

Phase dimming systems dim the lights by altering the supply voltage.

#### Leading & trailing edge dimming

Before LEDs, halogen lamps were dimmed with wall dimmers. These kinds of dimmers can still be used. But dimmers, drivers and LED-modules must be compatible with each other.

This type of controlling is accomplished without any need for an additional control wire. It involves connecting a dimmer in series between one of the mains wire and the equipment.

The dimmer cuts part of the mains voltage sinusoidal waveform to a greater or lesser extent in order to dim luminous flux even from 1% to 100% (this value depends on the dimmer and the driver).

Depending on how the driver makes the mains voltage cut, it is possible to distinguish between two types of dimming:

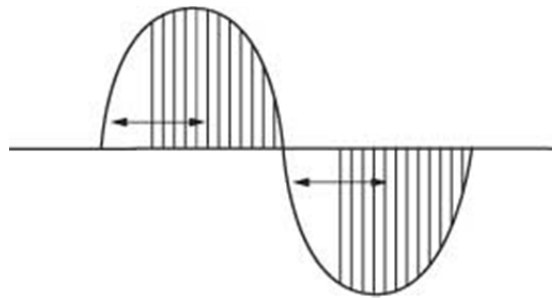

Figure 16: Leading-edge dimming

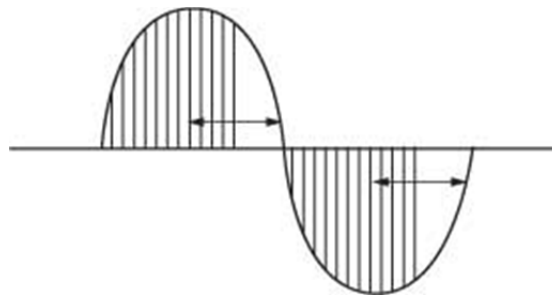

Figure 17: Trailing edge dimming

Dimming cut-off takes place in the wave on its ascending side, from the beginning (phase cut-off at ignition). This is traditionally used in halogen lamps supplied through electromagnetic transformers.

Dimming is achieved by cut-off in the wave on its descending side, from the end cutting backwards (phase cut-off at switch off). This way of dimming causes less interference than leading-edge dimming.

There are dimmers and equipment that support both types of dimming, and others that support only one type.

### 1-10V regulation

The 1-10V system enables dimming of the luminous flux from around 1...10% to 100%. This is done by sending an analogue signal to the equipment over an additional, two-wire control line. These control wires have positive and negative polarities respectively and that must be kept in mind when wiring up the system.

The analogue signal has a direct voltage value of between 1V and 10V. 1V – or short circuiting the fixture’s input control – gives the minimum light level, while 10V – or leaving the input control circuit open – gives out the maximum light level.

The International Standard IEC 60929 defines the regulation curve. The regulation curve represents the relationship between the control line voltage and the luminous flux. It reflects a practically linear relationship in the range of 3V to 10V.

To get a response adapted to that of the human eye it is possible to use logarithmically controlled potentiometers.

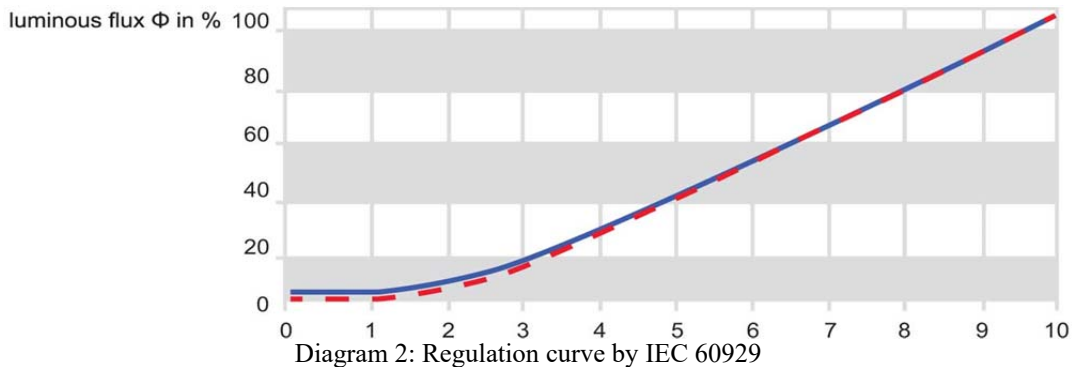

These luminaires result in power control of 1-10V brightness. The driver supplies a current to the controller through equipment control terminals. The controller current must be from 10µA to 2mA. The maximum control line current is obtained with a voltage of 1V and the minimum with a voltage of 10V.

Touch Control Push Button (analogue but can be connected to a digital systems)

Touch Control is a system that enables the simple and economic dimming of luminous flux. It uses the mains voltage as a control signal applying it with a standard push button on a control line without any need for specific controllers. The Touch Control system enables users to carry out the basic functions of a regulation system with a power-free pushbutton. Depending on how long the button is pressed, it is possible to switch the light on or off or dim it. Switching the light on or off is done by short, sharp pressing or “click”. If the button is pressed for a longer time, it is possible to dim the luminous flux between the maximum and minimum levels alternately.

**TOUCH**

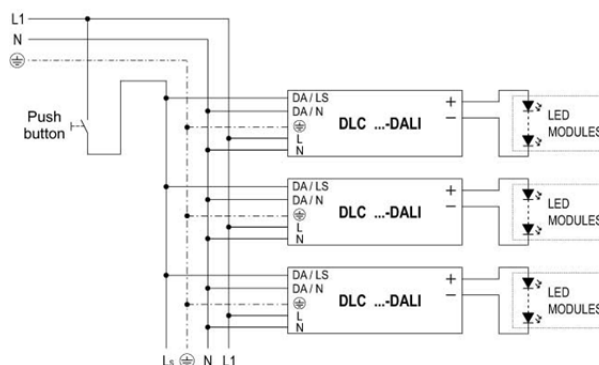

Figure 18: Touch dimming

## Digital

Digital dimming covers all dimming systems that transform the dimming signal into bits and controls the lighting in digital format.

### DALI Regulation (digital)

As revealed by the meaning of the acronym, **D**igital **A**ddressable **L**ighting **I**nterface, DALI is a digital and addressable communication interface for lighting systems.

This is an international standard system in accordance with IEC 62386, which ensures compatibility and interchangeability between different manufacturers' equipment.

It is a bi-directional dimming interface with a master-slave structure. The information flows from the controller, which operates as the master, to the control gears that only operate as slaves. The latter carries out the orders or responds to the information requests received.

Digital signals are transmitted over a bus or two-wire control wire. These control wires can be negatively and positively polarized, though the majority control gears are designed polarity free to make connection indifferent.

## DALI

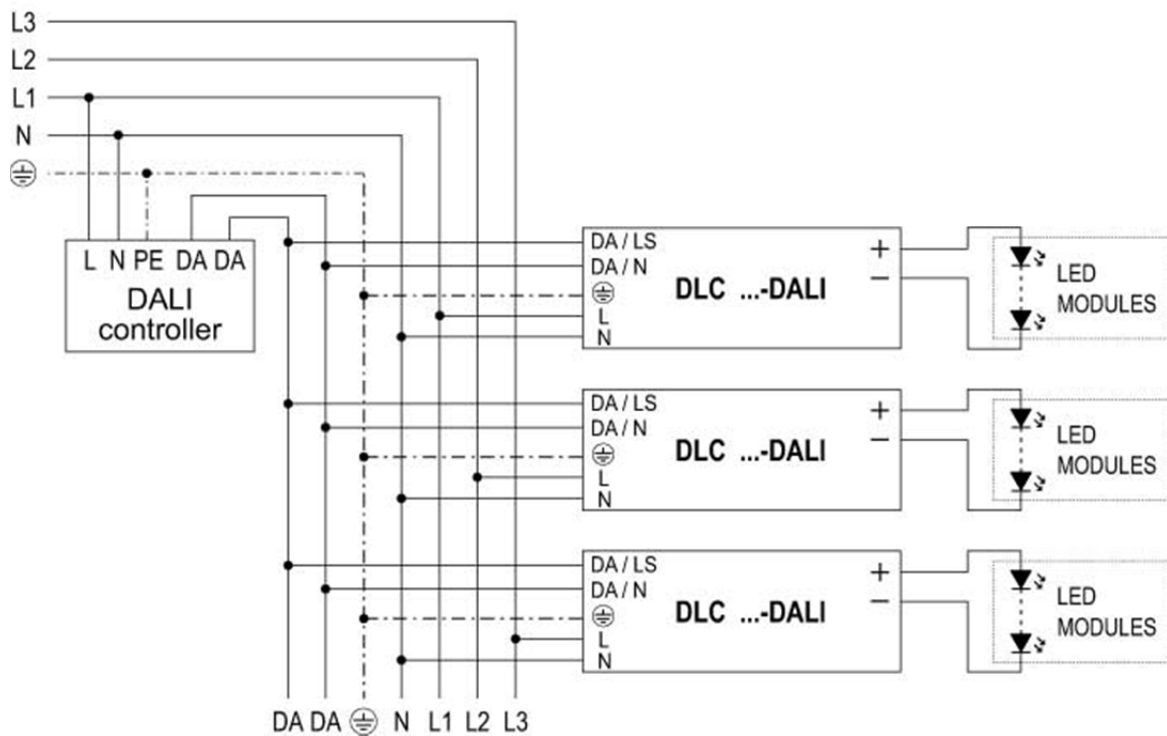

Figure 19: DALI dimming

Consequently, the DALI interfaces offer wiring simplicity in addition to great flexibility when it comes to designing the lighting installation.

The maximum voltage drop along the control line must not exceed 2V with the maximum bus current of 250mA. Therefore, the maximum wiring distance allowed depends on the cable cross section, but it must never exceed 300m in any case.

#### Wireless dimming options

The principle aim of lighting control is to reduce energy consumption and therefore the cost of annual energy budget is significantly reduced. Different mechanisms of control meet the desire of human and the operating conditions which are required. Utilizing photocell control enables automatic turning the street light fixtures on at sunset and off at sunrise. It is an efficient, simple, economic and common method of lighting control.

#### GSM wireless controller

Applying a GSM wireless controller in addition to photocell control will increase the capability of the system by monitoring the state of the light fixtures and controlling the switching. It allows to operate certain lamps and turn off others, or to dim the lights when the pedestrian and vehicular movement decreases. GSM is an open, digital cellular technology used for transmitting mobile voice and data services. It is a modern method in street lights controlling, especially because of its ability to cover long distances and increase the charging time for the batteries remotely for the Light Fixtures.

This approach can be used particularly by the municipalities and remote control centres often use GSM networks, and light fixtures will be controlled by computers. The determination of when light should be turned on or off will depend on the level of environmental light brightness such as the reduction of light intensity during low light brightness.

Applying this technology for public lighting, energy savings would be incredible, as well as resulting in far less light pollution. If the public lights were fitted with solar panels, making the system self-powering, the system would be more efficient. The utilization of light sensors provides a simple yet effective way for the automatic regulation of lighting power according to ambient light conditions thus enabling the system be turned on out of strict time schedules (e.g. during cloudy daytime).

The implementation of the proposed system could be further improved in the future by using modern simulation environment. The whole system is controlled by a PIC microcontroller.

The design has passed through several stages such as: selecting the practical components of the overall block diagram, purchasing these components, designing an external frame, mounting the photovoltaic solar panel, connecting it to the charge controller, interfacing GSM with PIC microcontroller and installing the LED lighting fixtures. Using LEDs lamps with GSM control system is a modern way in saving energy.

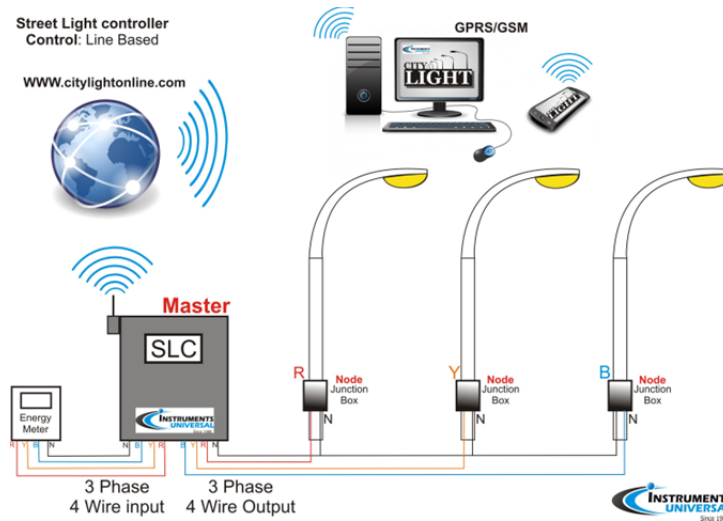

Figure 20: The structure of the GSM control system

Dimming interface	Advantages	Disadvantages
AC wiring (phase-cut)	No addition wiring required Can use existing phase-cut dimmers	Added circuitry in power supply Cannot dim smoothly to zero May exhibit flickering
Analog input (0-10V)	Can use existing 0-10V lighting controls Can dim smoothly down to zero Simple implementation in driver	Requires additional control wiring Requires controller
Logic control	Very simple form of dimming	Only suitable for two-level brightness
Digital input (DALI)	Standard for control of multiple luminaires Can include luminaire monitoring capability	Requires additional control wiring Requires controller
Digital input (DMX)	Standard is focused on theatre/stage lighting Can offer comprehensive control – pan, tilt, zoom, colour, image effects	Requires additional control wiring Requires controller Noise sensitive, no monitoring capability
Wireless	No additional wiring required Can offer comprehensive features	Driver and controller are more complex Wireless signals have limited range

Table 3: Advantages and disadvantages of different control systems

### 1.3 Description of the final solution

The street, which is the main factor in this case study, is an access street with low traffic.

The street in question has little traffic thus it belongs to the ME4b category.

Of the above described Pegaso products the registered and most appropriate type for the ME4b category is the Pegaso 36.

Therefore the most appropriate choice is the Pegaso 36 system by SPI Tecno producer.

#### 1.3.1. LED Lamp- Pegaso 36

Pegaso is an innovative product with performance modular and stand alone mode or controlled. The structure is a single cast aluminum incorporating the radiator 250W to dissipate the heat produced by the LEDs, a feature essential to ensure the product life of at least 103.000 hours of continuous operation. Much attention has been paid to the design of the electronic power supply and the LED drive design to ensure the product's lifespan. The asymmetrical lens can be detected in many types adapted to the geometry of the road, the height and spacing of the poles. 4000K versions are available on request for quantity. The IP66 - Insulation class I or II.

Technical data:

- Case: Die cast aluminium 250W painted with thermohardened polyester powders, offering high resistance to rust and external atmospheric agents. The opening of the lamp is facilitated by two latches and the cover is kept by a hinge at the tip.
- LED: high power used 2 or 3 W
- LED printed circuit board: Metalcore (Aluminium)
- Diffuser: Asymmetric lens
- Input voltage: 24Vdc
- Power Supply: 48V 130W (no electrolytic capacitors)
- Class: I or II.
- Installation: Pipe diameter: 60=68mm
- Operating temperature range: -25°C - +50°C
- Humidity range: 10% - 90%
- Weight: 8,2 kg
- Height: 8m
- Distance between two columns: 30m
- Net flow of lighting: 5580 lm
- Nominal consumption: 50W
- Color temperature of light: 3000 K
- Illumination angle: around 130°

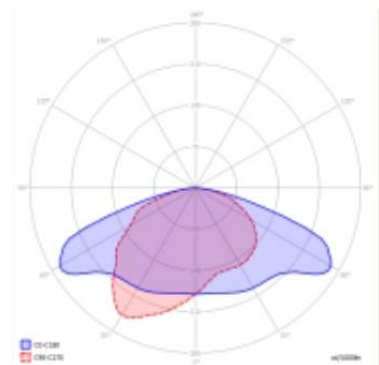

Figure 21: Illumination angle of Pegaso 36



### 1.3.2. Solar panel- Shinetime Solar XTP6-60-240

Electrical data:

- Peak Power Watts: 175 W
- Nominal Voltage: 27,7V
- Nominal Power Current : 6,32A
- Open Circuit Voltage: 34,1V
- Short Circuit Current: 6,75A
- Irradiance: 800W/m<sup>2</sup>

Operating Conditions:

- Maximum system voltage: 1000VDC
- Max series fuse rating: 15A
- Operating temperature range: -40°C - +85°C
- Max. static load front: 5400Pa
- Max static load back: 2400Pa
- Max hailstone impact: 40mm/4,5m/s

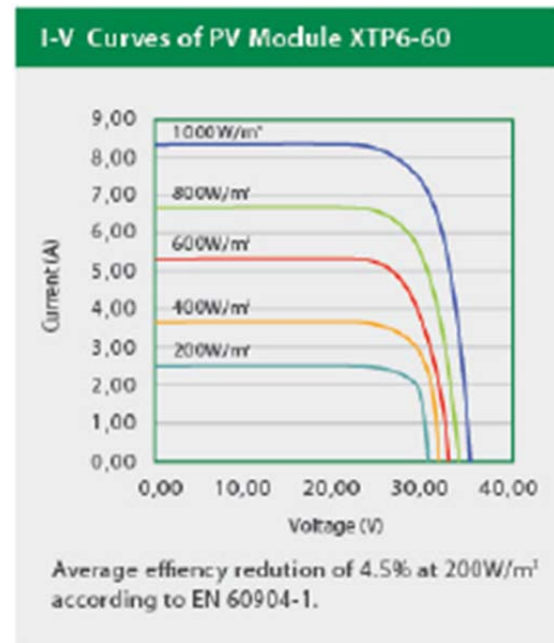

Figure 22: Curves of PV module

Mechanical data:

- Solar cells: Polycrystalline 156\*156mm (6 inches)
- Cells orientation: 60 cells (6\*10)
- Module dimension: 1640\*992\*40mm
- Weight: 19,5 kg
- Glass: High transparency low-iron tempered solar glass 3,2mm (0,13inches)
- Frame: Silver colour anodized aluminium alloy
- Junction Box: IP65 rated
- Cable: Photovoltaic technology cable: 4,0mm<sup>2</sup> (0,003 inches<sup>2</sup>), 900mm (35,4 inches)
- Connector: MC4 Compatible /IP65

### 1.3.3. Photovoltaic charge regulator: WRM-15

- MPPT recharge
- Wide voltage range on PV module input VPAN 0- 100V
- Maximum PV module power 250W for 12V battery and 500W for 24V battery
- Integrated blocking diode
- For sealed/GEL, flooded lead acid batteries and lithium-ion batteries (from Rev 1.9)
- Charge voltage compensated in temperature
- 12V / 24V battery voltage auto-detect
- 18 programs for load management
- 48 LCD symbols for user interface
- Low battery protection
- Over-temperature protection
- Protection for battery polarity inversion
- Overload protection on output
- IP20 metal box

WRM-15 is a complete solution for the realization of off-grid PV systems to power supply road signs systems, lighting systems, small low voltage systems and for the recharge of batteries inside caravans. This model of charge regulator has got a circuit of search of the maximum PV module's power (MPPT): regardless of battery voltage and its charge state, WRM-15 always makes the PV module work in its point of maximum power maximizing the energy extracted from the module and loaded into the battery. PWM charge regulators want PV modules with No. 36 cells for the recharge of 12V batteries and PV modules with No. 72 cells for the recharge of 24V batteries. This planning obligation is no more necessary with MPPT circuit where we can use the cheaper PV modules used in grid connected systems (with a number of cells different from 36 or 72) also in PV off-grid systems. You can also use amorphous PV modules that are normally not suitable to PWM charge regulators.

The several programs of load management, selectable by the user, make WRM-15 the complete solution in several applications; i.e. to power supply video cameras that have to work only during the day, or to power supply flashing systems / road signs that have to work only during night, or to power supply lighting systems that have to work only for a certain number of hours during the night. WRM-15 detects the day/night state according to the PV module's voltage; therefore it is not necessary to connect further sensors to the regulator. A wide display shows the working status of the regulator either through simple and intuitive icons either displaying the values of recharge current, battery voltage, energy produced.

#### General description

WRM-15 is a photovoltaic charge regulator for leaden electrochemical batteries either sealed (SEAL) or flooded lead acid (FLOOD). In fig. 1 there is a scheme of principle of WRM-15. A charging program for lithium-ion batteries with integrated Battery Management System (BMS) was introduced with firmware version 1.9. It is absolutely forbidden to connect

WRM15 lithium-ion battery without a BMS because it protects the battery from unsafe operating conditions that can lead the battery to explosion or to burn up.

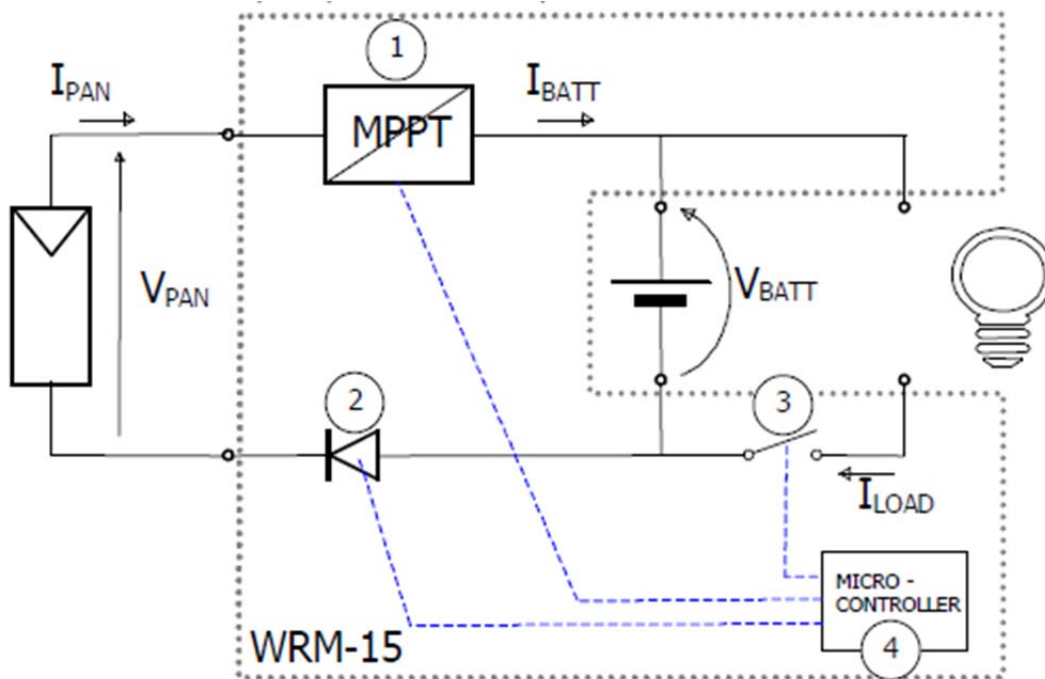

Figure 23: General structure of charge regulator

5- Recharge circuit: it adapts  $V_{PAN}$  and  $I_{PAN}$  (respectively voltage and current of the photovoltaic module) so to search the condition in which the power that is given by the PV module is maximum, thus realizing the MPPT (*Maximum Power Point Tracking*). In addition, it manages the battery recharge by reducing the current sent towards the battery when the voltage  $V_{BATT}$  exceeds its recharge voltage ( $V_{ch}$ ).

6- Series diode: it prevents the PV module from absorbing current from the battery during night when it is not lighted.

7- Circuit for the load control: it turns the load on/off according to the program that has been set from the user and it provides load detachment in case of low battery / overload / short-circuit on the load.

8- Microprocessor: it controls the whole circuit, it measures currents and voltages of PV module / battery / load and it shows them on the display.

WRM-15 charge regulator, thanks to the recharge circuit with MPPT, allows using a wide range of photovoltaic modules ensuring the optimum exploitation of the power. The PV module has to be chosen according to the nominal voltage of battery and respecting the constraints of the panel input of WRM-15: maximum voltage 100V and maximum panel power 250W with 12V battery and 500W with 24V battery.

### 1.3.4. Battery - FIAMM 12FGL27

Applications and advantages:

The batteries are designed for optimum performance and to protect against network disturbances. They are ideal for:

- Emergency lights
- Signage
- Security & Alarm Systems
- Industrial & Continuity Process
- UPS Applications
- Minor Traction
- Storage systems for renewable energy.

- VRLA AGM and gas recombination technology, with 99% of the internal gas recombined
- No maintenance; no topping up
- Not dangerous for transport by air / sea / rail / road
- 100% Recyclable

Data:

- Nominal voltage: 12V (2x)
- Weight: 9kg
- Dimension: 166\*175\*117\*125mm
- Grids: obtained by gravity casting alloy with calcium lead-highly pure tin
- Separators: completely absorbed electrolyte separators in glass fibre (AGM) high microporosity
- Terminal attack: fi threaded insert that guarantees high conductivity and allows easy installation
- Polar Sealing: high reliability, specially designed to prevent infiltration of acid in a wide temperature range
- Unidirectional safety valve: enables gas in excess to go out when overcharged
- Device antifi amma: prevents sparks or flames inside the battery
- Container and lid designed with thick walls in ABS for a high mechanical resistance
- Self-discharge: <2% per month



Figure 24: Battery

### 1.3.5. Remote control

The remote control is the ability to communicate with a SmartCity with some devices capable of creating large databases and counters and reduce light intensity with a variety of gas, electricity, water and street lights and various sensors. Its ease and versatility makes it particularly suitable for preparing a proprietary network that on the one hand is connected to the Internet and other peripherals through a transceiver radio frequency 868 MHz. The operator interface thanks to OrionView is able to communicate with all the devices on the network. The example below clarifies the case of public lighting.



Figure 25: Remote control

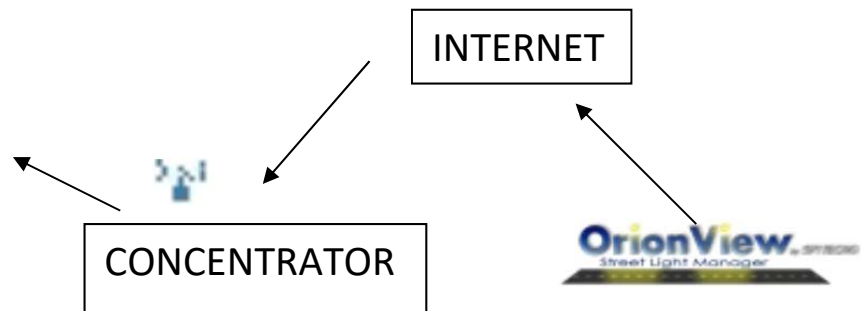
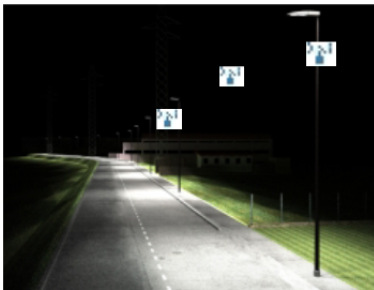

Figure 26: Network Connection

#### OrionView

The platform allows OrionView with a few clicks of the mouse and from any computer connected to the Internet to plan your electric bill while controlling the consumption of public lighting systems.

The system is a tool that installs OrionView and returns to the operators of public lighting system the ability to exercise the role of a real manager and could intervene in a completely automated manner. The system is able to send e-mails to pre-established lists of people of "Warnings" in the event of a fault; in this way it will reverse the current situation which is always the citizen that alarms the operator.

### 1.3.6. Pole - GLS Hline-T panel support and battery box

The technological development of the GLS HLINE street lamp is more widespread among the classical photovoltaic columns.

- High reliability and durability
  - Gel silicon battery technology with long service life
  - Up to 250 hrs of autonomy without Sun
  - Remote evolved features
  - Automatic dimming
  - Smart city functionalities
  - Full customizable design
- 
- Pole and panels support material: hot deep galvanized steel
  - Pole total Height: up to 12,5m
  - Height of light: up to 10m
  - Battery box placement: at the head
  - Maximum number of batteries: 2
  - Battery box material: steel galvanized thin steel
  - Type of anchor: foundation with bolts



Figure 27: Pillars

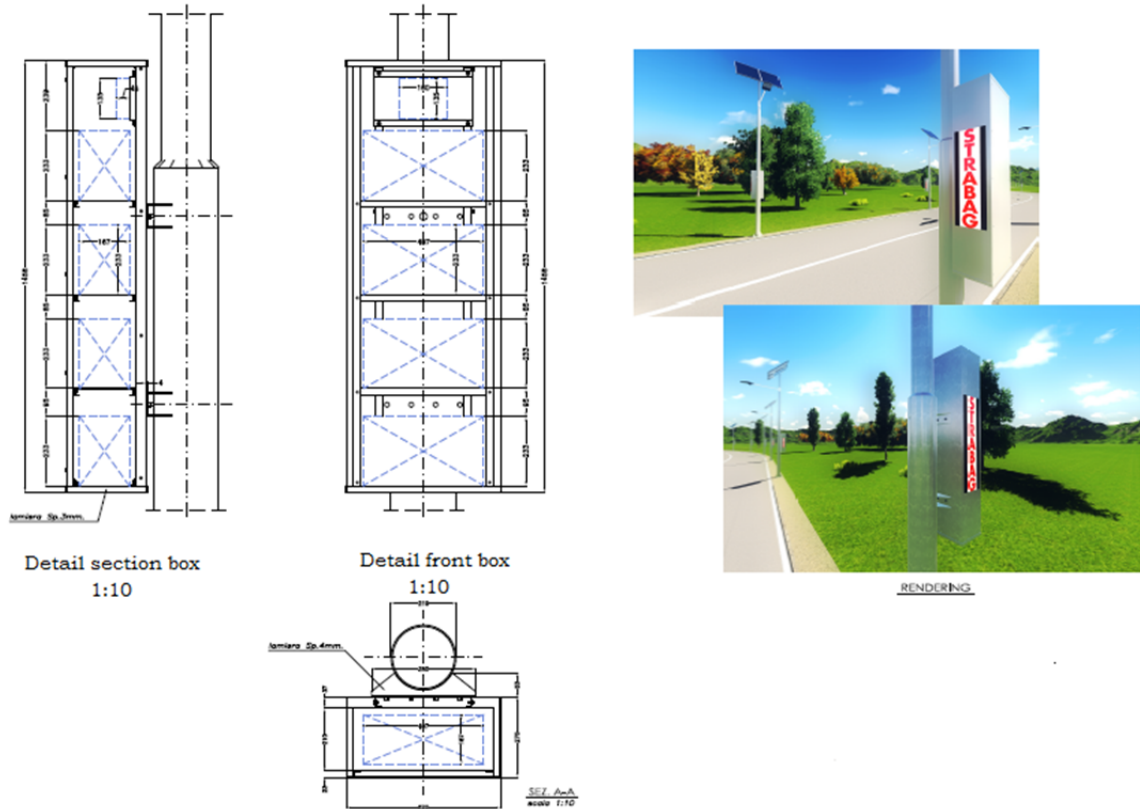

Figure 28: The structure of the battery box

### 1.3.7. All components and their numbers in summary

The street length is 150m, while the distance between 2 columns is 30m.  $150/30=5$ , therefore it is necessary to install 5 columns for adequate lighting.

Led lamp: 5 pieces

Solar panel: 5 pieces

PV charge regulator: 5 pieces

Battery: 10 pieces (5x2)

Remote control: 5 pieces

Pole and pole support: 5 pieces

Battery box: 5 pieces

## 1.4 Impact of the project for the rural development

### 1.4.0.1. Impacts of the photovoltaic lighting system for the rural development

The installation of such systems is widespread in urban areas, along the motorways, and in underdeveloped peripheral rural areas.

Although the commissioning of such systems in urban regions (and in developed rural regions or in areas having the potential to develop) can be justified, in certain aspects, innovative developments in economically backward rural areas have relatively higher marginal utility. In resource-deficient rural regions any (sustainable) development especially investment in innovative activities is highly beneficial, even if the direct job-creation ability is negligible.

The regional impacts of different photovoltaic systems, with special regard to investments of innovative nature, are of utmost significance. On the basis of urbanity and rurality, no difference can be revealed with regard to the currently available amounts of alternative energy including that of solar energy. Rural development must focus on the development of self-sufficiency in rural regions, an essential component of which is to accentuate the role of alternative energy production. There is a strong correlation between rural development and decentralized energy production. Decentralized energy production implies the use of local raw materials, local labour force and local investments and according to many, building a (green) country starts with villages.

In terms of energy utilization efficiency, the worst situation is to be found particularly in rural regions. It is an issue of great importance to supersede the approach to thinking solely in the context of large-scale supply systems. Instead, it is essential to create balance between small-scale power plants and large-scale supply systems. One aspect of the above balance is represented by the commissioning of PV systems, i.e. the emergence of local power stations in rural areas. Energy rationalization, while safeguarding environmental sustainability, also ensures sustainable economic development, therefore PV systems can certainly be regarded as developments congruent with community interests.

An outstandingly important aspect to be taken into account in relation with rural developments is to ensure that the deployment of PV systems do not result in land-use restrictions. In this context, a favourable situation is created by the fact that photovoltaic energy production can be combined with several other production methods (soil strength reinforcement, recultivation, pasturing, apiculture, vine-culture, horticulture, etc.). The demand for land brought into use by investments may as well reach high levels but owing to the aforementioned particularity, such high demand does not pose any barriers to investments and in view of the rapid pace of innovations, the future is likely to see a significant decrease in specific land-use demand.



These systems exert their effects typically through the diversification of the economic activity of a specific region while they can also enhance its prestige and offer further opportunities, such as:

- the emergence of renewable energy production locally, its development,
- partial or total replacement of local energy sources (energy consumption of business enterprises and residential energy consumption) with renewable energy,
- effective communication avenues to reach out to a given region's environmental consciousness and commitment to sustainability,
- involvement of local entrepreneurs in community developments based on local energy production,
- possibilities of setting up exhibition sites for events dedicated to renewable energy sources,
- modernization of energy utilization in a region, strengthening self-sufficiency,
- systems contribution to the demonstration of environmental education in a specific region and enhancing the efficiency of such education.

Local residents may need to consider providing support to solar energy utilization/production by offering special funds for this purpose. As a result, they could realize additional income (or more money is left in their pocket), which, in turn, will boost the region's internal demand. By the promotion of the local multiplication of the aforementioned case (equipped with a complex system of development tools), the revenue remaining with the region may increase. In this respect, small-scale, decentralized electricity production deserves special attention or, perhaps special assistance. Introduction to best-practices in solar PV parks may significantly enhance their spread and social acceptance and encourage both investors and governments providing space for installation to carry out partly similar developments. Unpredictable energy policy poses an increasingly serious obstacle to the expansion of photovoltaic parks in spite of all the positive examples of such developments throughout Europe.

In parallel with opportunities, there are a number of problems to work on. Economic sustainability of local governments seems to be unstable, while at the same time settlements pay particular attention to local economic development. Elements of sustainability do not carry equal weight in the task-orientation concepts of local governments. In the context of regional development, energy production-related projects may typically become successful if they are viewed as elements constituting a part of a well-designed complex system of development and if no short-term high returns are expected. In view of the technology - intensity of innovative industries, also solar PV systems require only a low level of labour force participation while at the same time both the local governments and the the spread of

renewable energy sources, including also the expansion of photovoltaic systems, depends predominantly on the changes in the pattern of fossil fuel energy markets, therefore, the success of a PV park and its impact on a region pose serious external risks in the short to medium-term.

The primarily indirect economic impacts of the projects could be significant. A well organised system of regional energy production is able to change consumption habits and trends and serve as a template for neighboring municipalities and areas.

Another issue of concern is that members of local communities do not seem to be ready for the adoption of alternative and innovative solutions, thus, it is not only the shaping of public perception of PV systems but also the development of assistance schemes may become necessary. After the use of energy generated by PV systems has become common among local governments, entrepreneurs and local residents, at the time of constructions, business undertakings engaged in the execution of the relevant work processes will see a temporary upswing. Another problem is that the aforementioned businesses are not necessarily (typically not) local undertakings either.

<p style="text-align: center;"><b>STRENGTHS</b></p> <ul style="list-style-type: none"> <li>• Massive development, the majority of potential participants are affected positively</li> <li>• Innovative economic presence in the region, potential spin-off.</li> <li>• The only future is local, regional, small-scale autonomous energy production and supply solutions, renewable energy sources and energy saving. It is based on lifestyle.</li> <li>• Long-term sustainable operation</li> <li>• Innovative solutions</li> <li>• Cheaper local energy</li> </ul>	<p style="text-align: center;"><b>OPPORTUNITIES</b></p> <ul style="list-style-type: none"> <li>• Local-level developments, innovations, incubation</li> <li>• Strengthening local capacity</li> <li>• Dynamically developing sector (very rapid innovation)</li> <li>• Installation of operating joint development of the region</li> <li>• The objectives of EU development policy</li> <li>• Special local segment of construction (Transient) Development</li> <li>• diversification of the structure</li> <li>• broader vision of the energy industry and the region foundation</li> <li>• The establishment of an alternative energy demonstration</li> </ul>
<p style="text-align: center;"><b>WEAKNESSES</b></p> <ul style="list-style-type: none"> <li>• Low not only international, but domestic visibility.</li> <li>• Poor cooperation and competition.</li> <li>• Landscape effect (negative).</li> <li>• Market coverage and operation in the region is up to suppliers (including component manufacturing).</li> <li>• Energy storage unresolved.</li> <li>• E-on network connection limitations.</li> </ul>	<p style="text-align: center;"><b>DANGERS</b></p> <ul style="list-style-type: none"> <li>• Energy Policy support is uncertain.</li> <li>• No substantive receptivity by the insufficient regional and income situation</li> <li>• Lack of information</li> <li>• The opportunity to gain competitive advantage is low</li> </ul>

Table 4: Analysis of the impacts of PV systems for rural development.

## 1.4.1 Environmental impacts

### Visual pollution

The design of a PV park requires special emphasis to be placed on specific factors, such as the selection of the appropriate land used for the construction, the assessment of environmental impacts, e.g., landscape effects, visibility in terms of the local landscape and natural heritage. Furthermore, it becomes necessary to ensure that the local community can formulate its views on the installation of the intended power plant. In case there are nature conservation areas in the neighbourhood, landscape effect and the impact of visual pollution become of paramount importance in the development of a PV park. A PV park located in the vicinity of landscape or natural heritage areas is likely to be detrimental to landscape enjoyment. The solar park must be prevented from becoming a feature overpowering the landscape.

### CO<sub>2</sub> emission

Atmospheric concentration of carbon dioxide is rapidly increasing with an annual growth rate amounting to 2 ppm (parts per million).

Energy consumption of a settlement and its CO<sub>2</sub> emission depend on several factors most important of which are the climate, the type of buildings, the used energy carriers, the structure of the economy, the size of the population, the modes of transport, and the leadership of business involved in photovoltaic system development and installation as well as the behaviour of citizens. We can influence the factors in a short time, however, most of them can only be influenced in a longer term.

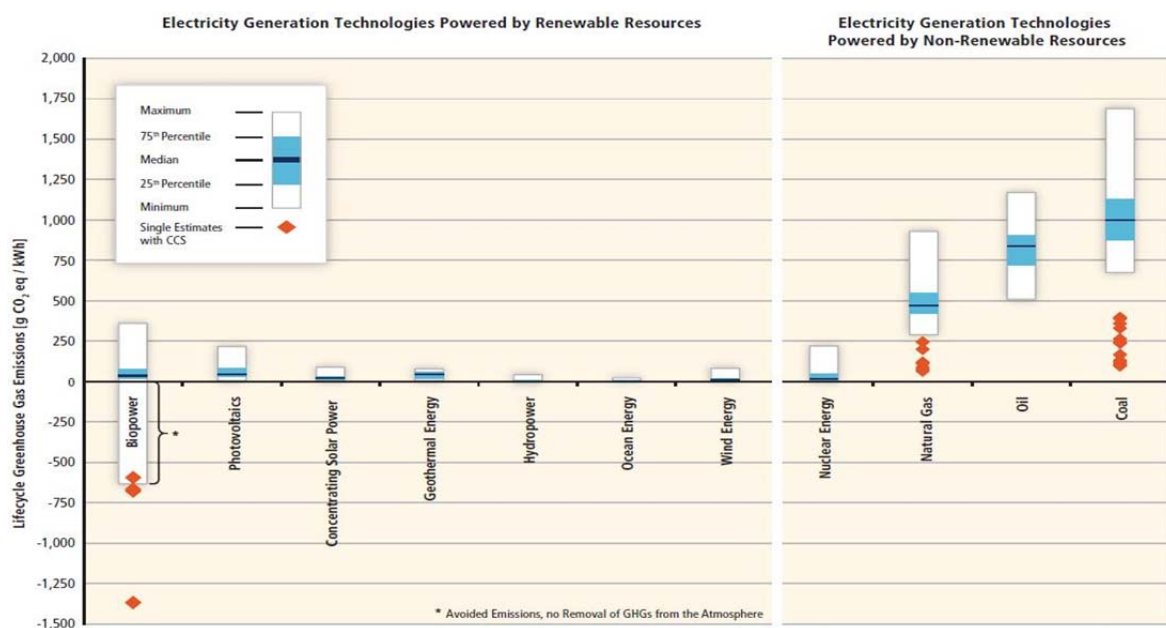

Diagram 3: CO<sub>2</sub> emissions

### Waste production and management

During their 20 to 30 year long lifetime photovoltaic panels do not produce either waste or pollution. Installed battery lifetime is around 15 years.

In that time any component or equipment replacement will be treated adequately by the approved recovery and recycling managers.

### Advantages

- No direct sunlight (Even overcast weather)
- Solar systems can easily place the existing roof structures
- Does not require soil and civil engineering work
- No interference with other existing infrastructure
- It does not require a building permit
- Silent operation
- Maintenance-free
- Cost-effective way of reducing CO<sub>2</sub> emissions
- The system is carried out by a single investment. From then on the system provides clean energy in a predictable manner for a minimum of 25 years. Since energy is produced by means of renewable energy the price depends on the investment.
- Maintenance is minimal, noiseless operation, since (unlike wind power plants) contains no moving parts.
- The world's economies are environmentally conscious and advanced (EU, USA, Japan) governing the transfer price of renewable energy brought explosive growth. The countries need to switch a higher proportion of the population to renewable energy sources.
- Investment promises high yields, but the risk is almost negligible.

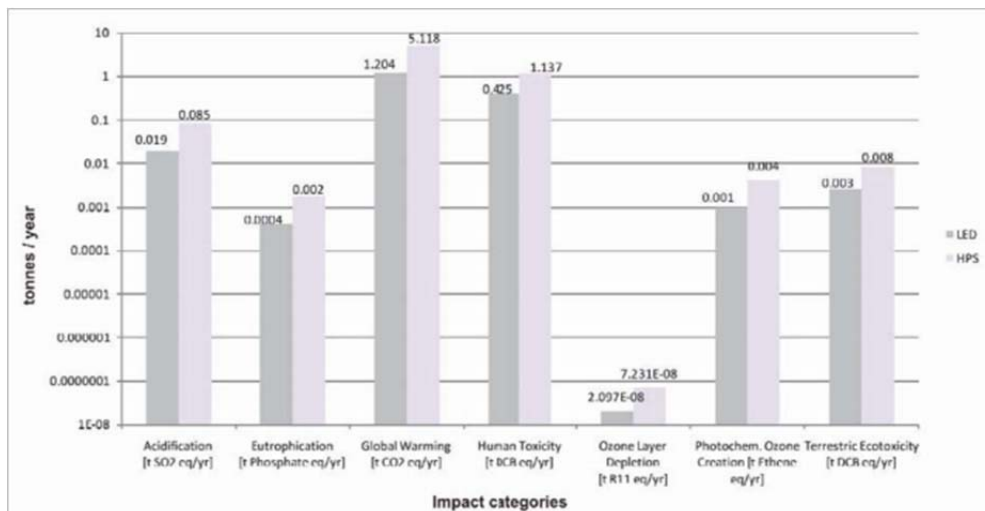

Diagram 4: Impacts comparison, HPS vs LED  
HPS: High- Pressure Sodium

## 1.4.2 Social and rural impact

### Energy security

The photovoltaic installation presented contributes to improved energy security by having a positive impact on rural electrification, energy autonomy and sovereignty.

- Rural electrification: The installation carried out can generate electricity in a rural area where there is no main grid, and the cost of extension and connection of the network represents a major investment.
- Energy independency and sovereignty: The installation that contributes to decentralized energy production contributes to energy supplier independence and autonomy. Also, this type of installation affects the direct control of the generation and energy consumption that affects greater autonomy.

The change in the intensity of the publicity parallels the public expansion of infrastructure, professionalization and structural changes.

The public impact is likely to be vast thus the development of positive attitudes is now indispensable. In addition to interaction based on social connections to the public is also effective to increase, but less than the strength of inquiries related decision making at the result, that "a relatively small -" privileged "or" medium-sized "- groups are more efficient than large ones.

Local governments have a greater impact on the population. During the development of a municipality much will depend on the decision-makers, city managers, local networks, stakeholders' interests, and personal competences.

Controlled system:

An intelligent network of street lights spread out across a city or town also offers communications improvements. Systems which can assist with many of the normal functions of a living city, including parking and traffic flow, are available. Street lighting systems can monitor traffic flow, and offer alternative routing based on weather, construction and changes to traffic signal timing. Intelligent street lights can also monitor air quality and other environmental conditions to improve information flow and enable municipalities to take action to benefit the lives of their citizens. Intelligent lighting systems can also improve the emergency response to dangerous developments by assisting with traffic control, providing information about the location of an incident and reducing response time.

<b>Designation of social indicators</b>	<b>Expected effects</b>
Human health	Minimal effects (see detailed in life-cycle analysis)
Quality of life	Due to the sense of independence for the supply system, no or minimal effect
Education, qualification, knowledge	Positive effect, involvement of students into research tasks for the purpose of disseminating results
Public awareness, approach, presenting good examples	Positive
Mitigation of social disparities	Negative impact: Access to PV systems is possible mainly for wealthy people and savings resulting from the use of such systems also contribute to their costbenefits, thus creating possibility for a further increase in social disparities
Enhancement of co-operation between social actors, strengthening cohesion	Positive impact: see e.g. outputs of current IPA
Prevention of migration (job creation)	Exerting no impact: the job-creation effect of PV systems does not appear in the given region (see detailed in the chapter about regional impacts)
Energy poverty alleviation	Positive impact: renewable energy is not yet fully exploited but it is gradually becomes incorporated in the energy system

Table 5: The effects of social and rural impacts

As we can see in Table 5 the potential social impacts are various. We can find factors where PV use has not or negative influence on the society, especially in the mitigation of social inequality. However it can positively affect cooperation. In a widely social sense the use of PV combined with good cooperation among actors can become a good-example, having positive effects on settlement marketing.

## 1.5 Conclusions

The photovoltaic LED lighting systems in most countries are in developing stage from the point of view of infrastructure and economics, but the prices are getting reasonable as the market demand rises higher for this kind of technologies, which make it more affordable. LEDs lamps have a longer lifespan, up to 50,000 hours. This is approximately 50 times longer than the classic incandescent bulb and 10 times longer than the compact fluorescent lamps. Used 10/12 hours a night, a LED module can approximately last up to 11 years.

This project of intelligent streetlight system is a cost effective, practical, eco-friendly and the safest way to save energy. It efficiently saves the energy by replacing the conventional bulbs by LEDs and by automatic switching/dimming of LEDs as and when required. The main drawbacks of this system are the initial cost and maintenance. However, large scale implementation of this proposed system will definitely reduce the overall cost of the project by a great extent.

By using these approaches to develop an intelligent lighting system, a higher control and energy efficiency and also a more environmental friendly system can be obtained. The overall efficiency begins at the design with LEDs, compared with the classical lighting systems. At this point the lighting system energy consumption is significantly lower and with greater energy efficiency as the system functions only when it is needed.

Intelligent lighting control and energy management system is a perfect solution for energy saving, especially in public areas.



## 1.6. References

### Internet resources

- [1] <http://www.sciencedomain.org>
- [2] <http://www.eordogh.hu>
- [3] <http://www.light.fi/blog/different-dimming-types-for-led-lighting/>
- [4] <http://www.ledsmagazine.com/index.html>
- [5] <http://www.sepco-solarlighting.com>
- [6] <http://www.enlighten-initiative.org>
- [7] <http://re.jrc.ec.europa.eu/pvgis/apps4/URpvest.php>

### Article/book resources

- [8] Guidelines for Sustainable Public Procurement/ LED Street Lighting Equipments- Marco Torregrossa, European Partners for the Environment- Brussels, 1 June 2010
- [9] Regional impacts of different photovoltaic systems- Published by: IDRResearch Kft.- 2014
- [10] Intelligent Street Lighting System Using Gsm, International Journal of Engineering Science Invention- K.Y.Rajput, Gargeyee Khatav, Monica Pujari - 2013
- [11] Dimming LED Lighting- AEG Power solutions- Dave Cooper- November, 2011
- [12] An Approach to Intelligent Road Lighting System with Renewable Energy Based Power Supply- Karoly Ronay, Cristian Dragos Dumitru- Romania, 2015
- [13] Photovoltaic System Design and Implementation Project Plan- Dr. Dionysios Aliprantis- May, 2008
- [14] Here is the future? Energy-efficient, intelligent public lighting system/ IV. LED Conference – László Babály, Gábor Czaha - Budapest, 2013
- [15] Guide to Cost-Benefit Analysis of Investment Projects/ Economic appraisal tool for Cohesion Policy 2014-2020/ December, 2014

### Online-course resources

- [16] Module 2- Chapter 1- part 1-3
- [17] Module 2- Chapter 2- part 1-2
- [18] Module 2- Chapter 2- part 2-3



# Calculations



**Compilation of case studies of applying renewable energies to local development transnationally implemented**



Co-funded by the  
Erasmus+ Programme  
of the European Union

## 2. Calculations and design

### 2.1 Size of the photovoltaic system

Measured by the autonomy of the solar photovoltaic system, it has an early pre-identification: the strength of the body, the height of the installation, and the pair of illuminating columns. In this stage the body size is shown as a user of electric energy in batteries.

In Romania the average length of the system in public lighting program is **4000** hours/year.

Certain aspects are likely to be criticised for instance that in winter when the photovoltaic lighting system is expected to work long hours the duration of sunshine hours is low.

Calculations are fully available on the site <http://re.jrc.ec.europa.eu/pvgis/apps4/URpvest.php> for Bacau production system using energy photovoltaic installed power of 1 kWp shows a daily average production of electricity for December is 1.37 kWh, at an angle inclination of 35°.

	Fixed system: tilting 35 grd. orientation: 0 degrees			
Months	Ed	EM	HD	HM
January	1,59	49,2	1,91	59,1
February	2,44	68,3	3,00	52,3
March	3,69	114	4,78	148
April	4,08	122	5,50	165
May	4,41	137	6,07	188
June	4,51	135	632	190
July	4,68	145	660	204
August	4,58	142	643	199
September	3,82	114	5,22	157
October	3,12	967	4,10	127
November	2,00	601	2,51	75,2
December	1,37	42,4	1,6	31,8
Year	3,36	102	4,52	137
Total one year		1230		1650

Table 6: The average quantity of electricity produced by photovoltaic system

The meaning of the notations is:

- $-E_d$  : average production of electricity daily from the given system (kWh);
- $-E_m$ : average monthly production of electricity (kWh);
- $H_d$  : average amount of daily global irradiation per square meter received by the given modules (kWh/m<sup>2</sup>);
- $-H_m$ : average amount of global radiation per square meter received by the modules of the system (kWh/m<sup>2</sup>).

Electricity demand for the LED lighting with an installed power of **50W at 24 V**, which function in Bacau in the shortest day in December between - 16.40 and 7:40 for 15 hours is 750 Wh.

Battery capacity (Ah = Wh/V) is calculated as follows:

$$C_a = C_s \times A / G_r \times T$$

where:  $C_a$  is the capacity of the battery in Ah;  $C_s$  - capacity electric power stored in the Wh; A-autonomy in days;  $G_r$  -the percentage of battery discharge; T-voltage in V.

In the case of regular use for photovoltaic lighting system, choose autonomy and a grade of 75% download result following capacity battery:

$$C_a = 750 \text{ Wh} \times 1 \text{ day} / 0,75 \times 24 \text{ V} = 41,6 \text{ Ah}$$

I have chosen 2 batteries of 30 Ah (12V)

As it was previously seen for a system of 1kWp photovoltaic panels with an installed power of 1kWp located optimally to the south at an angle of inclination of 35° produces daily and 1.37 kWh in our case we need 750 Wh. Therefore, give an installed power of the photovoltaic panels 547 Wp.

Optimization of the photovoltaic lighting system can be achieved by reducing the intensity of the **noase** (dimming) during the night, in the low-traffic times as shown in Figure 29.

In this period, changing to a lower class of enlightenment (in our case from the class ME4b) but with the standards related to the new lighting classes was framed.

Through this optimization the amount of energy used may be by lighting body by over 60% and thus reduce the cost of the photovoltaic system.

In our situation we can use a photovoltaic panel with 240 Wp.

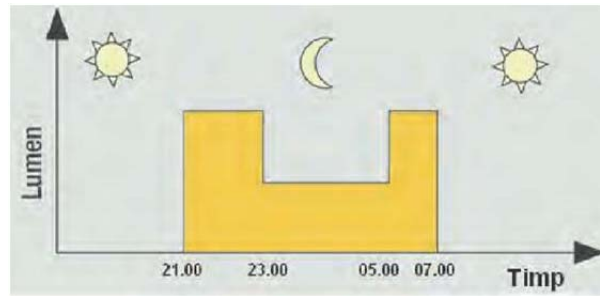

Figure 29: Periods identified in the course of the night to reduce the intensity of the bright part of the body.

From 21:00 till 23:00: 100% lighting mode → 5580 lm

From 23:00 till 5:00: 50% lighting mode → 2790 lm

From 5:00 till sunrise (7:00): 100% lighting mode → 5580 lm

Public lighting program is **4000** hours/year (avarage). One day:  $4000/365 \approx 10$  hours, but this data varies according to the seasons, but the avarage is 10 hours/day and I use this data in my calculations.

Without lighting control system: 4000h/year → lamps works at 100%.

With lighting control system, the lamps work between 23:00 and 05:00 (6 hours) at 50%. This in one year is: 2190 hours at 50%, which means that with a lighting control system we can save 1095 hours of lighting/per year from which, depending on the control system, tuning reduction also results. The 50% reduction of light in 6 hours/day results in a total of 27% reduction.

For the design and selection of a lamp type, an important criterion called lamp efficacy should be considered. In most cases, a more efficient light source can be substituted for a less efficient source with little or no loss in visibility or colour rendition. The total annual cost savings help to decrease the size of the photovoltaic system.

Lamp efficacy  $E_F$  is measured in lumens per watt (lm/W) and defined as follows:

$$E_F = F_L / P_L$$

where  $F_L$  is a luminous flux in lumen (lm) and  $P_L$  lamp power. Table 7 shows luminous efficacy of different types of lamps. If a lamp produces more lumens from each watt of electrical energy input, it is more efficient.

Lamp Type	Conversion Efficacy (Lumens per Watt)	Life (Hours)
Incandescent	14	800
Low Voltage Halogen	20	2000 to 5000
Mercury Vapor	40 to 60	22000
Fluorescent	64 to 90	7000
Metal Halide	70 to 90	12000
High Pressure Sodium	90 to 125	25000
Low Pressure Sodium	120 to 200	20000
LED Lamps	100 to 150	50000

Table 7: luminous efficacy of different types of lamps

$$E_F = 5580 \text{ lm}/50 \text{ W}$$

$$E_F = 111,6 \text{ lm}/\text{W}$$

The street has small vehicular and pedestrian movement at night, so selecting Illumination value ( $E = 4 \text{ lux}$ ) is enough based on the second classification in Table 9. The standard unit for illumination ( $E$ ) is lux, which is equal to  $\text{lm}/\text{m}^2$ .

Illumination E in (lux)	Environments
1	full moon
4-10	street lighting
100-1,000	workspace lighting
10,000	surgery lighting
100,000	plain sunshine

Table 8: Lux data

Road and area classification	$E_{ave}$ in (lux)
Local Residential Roads (Local-Low)	4
Residential Collector Road (Collector-Low)	6
Employment Collector Road (Collector-Low)	6
Arterial Roads (Major-Low)	9
Rural Local Residential (Local-Low)	4
Rural Collector Road (Collector-Low)	6
Low Density Residential	3

Table 9: Classifications of roads, and the lux values

The existing distance between two columns ( $a$ ) of the street about the Pegaso 36 type is 30 meters. Therefore,  $a$  should be selected 30 m in this study in order to use the same posts (columns). The street length: 150 m  $\rightarrow$   $150/30=5.5$  columns are need for adequate lighting.



# Budget and economic analysis





**Compilation of case studies of applying renewable energies to local development transnationally implemented**



Co-funded by the  
Erasmus+ Programme  
of the European Union

### 3. Economical aspects of the project

The full economic value of the investment required for a LED lighting project must be determined using standard analysis techniques. These devices are already widely used in industry to analyze energy efficiency and are easy to apply to LED lighting. Calculations are based on a life cycle analysis and provide a more realistic assessment of the long-term economic value of the LED lighting system.

LED lighting systems have a very long service life of over 50,000 hours, and new challenges for maintenance are new for local governments. Overall, significant cost savings can be achieved in maintenance operations, so LED luminaires will no longer require frequent bulb replacement, which is otherwise required for conventional light bulbs. This is somewhat offset by the more frequent cleaning of the lamps, which can be particularly needed in places where there is great contamination. Intelligent LED lighting can self-test: self-regulation can have a significant impact on the lighting network maintenance as it enables the automatic notification of the luminaire in case of faults.

The costs of the proposed system include the initial costs of the components, and components replacement costs, while the system maintenance costs should be done by the department of electricity in Margineni municipality. The existing hanging columns will be used for the proposed system. Initial costs include PV modules, batteries, charge controllers, lighting units and other accessories used in the installation. The life cycle period of the system is taken to be the life cycle period of the component that has a maximum life time. In this analysis, it is 24 years for the PV system. The life time of the battery is dependent mainly on number of charge-discharge cycles which in turn depends on value of depth of discharge of the battery (DOD) assumed. In this analysis a typical value of 12 years is considered as a life time of battery where a DOD is assumed to be 80%. The lifetime of the used LED lamps are 12 years on the basis of 10 hours of operation per night.

The life times of the other components of the system such as charge controllers and management system generally take values greater than 20 years. Because the cost of each is small in comparison with the other components, in this analysis a 24 years life time is considered for each. Therefore, batteries and lamps should be replaced once during this period.

### 3.1. Budget of the installation

The installation price proposed for the photovoltaic system (1 set) with the proposed elements (the prices are realistic):

Components	Costs
Solar Panel	€400
Charge Controller	€100
Battery (2x)	2x€700
Led lamp	€200
Remote Control	€200
Accessoires	€200
<b>Total cost (1 system)</b>	<b>€2500</b>
<b>Total cost for the whole street</b>	<b>5x€2500 = €12500</b>

Table 10: The price of the components

On the street, which is the main character in my case study, today has no lighting system. I start from a comparison of a traditional grid connected electric power and solar power system, which shows the difference from a financial point of view.

Used data:

- Lamps power: 100W; 50W
- Night hours: 10h; 7h
- Price of energy in Romania: €0,097

A normal high pressure sodium fixture's power for street lighting is 100W

5 fixtures are needed for the street:

$$5 \times 100W = 500W = \mathbf{0,5kW}$$

With effective night hours of 10h, the total annual consumed energy is:

$$365 \text{ night/year} \times 10 \text{ h/night} \times 0,5 \text{ kW} = \mathbf{1825 \text{ kWh.}}$$

Then, the annual total cost of the consumed energy is:

$$1825 \text{ kWh} \times 0.097 \text{ Euro/kWh} \approx \mathbf{€177.}$$

The power of the proposed LED lamp (Pegaso 36) is 50W

5 fixtures are needed for the street:

$$5 \times 50W = 250W = \mathbf{0,25kW}$$

With effective night hours of 10h, the total annual consumed energy is:

$$365 \text{ night/year} \times 10 \text{ h/night} \times 0,25 \text{ kW} = 912,5 \text{ kWh.}$$

Then, the annual total cost of the consumed energy is:

$$912,5 \text{ kWh} \times 0.097 \text{ Euro/kWh} \approx \mathbf{€88,5.}$$

This data was calculated without using the control system.

With an average reduction in brightness per night, not 10 hours/night, just 7 hour/night:

$$365 \text{ night/year} \times 7 \text{ h/night} \times 0,25 \text{ kW} = \mathbf{638,75 \text{ kWh}}$$

$$638,75 \text{ kWh} \times 0,097 \text{ Euro/kWh} \approx \mathbf{€62}$$

The price of a normal high pressure sodium fixture is about €800, which is much cheaper than the photovoltaic LED system (2500Euro), but the energy used by the normal system is more, which is an important aspect of the environment and economics.

Installing a photovoltaic system for the street instead of the current existing one according to Table 10, the total cost of the proposed system is (€2500). Therefore, the proposed lighting system of the Street is an economical one comparing to the annual total cost of the consumed energy of the traditional lighting system.

	<b>Traditional system</b>	<b>Photovoltaic controlled system</b>
1 piece	€800	€2500
5 piece	€5600	€12500
Energy price/year	€177	€62
Maintance/year	€80	€15
Total cost in the 1 <sup>st</sup> year	€5857	€12577
Total cost in the 2 <sup>nd</sup> year	€257	€77

Diagram 5: Recovery diagram

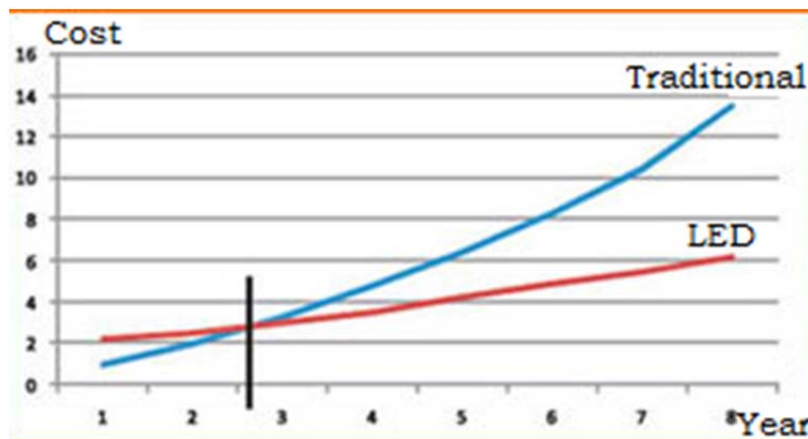

Table 11: Compraison of prices



**Compilation of case studies of applying renewable energies to local development transnationally implemented**



Co-funded by the  
Erasmus+ Programme  
of the European Union



# Project plans



**Compilation of case studies of applying renewable energies to local development transnationally implemented**



Co-funded by the  
Erasmus+ Programme  
of the European Union

#### 4.1. Location of the installation



Designer	Dora Okos			STUDY CONCERNING OPTIMIZATION OF PHOTOVOLTAIC LIGHTING SYSTEM IN MARGINENI VILLAGE	
Drawer	Dora Okos			LOCATION PLAN OF THE INSTALLATION	
				PLAN NR.1	



## 4.2. Distribution plan

The location of the system on the street.

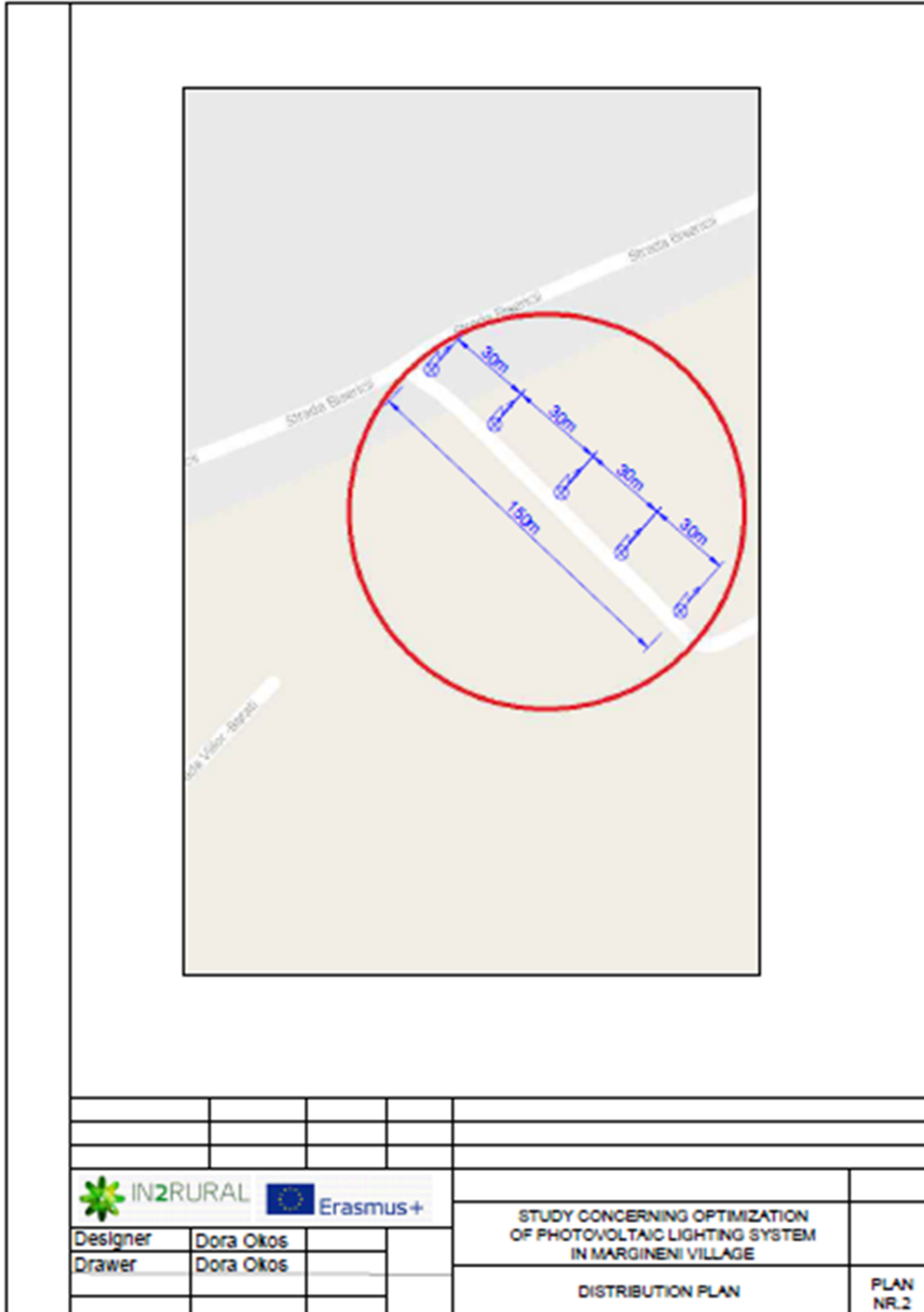

Photovoltaic lighting system plan

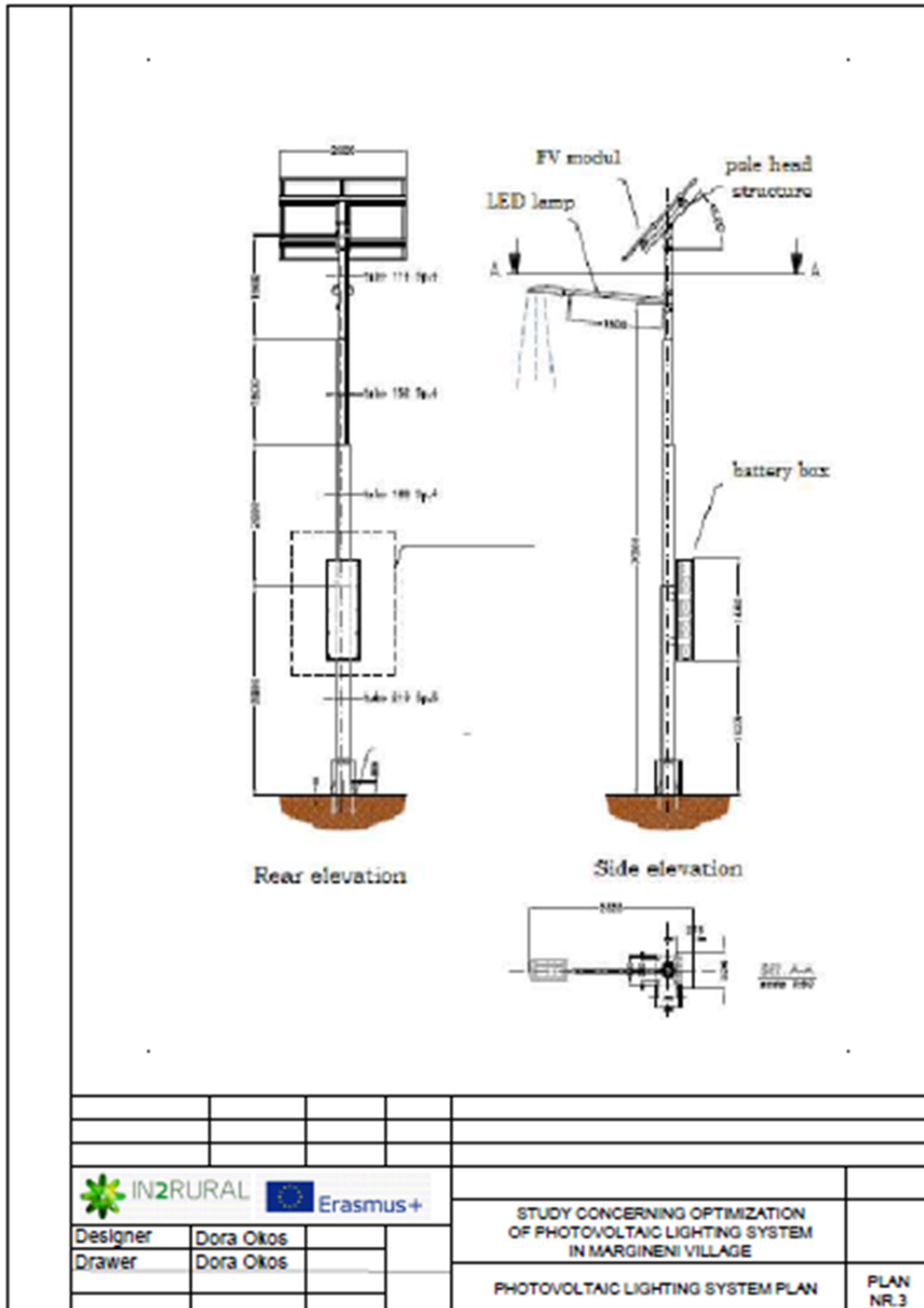

### 4.3. Electric scheme of the installation

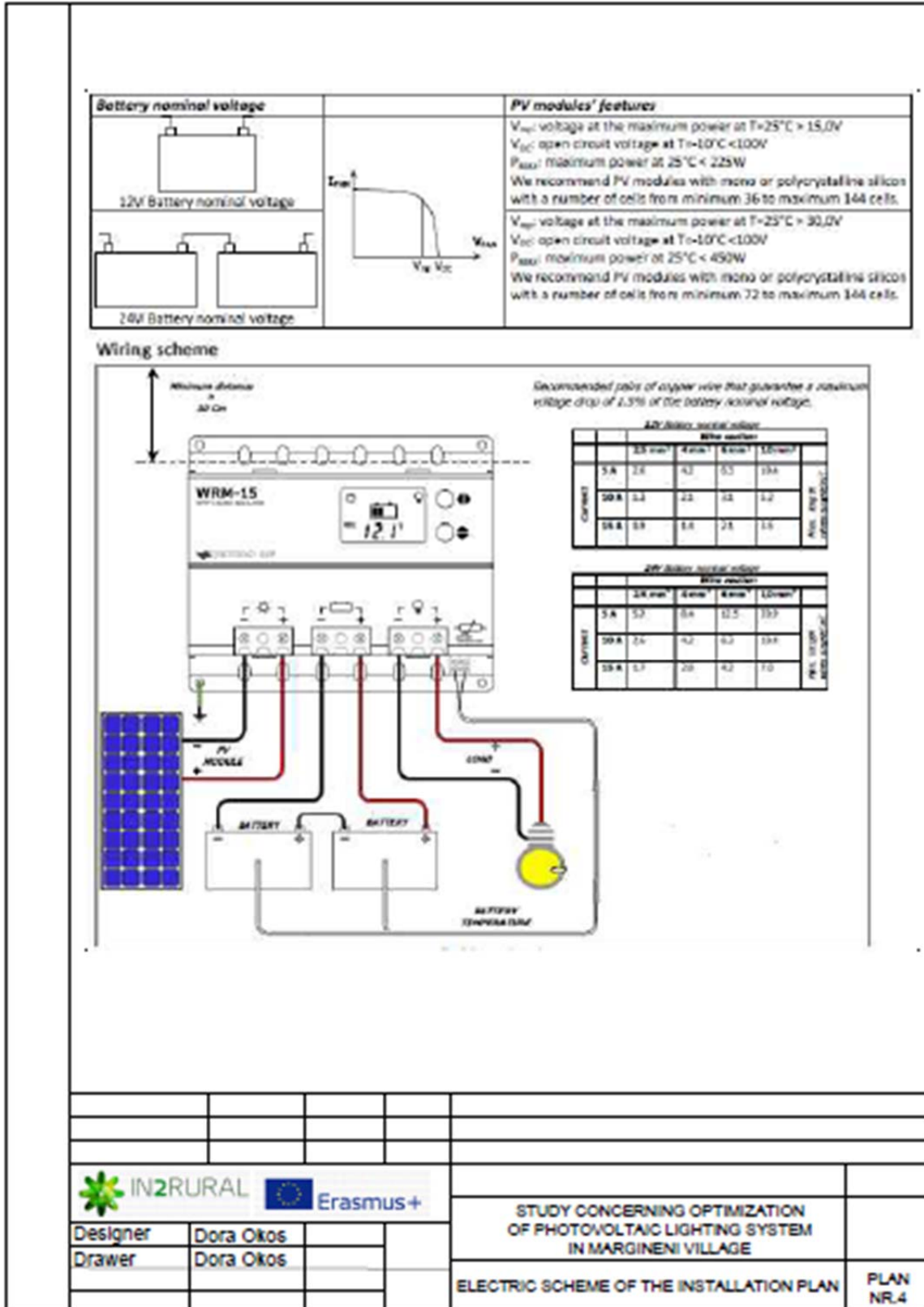

#### 4.4. Structure plans of the Elements/illuminated area

The structure of the LED Lamp

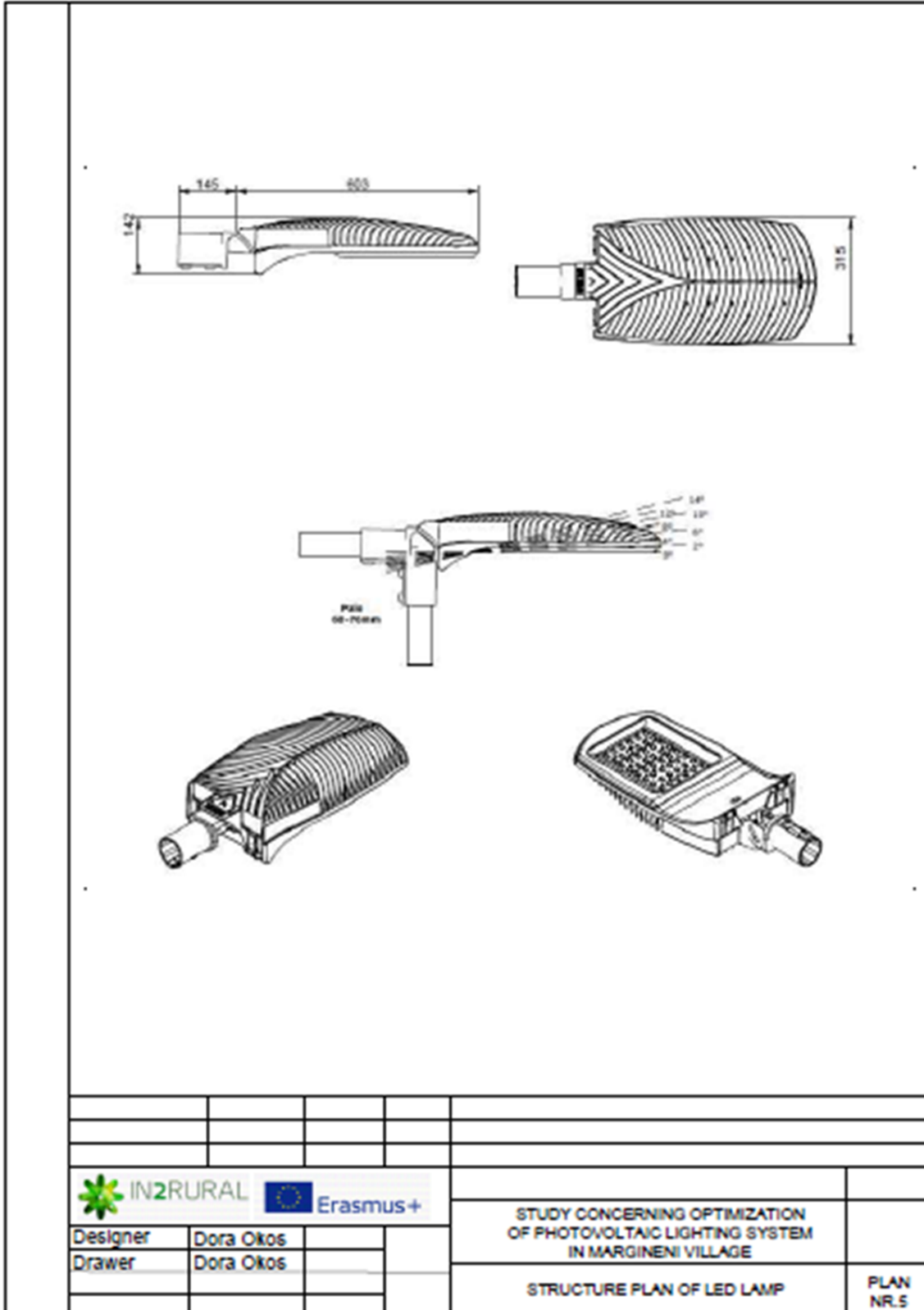

Structure of the Solar panel

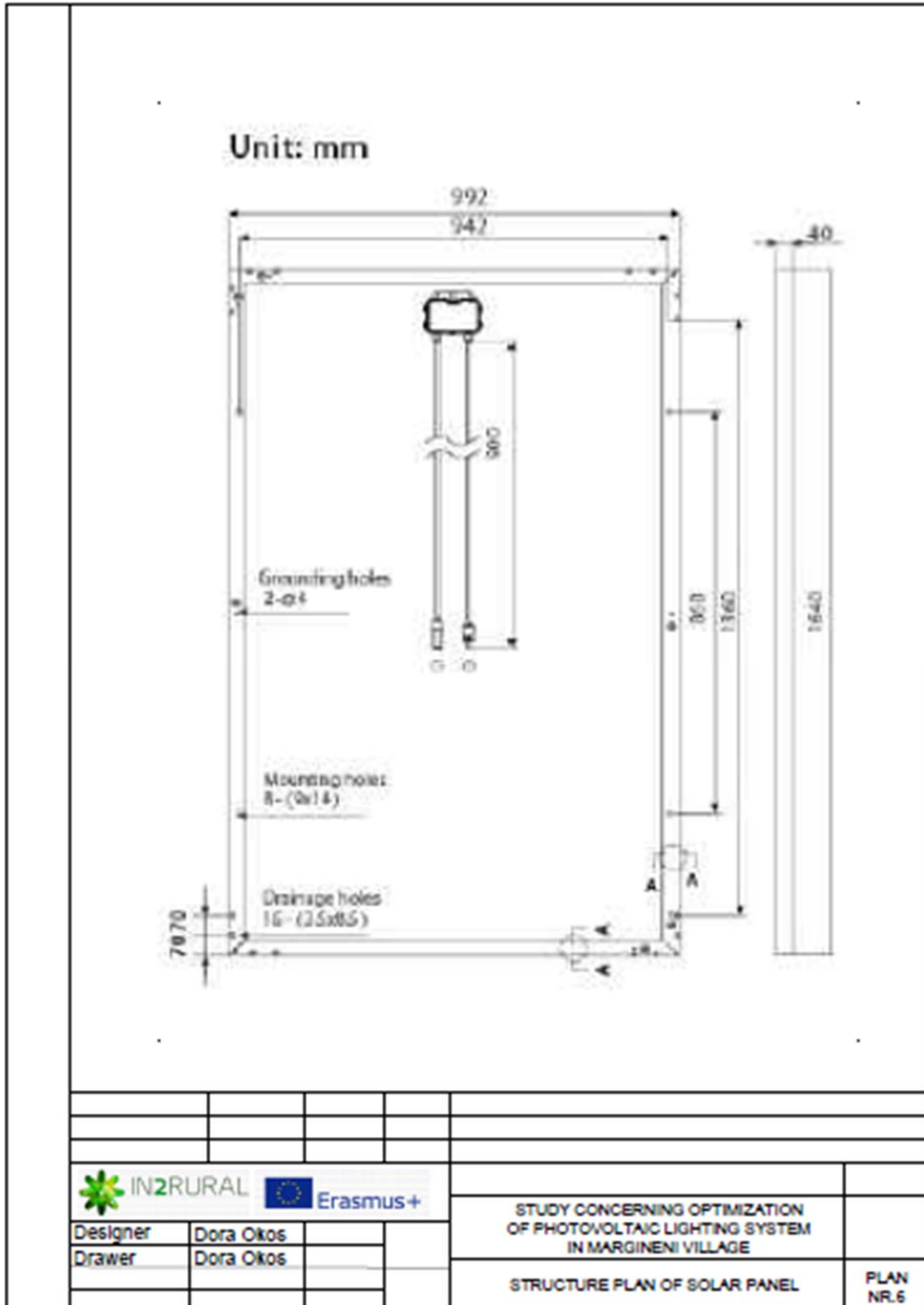

Plan of illuminated area

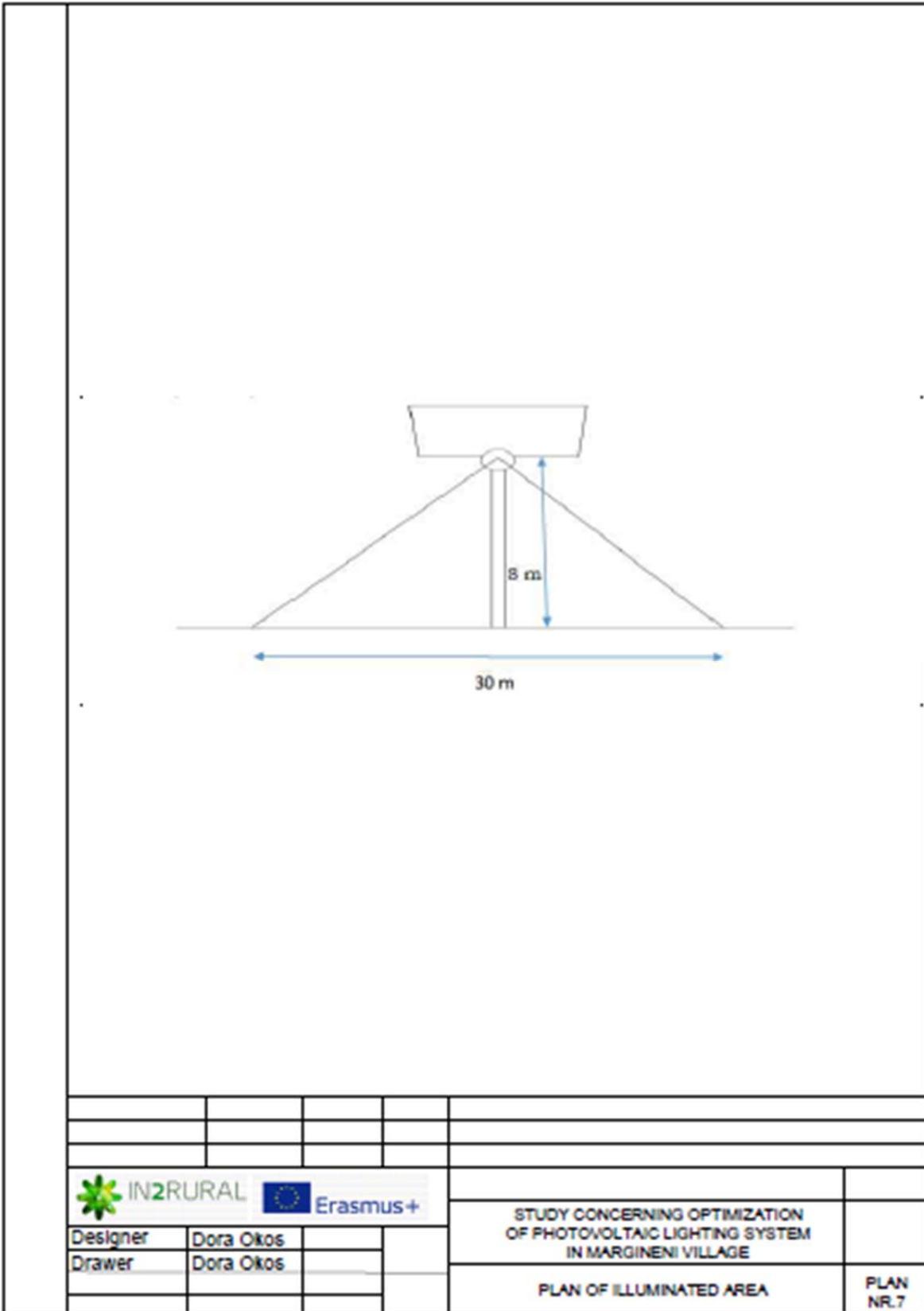



**Compilation of case studies of applying renewable energies to local  
development transnationally implemented**



Co-funded by the  
Erasmus+ Programme  
of the European Union









**Compilation of case studies of applying renewable energies to local  
development transnationally implemented**



Co-funded by the  
Erasmus+ Programme  
of the European Union



REPORT OF THE CASE STUDY ON RENEWABLE ENERGIES TO LOCAL  
DEVELOPMENT TRANSNATIONALLY IMPLEMENTED

# Development of renewable energy models for children education

Vivien Balog, EKU  
Jose Segarra Murria, UMANS  
Zsuzsanna Kray, UMANS

Case study tutor: Carmen Ibáñez Usach

Renewable energies tutor: Jose Segarra Murria

Rural development tutor: Vicent Querol

English tutor: Imre Baják

Professional supervisor: Zsuzsanna Kray

UMANS  
Castellon de la Plana, April 2017



IN2RURAL

**Compilation of case studies of applying renewable energies to local development transnationally implemented**



Co-funded by the  
Erasmus+ Programme  
of the European Union

# Index

<b>A. Memory of the project</b>	<b>5.</b>
<b>1. Introduction to the project (Vivien Balog)</b>	<b>7.</b>
<b>1.1. State-of-art in the problem domain (Vivien Balog)</b>	<b>10.</b>
<b>1.2. Design alternatives to be considered (Vivien Balog)</b>	<b>14.</b>
1.2.1. Electric power generation from hydraulic sources	11.
1.2.2. Electric power generation from eolic sources	31.
1.2.3. Electric power generation from photovoltaic sources	41.
<b>1.3. Description of three new models (Vivien Balog)</b>	<b>52.</b>
<b>1.4. Impact of the project on the rural development</b>	<b>53.</b>
1.4.1. Environmental impact (Vivien Balog)	53.
1.4.2. Social and rural impact (Vivien Balog)	55.
1.4.3. Pedagogical guide (Zsuzsanna Kray)	56.
<b>1.5. Conclusions (Zsuzsanna Kray)</b>	<b>68.</b>
1.5.1. Conclusion on pedagogical guide	68.
1.5.2. Conclusion on calculations	68.
1.5.3. Conclusion on Construction guide	68.
1.5.4. Conclusion on Economical calculations	68.
<b>1.6. References (Vivien Balog and Zsuzsanna Kray)</b>	<b>69.</b>
<b>B. Calculations &amp; construction guide (Z. Kray and J. Segarra)</b>	<b>73.</b>
<b>2.1. Calculations and design (Jose Segarra)</b>	<b>75.</b>
2.1.1. Calculation of Domestic Water Heater systems	75.
2.1.2. Calculation of Photovoltaic systems	78.
2.1.3. Calculation of wind turbine systems	81.
<b>2.2. Construction Guide</b>	<b>88.</b>
2.2.1. Domestic Water Heater Mock-up	88.
2.2.2. Photovoltaic Energy in Domestic Lighting	99.
2.2.3. Aeroelevator	109.



<b>C. Budget and economic analysis of the project (Z. Kray)</b>	<b>115.</b>
<b>3. Economical aspects of the project</b>	<b>117.</b>
3.1. Budget of the workshops	117.
3.2. Price variations	118.
3.3. Payback, IRR and NPV	118.
3.4. Time management	119.
3.5. Salary calculations	119.
3.5. Conclusions and future plans	120.
<b>D. Project plans (Zsuzsanna Kray)</b>	<b>133</b>

Memory of the project



IN2RURAL

**Compilation of case studies of applying renewable energies to local development transnationally implemented**



Co-funded by the  
Erasmus+ Programme  
of the European Union

## 1. Introduction to the project

This case study concentrates on children education on renewable energies.

There are a lot of renewable energy sources but this case study focuses on three main types.

In this case study, three models will be designed and their respective pedagogical guides will be prepared. Firstly, three different types of models will be analysed: hydraulic energy, eolic energy and photovoltaic energy each of them focused on a type of energy transformation process.

For each model selected from the literature reviewed, different features will be presented and studied: an initial design of each model will be included, the materials and components needed will be listed, a description of the process will be done and, finally, the steps to build it will be explained.

Finally, three new models will be designed concerning three types of energy transformation (hydraulic, eolic and photovoltaic energy).

As published by Kandpal and Broman [1]: “Another dimension of energy education, in general, and renewable energy education, in particular, that merits immediate attention is to ensure continuity and consistency in the inputs given at different levels.”

Due to the relevance of energy education, focus on energy education is a matter of high priority.

In order to make renewable energy sources be a big part in the global energy supply mix, large scale dissemination of different types of renewable energy technologies are needed.

It follows that the number of well-trained specialists who design, develop, repair, install, manage, and reserve renewable energy systems is increasing.

Large scale renewable plants (such as electric power generation using solar, wind, waves, tides, ocean thermal gradients, mini hydro, etc.) provide employment opportunity similar to conventional power plants.

Therefore, to meet the labour requirement of both the above types of potential renewable energy applications, it is essential that educational efforts in this area should take the job requirement of both types of applications into account.

So the renewable energy education is very important to provide trained manpower for huge energy systems is available along with skilled entrepreneurs for planning, development and treatment of renewable energy based decentralized systems. This way these energy systems are available along with skilled entrepreneurs for planning, development and treatment of renewable energy based decentralized systems.

This section includes precedents of this project. The development of renewable energy technologies has been emphasized in many countries previously. The main goal is to promote development. These energy supply opportunities will be very important in the future to face the global energy demand. Significant progression has been done in numerous technologies such as: photovoltaic and thermal applications, wind power, etc. in mid nineteen seventies. In turn, the total contribution of non-hydro renewable energy technologies is restricted yet.



In the last three decades, many education programmes have started whose topic is to promote the use of renewable energy in several countries worldwide. After the oil crisis of the nineteen seventies, a huge number of countries commenced academic projects in the field of renewable energy because many people worried about global climate alteration, and demanded the development of different renewable energy technologies. In that sense, huge progress was made related to these energies in, children education and energy training programmes.

Thus, as referred by Kandpal and Broman [1]: “The role of a renewable energy education programme should be educative, informative, investigative and imaginative. Renewable energy teaching and more broadly the energy tuition has to have the entire population as its target audience.”

It is essential to create the awareness of future generations in order to enhance the relevance of protecting the environment, energy related challenges are perceived by humanity (for example: climate change problems, and that high prices and the depletion of fossil fuels, etc.). It is necessary to make students be aware of the disadvantages of the different non-renewable sources and of the advantages of renewable energy sources, and also to inform them about renewable energy technologies and the institutional and environmental issues related to their development and utilization.

It is important to encourage children, and to focus on the enforcement and development of several ways to create energy solutions, make a lot of efforts towards the use of renewable energies. The world needs more and more energy, rising global energy postulate which has to be fulfilled. Furthermore, it is essential to focus on efficient and effectual applying of renewable sources of energy.

Renewable energy education in schools will have to be issued at mass level on a global scale. Therefore, both formal and informal ways of tuition should be substantially applied for this goal.

The formal education involves in direct communication (face to face), and commands given in universities, schools, colleges and so on.

This is a long term controlled strategy which ensures necessary skills knowledge through an organized system of education.

The informal mode means that the use of mass communication media to learn from institutions which do not impart organized instructions.

This mode helps to such people who have never gone to schools, such people who would like to study and are interested in improving themselves, their skills and knowledge.

As pointed by Kandpal and Broman [1]:

“Thus a judicious mix of formal and informal routes of education will have to be used for imparting renewable energy education. Since the adoption of renewable energy technologies

requires active participation of common public, it is important to take initiatives that improve public understanding in this regard.”

The present energy educators main task is the apportion of appropriate education to students about energy related complex issues, furthermore, to stimulate them to ferret about corresponding solutions.

“Concerted efforts should be made to improve the knowledge and appreciation of school students about renewable energy sources and technologies.”

Kandpal and Broman mentioned in their book [1].

In the world a lot of groups labour school curriculum. For example, Victorian Solar Energy Council in Australia began a renewable energy education programme in different schools.

This education programme contains different packages created in this topic, which help experimental work. Packages involve different types of games and several activities about renewable energy. It is possible to build simple experimental devices.

A new course was launched at the Moscow Institute of New Technologies in Education.

Students should introduce design of energy systems and different development plans and should be able to follow this project.

Florida Solar Energy Centre in the United States of America, which plays an important role in the field of energy education at school level, has done significant work.

The renewable energy education programmes and suitable consciousness initiatives at school level are very impressive in changing the behaviour of the students.

The familiarization with the basics of renewable energy resources and technologies is very essential in the science curriculum of schools.

As regards to variety and flexibility: renewable energy education has to be imparted at several levels.

Appropriate quality and amount of teaching-learning resource materials should be done attainable at all levels of renewable energy education, in formal and informal programmes as well, furthermore, from elementary school level to university level.

The appropriate allocation of available resources (for example: materials, books, etc) is very important. The sharing of electronic audio-visual resource materials is easier between respective teachers than books from libraries.

[1]

It is quoted from Rietbergen J. and Hadjemian N. ‘s book [2]:

“Renewable energy technologiess are energy-providing technologies that utilize energy sources in ways that do not deplete the Earth’s natural resources and are as environmentally benign as possible. These sources are sustainable in that they can be managed to ensure they can be used indefinitely without degrading the environment (Renewable Energy Association, 2009).2 By exploiting these energy sources, RETs have great potential to meet the energy needs of rural societies in a sustainable way, albeit most likely in tandem with conventional systems.”

[2]



Renewable energy derives from natural resources such as sunlight, wind, rain, tides, watercourses, which are naturally replenished.

In 2006 renewable energy from all sources accounted for only about 8% of global energy production. Nuclear made up another 6% of global energy production. This left about 86% of global energy originating from fossil fuels, which were both non-renewable, and also the main reason of global climate change and a number of other, contrary impacts on the environment.

As it was written by Nemethy S., Dinya L., Gergely S. and Varga G.

“The production and use of renewable energy (with particular emphasis on bio-energy, solar power and wind energy) is the key for all aspects of sustainability, including economical viability. Agricultural lands occupy 37% of the earth's land surface. Agriculture accounts for 52% of methane and 84% of global anthropogenic nitrous oxide emissions.”

The reduction of harmful greenhouse gases is needed, the best way to reduce these gases is to replace the fossil fuels for energy processing by agronomical feedstocks (such as dung, crop residues and dedicated energy crops).

In agriculture it has a lot of opportunities to develop combined production structures which include organic, chemical-free crop production, the application of bio-energy forests and biological filters, the consumption of biologically cleaned waste water, free from heavy metals etc.

The goal is to decrease the global warming. The application of bio energy plants has a lot of advantages and positive effects. For example, if renewable energy from dedicated bio energy crops (such as biological filters) were used, it may help to increase the soil carbon sequestration. This way the dedicated bio energy crops could reduce the effects of global warming.

In this method complete ecological cycles can be created, which utilize all energy sources in an optimal way and minimize waste production.

[3]

### **1.1. State-of-art in the problem domain**

Renewable energy education is a comparatively recent issue.

In order to conclude that the educational efforts are effectual and successful, different issues must be properly answered.

The specialist who works in this field, needs appropriate knowledge and skills, furthermore, has to be creative and to be able to create corresponding solutions for special situations.

This area is new, so specialists have to be aware of their responsibility, furthermore, they should be able to create green solutions.

The environmental consciousness is increasing year after year. It is typical that all of the potential energy solutions are controlled in a severe way. They will have short- and long-term effects on sustainable development and environment considerations.

All the energy resource technology combinations would be environmentally sustainable, it is very important.

It is essential that children can learn on renewable energy education related to different energy resource-technology combinations which have environmental and ecological implications (which need appropriate inputs).

Environmental education creation is a key towards students. Children will be able to look for and find possible energy supply options which satisfy increasing global energy demand.

Huge efforts towards environmental education.

It would be good if the pupils could make proposals for useful measures towards minimizing the negative environmental impacts of the energy solutions chosen by the consumers.

This is very important because it is needed that appropriate inputs for equal environmental education and energy education are ensured in a synergistic manner.

The renewable energy education has another aspect the effectiveness of which needs attention for getting a suitable job.

According to Kandpal and Broman: “At present, particularly in the case of post graduate level programmes, it is being noticed that energy education programmes are not always able to attract the best talented students thus, to some extent, reflecting its employment potential.”

The unemployment and under-employment is a similar big problem too.

The renewable energy programmes and education offer a lot of job opportunities, therefore it is very necessary.

This programmes proffer self-employment to children.

In most of the renewable energy education programmes, the entire content in its entirety of breadth and depth is often not included.

Courses need to be optimized so that they contain both a broad range of information and an in-depth analysis of the information given.

For example, if a single introductory course (of about 45 contact hours) is expected to provide inputs on all different renewable energy sources such as solar, wind, hydro, etc., only basic concepts (knowledge and understanding level) could be introduced in the lesson and detailed treatment (designs, analysis, evaluation, etc.) may not be possible.

Consequently, even after efficient accomplishment of such a course the children are just aware of several possible technological options renewable for harnessing energy sources.

Unfortunately, students are not able to obtain competence for their design, production, achievement, evaluation, etc.

In the past, regrettably, it has caused problems. Knowledge of employees is not enough to work and make an appropriate, successful strategy for huge size sustainable dissemination of renewable energy systems.

In fact, unfortunately, in many cases, their efforts have resulted in distorted prioritization and non-judicious allocation of scarce resources and funds.

The analysis of the renewable energy courses and teaching programmes is guided by the expertise of available educators.

The dissemination and development of the corresponding renewable energy technologies, will need collaboration of experts and well-trained staff in the whole world.

Workforce development is one of the critical factors referring to renewable energy technology dissemination and development.

As pointed by Kandpal and Broman [1]:

“This necessitates that sincere efforts be made in the area of renewable energy education and training to provide the required technical manpower at all levels.”

As it was written by Kandpal and Broman [1]:

“Unavailability of human resource with required knowledge and skills is often identified as one of the key reasons for poor dissemination of renewable energy technologies.”

The traditional fuels are not able to produce modern energy services, for example mechanical power and electricity limits their capability to develop other aspects of life (it involves employment and children education).

Unfortunately, traditional fuels can not produce appropriate energy which would be usable. Therefore energy producing of traditional fuels is useless and ineffectual.

As a result of this, they need a huge efforts and also substantial time to gather. The local resource stocks frequently reduce so they should be derived from further outside.

As it was written in Rietbergen J. and Hadjemian N. ‘s book [2]:

“This significantly reduces the time available for productive activities. If managed ineffectively, such resources use can also degrade the environment and create negative spillover effects in other sectors. Given the cultural practices in many rural areas, these impacts are often most felt by women and children.”

Although, there are some methodological difficulties which create concrete connection between energy poverty and rural development. It is a common concept the name of which is “energy ladder”.

Societies that depend on traditional energy activities are placed at the bottom rung of the energy ladder.

The energy ladder is moved up by modern energy services.

The societies which have full access to modern energy services, they are found at the top of the energy ladder and experience superior levels of economic development and higher income levels.

[2]

Finnish rural schools have formed huge efforts to ensure educational equality in rural areas which have a considerable number of population.

Unfortunately, in the past several decades, a lot of rural schools have been closed in several countries. The reason was that these schools had high costs, furthermore, it was not so cheap to get along kids from very small town to bigger schools. It caused a significant problem.

Authorities decided to close rural schools. The small school involves just fifty pupils in this region. The children who are aged seven to twelve and one to six take part in primary school (or sometimes people define these preschools) in these rural areas. Usually there are few



teachers in the classroom in these small schools. This teaching has a special name “multigrade or multiage teaching”. [4]

Concrete details are referred from Hyry-Beihammer and Autti [4]: “In the last two decades, sixty-five percent of small Finnish comprehensive schools have been closed.

Many rural schools had serious financial problems.

From 1990 to 2010, 2,117 comprehensive schools were closed in Finland.”

Although, many rural schools have been closed, fortunately, new schools have been built in this region.

After World War II, the school-age population was extremely big, and the shipping process and routes were undeveloped yet. In the 1950s, towns in this area spread all over the municipalities. An unexampled growth in the number of village schools started, therefore, more new schools buildings were needed in this rural area.

Until the 1950s the number of schools frequently increased. [4]

The energy maintenance and the sequestration of carbon dioxide can go different ways to contribute to the solution of this problem, but the application of renewable energy sources must increase dramatically worldwide, in order to produce ecologically and energetically self sustaining societies. These societies are built on such a difficult system which involves ecological and inartificial progresses.

[3]

## 1.2. Design alternatives to be considered

### 1.2.1. Electric power generation from hydraulic sources

In this section, three models where hydraulic energy is transformed into electric energy are analysed which are developed for children.

#### 1.2.1.1. Electric power generation from hydraulic sources option 1.

##### 1.2.1.1.1. Initial design of the model

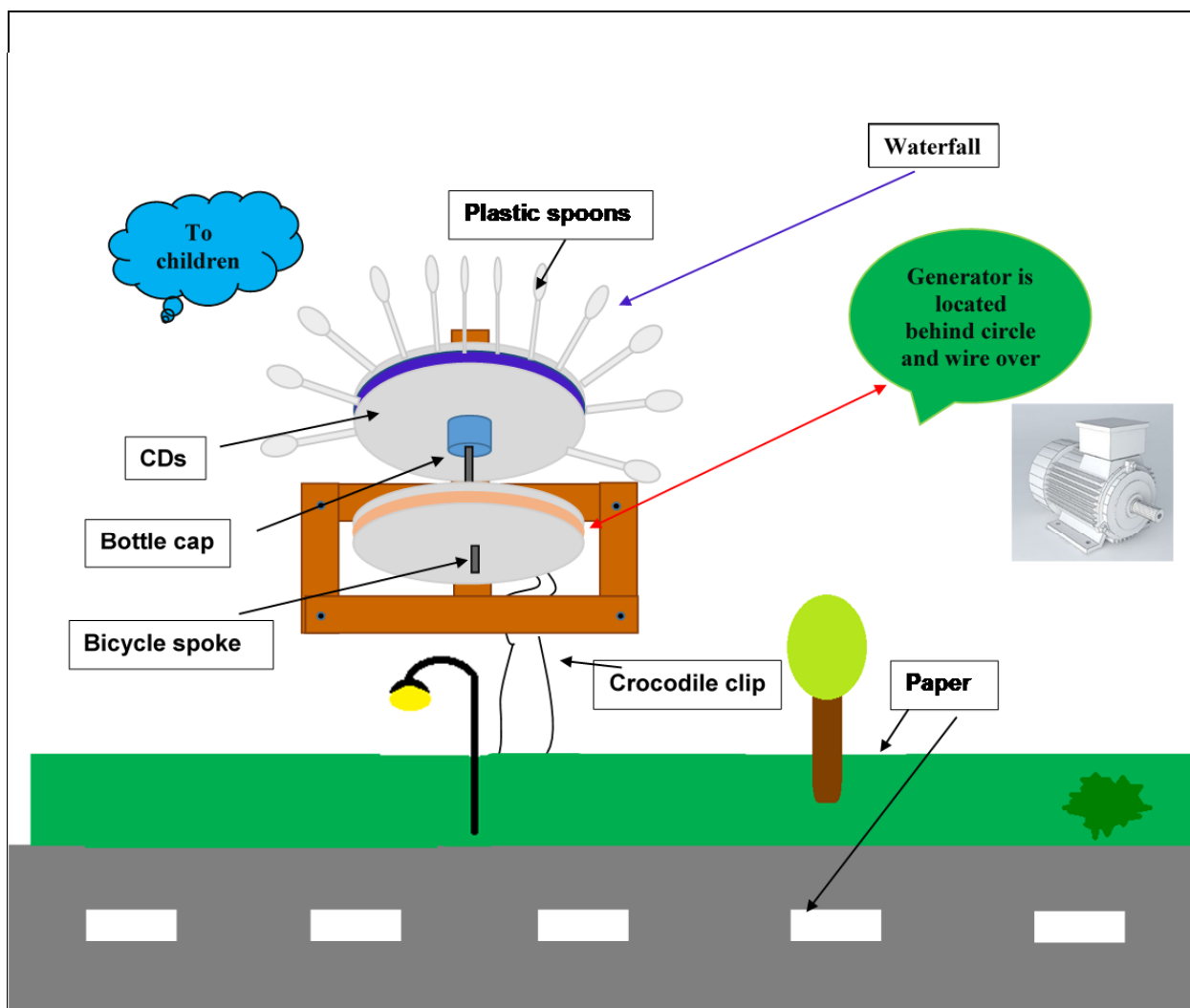







Figure 1. : H 1. Drawing

### 1.2.1.1.2. List of materials and components

**Table 1. : H 1. List of materials**

<ul style="list-style-type: none"> <li>• Two the biggest size woods (the same sizes)</li> <li>☛ Sizes: Length: 24 cm 2,5 cm wide 2 mm thick</li> <li>On the top of wood there is a hole which is of 2 mm diameter</li> <li>• Two medium sized woods (the same sizes)</li> <li>☛ Sizes: Length: 21 cm 2,5 cm wide 4 mm thick</li> <li>There is a hole in the middle of wood (also of 2 mm diameter)</li> <li>• Two small size woods (the same sizes)</li> <li>☛ Sizes: Length: 11 cm 2,5 cm wide 4 mm thick</li> <li>In this case: on the top of the wood and at the bottom part of wood there is a hole (also 2 mm diameter)</li> <li>These holes are located at 2 mm distance from the edge of wood.</li> </ul>	
<ul style="list-style-type: none"> <li>• Four CDs (Compact Disk)</li> <li>☛ Sizes: Diameter: 12 cm Thickness: 1,2 mm</li> </ul>	
<ul style="list-style-type: none"> <li>• One circular styrofoam</li> <li>☛ Sizes: Diameter: 11,5 cm Thickness: 3 mm</li> </ul>	
<ul style="list-style-type: none"> <li>• Bicycle spoke</li> <li>☛ Sizes: Length: 13 cm Diameter: 2 mm</li> </ul>	
<ul style="list-style-type: none"> <li>• Generator (motor)</li> <li>Twelve Volt motor worm</li> <li>☛ Sizes: Approximately 4cmx2cm</li> </ul>	
<ul style="list-style-type: none"> <li>• Two plastic bottle caps</li> <li>☛ Sizes: Outer diameter: 21 mm</li> </ul>	



Height : 16 mm	
<ul style="list-style-type: none"> <li>Sixteen disposable plastic teaspoons</li> <li>Sizes: Length: 14 cm</li> </ul>	
<ul style="list-style-type: none"> <li>Jar rubber (rubber band)</li> </ul>	
<ul style="list-style-type: none"> <li>Water shut-off valve</li> <li>Sizes: Length: 4cm Diameter: 0,8 cm</li> </ul>	
<ul style="list-style-type: none"> <li>Two crocodile clips (black and red)</li> <li>Sizes: Length: 20 cm</li> </ul>	
<ul style="list-style-type: none"> <li>LED diode</li> <li>Sizes: Approximate length: 3 cm</li> </ul>	
<ul style="list-style-type: none"> <li>Four small screw nails</li> <li>Sizes: Length: 1 cm</li> </ul>	
<ul style="list-style-type: none"> <li>Two longer screw nails</li> <li>Sizes: Length: 3 cm</li> </ul>	
<ul style="list-style-type: none"> <li>One two litre plastic bottle (with pouring water)</li> </ul>	
<ul style="list-style-type: none"> <li>Screwdriver</li> </ul>	
<ul style="list-style-type: none"> <li>Small piece of metal slab (platen)</li> <li>Sizes: Length: 4 cm Width: 2 cm</li> </ul>	
<ul style="list-style-type: none"> <li>Glue gun</li> </ul>	
<ul style="list-style-type: none"> <li>Superglue</li> </ul>	
<ul style="list-style-type: none"> <li>Decoration: Two straws (Height: 5cm), colourful papers (brown, black, green, pink), table tennis ball</li> </ul>	

<ul style="list-style-type: none"><li>• Artificial grass (width: 3 cm, Length:10 cm)</li></ul>	
<ul style="list-style-type: none"><li>• Sheets of wood</li></ul> Sizes: Length: 60 cm Width: 60 cm	

### 1.2.1.1.3. Description of the process

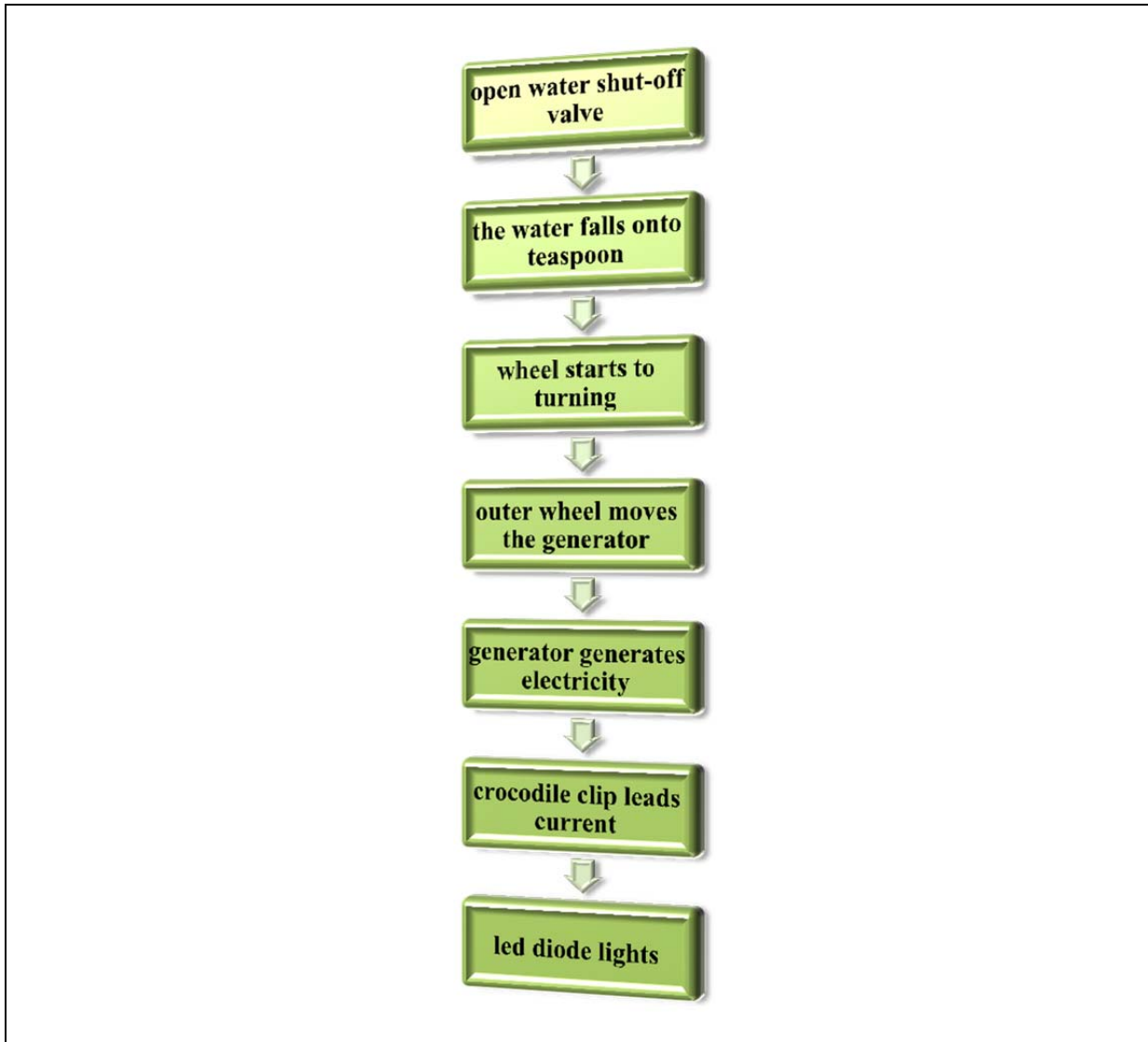

Figure 2.: The description of the process in a few words

#### 1.2.1.1.4. Steps to build the model

- Drill the holes in the wood pieces (diameter: 2 mm).
- Two pieces of small size wood (length: 11 cm) and two pieces of medium size wood (length: 21 cm) were screwed together in rectangle form with four small screw nails.
- Drill a hole in the two biggest size piece of wood (length: 24 cm) which was located 2 mm distance from the edge of the wood. Diameter: 2 mm
- One-one the biggest size wood (length: 24 cm) was screwed to (the middle) one-one pieces of the medium size woods (length: 21 cm) (with two longer screw nails).
- The lines (diameter) have to be drawn equal distance each other using a ruler. Exactly sixteen lines are drawn in CD.
- Use a glue gun to draw eight lines.
- Disposable plastic spoons have to be installed in sixteen pieces of glue streaks in the same direction.
- Glue has to suited in top of the disposable plastic spoons, and CD is laid into the spoons (softly push).
- Holes have to be drilled (diameter: 2mm) in the middle of the two plastic bottle caps.
- Glue has been suited in the inner edge of the two plastic bottle caps then it is put in the middle of the CD (so the top of the plastic bottle caps would be up), then glue is placed in the outer edge of the plastic bottle caps).
- Bicycle spoke has been attached to the wood and the plastic bottle caps (through propeller), use a superglue.
- We make sure that all things moving together with propeller. If it works, we can go on to the next step.
- Hole has to be drilled (diameter: 3mm) in the middle of the previous two CDs and the styrofoam.
- The two CDs and the styrofoam have to be stucked together (by superglue), the styrofoam was located in the middle, between the two CDs.
- The prepared object must be put to the bicycle spoke, it was fixed with superglue.
- Cut the unnecessary (pieces) parts of the bicycle spoke.
- The propeller was fixed by superglue, put the wood and into the bicycle spoke. This is necessary so that the propeller should not fall down. Then we turn this structure to check whether it works or not. It was excellent, so we continued.
- Put jar rubber between the two CDs and the styrofoam.
- Fixed the generator to wood with the platen (metal slab). Drilled two holes in the wood which will hold the generator (engine).
- The generator has a little black part (wheel), so put the jar rubber into the little black part of the generator. It will generate energy. Furthermore, needed two screws to put.
- Drilled a hole in the 2 litre plastic bottle which has the same diameter as the diameter of the water shut-off valve.
- Connected the crocodile clip to the generator, and the other part of the crocodile clip was connected to the led diode.



- Turned this wheel, the led diode lighted, so it created energy.

#### The decoration of this model:

- Lamp in the road: Lead a wire (crocodile clip) through black colour straw. The led diode was located on the top of the straw.
- The road: use big grey paper and cut streaks from white paper.
- Bush: fold a few green papers, and cut streaks and (glue gun).
- Hedgehog: cut black paper and pink paper (superglue).
- Tree: Big straw was bought (height: 5 cm), cut unnecessary part of straw. Cut a little brown paper and stick to the straw.
- Crown of tree: table tennis ball was bought (normal size ping-pong ball), and cut from green paper appropriate size piece, stick together the paper and the ball. Stick together the ball and the straw.
- Artificial grass which was 3 cm wide and 10 cm long.
- This model and decoration were located in cut sheets of wood (60x60cm) which was painted to green colour.

#### **1.2.1.1.5. Pedagogical explanation**

Fill the two litre plastic bottle with water. Open the water shut-off valve (this is a switch which enables the water to fall, otherwise it does not allow the water to fall) and see the water fall into spoons. This way, the propeller starts to rotate. As one of the wheels is connected to the generator it generates electricity. The crocodile clip is conducting the created electricity. Crocodile clip leads the energy to the led diode.

If the water falls frequently, the electricity is constant. Otherwise if the water falls discontinuously the electricity is not constant, the power generation is defective. [5]

### 1.2.1.2. Electric power generation from hydraulic sources option 2.

#### 1.2.1.2.1. Initial design of the model

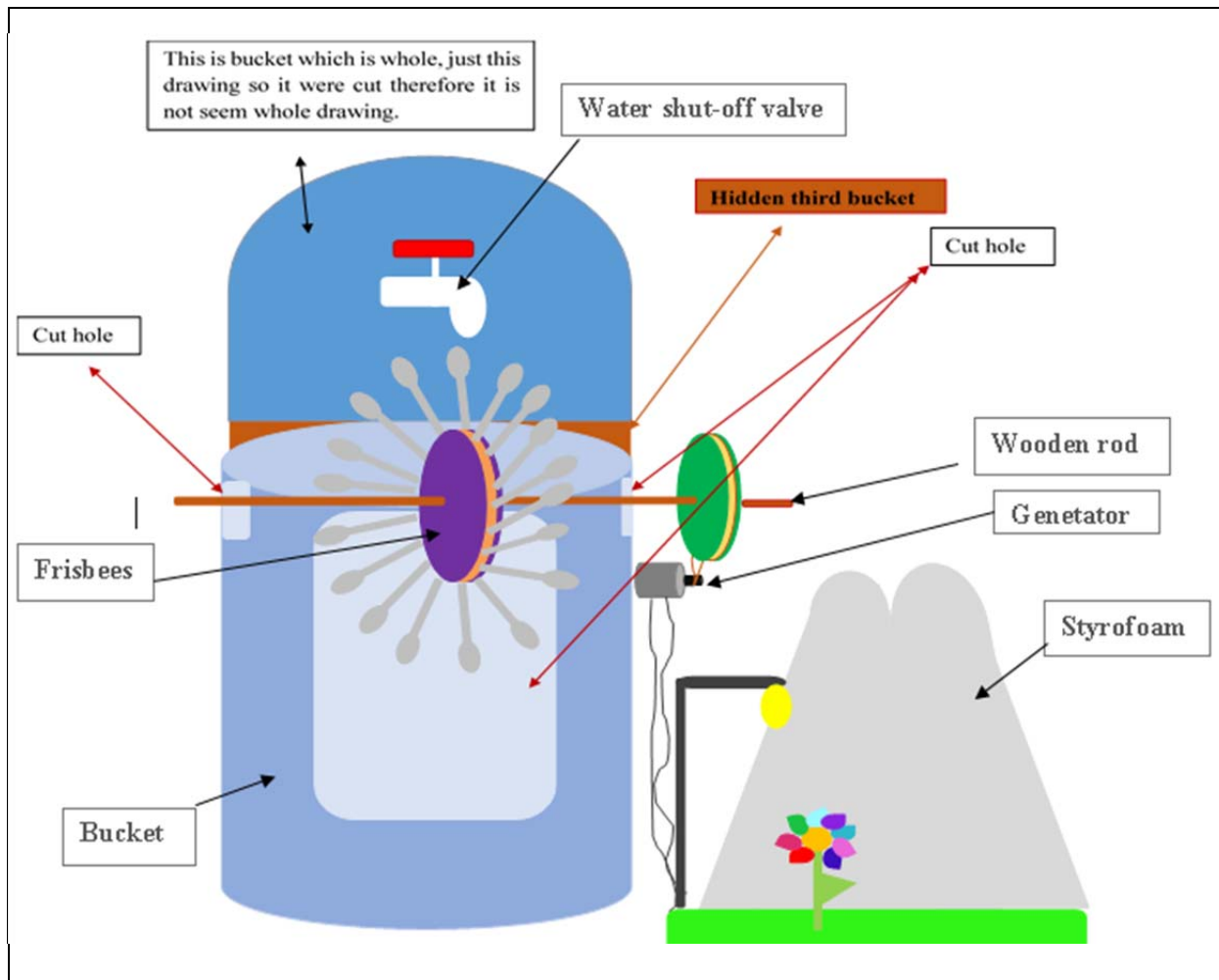

















Figure 3. : H 2. Drawing.

#### 1.2.1.2.2. List of materials and components

Table 2. : H 2. List of materials

<ul style="list-style-type: none"> <li>• Three plastic buckets</li> </ul> <p>Sizes: Tonnage: 20 litre Diameter: 35 cm Height: 33 cm</p>	
<ul style="list-style-type: none"> <li>• Water shut-off valve</li> </ul> <p>Sizes: Length: 2cm Diameter: 1 cm</p>	

<ul style="list-style-type: none"> <li>• Cylindrical wooden rod</li> </ul> <p>Sizes: Diameter: 2 cm Length: 45 cm</p>	
<ul style="list-style-type: none"> <li>• Corkwood (whose form is circular)</li> </ul> <p>Sizes: Height: 2 cm Diameter: 9 cm</p>	
<ul style="list-style-type: none"> <li>• Ten disposable plastic spoons</li> </ul> <p>Length: 6 cm</p>	
<ul style="list-style-type: none"> <li>• Two plastic frisbees (bigger)</li> </ul> <p>Sizes: Diameter: 9 cm Height: 0,5 cm <li>• Two plastic frisbees</li> <p>Sizes: Diameter: 6 cm Height: 0,5 cm</p> </p>	
<ul style="list-style-type: none"> <li>• Sponge (second circle)</li> </ul> <p>Sizes: Diameter: 6 cm Height: 2 cm</p>	
<ul style="list-style-type: none"> <li>• Rubber band</li> </ul>	
<ul style="list-style-type: none"> <li>• Crocodile clip</li> </ul> <p>Sizes: Length: 30 cm</p>	
<ul style="list-style-type: none"> <li>• Generator (motor)</li> </ul>	
<ul style="list-style-type: none"> <li>• Led diode</li> </ul>	
<ul style="list-style-type: none"> <li>• Bicycle spokes (cut small pieces)</li> </ul>	
<ul style="list-style-type: none"> <li>• A small piece of metal slab (platen) (curved, semi-circular form)</li> </ul> <p>Sizes: Length: 4 cm Width: 2 cm</p>	

<ul style="list-style-type: none"> <li>Two small screws</li> </ul> <p>Sizes: Length: 1 cm</p>	
<ul style="list-style-type: none"> <li>Superglue</li> </ul>	
<ul style="list-style-type: none"> <li>Glue gun</li> </ul>	
<ul style="list-style-type: none"> <li>Cut sheet of wood (base board)</li> </ul> <p>Sizes: Length: 100 cm Width: 100 cm</p>	
<ul style="list-style-type: none"> <li>Artificial grass</li> </ul> <p>Sizes: Length: 40 cm Width: 20 cm</p>	
<ul style="list-style-type: none"> <li>Colourful (green, yellow, red) papers</li> </ul>	
<ul style="list-style-type: none"> <li>Straw</li> </ul>	

### 1.2.1.2.3. Description of the process

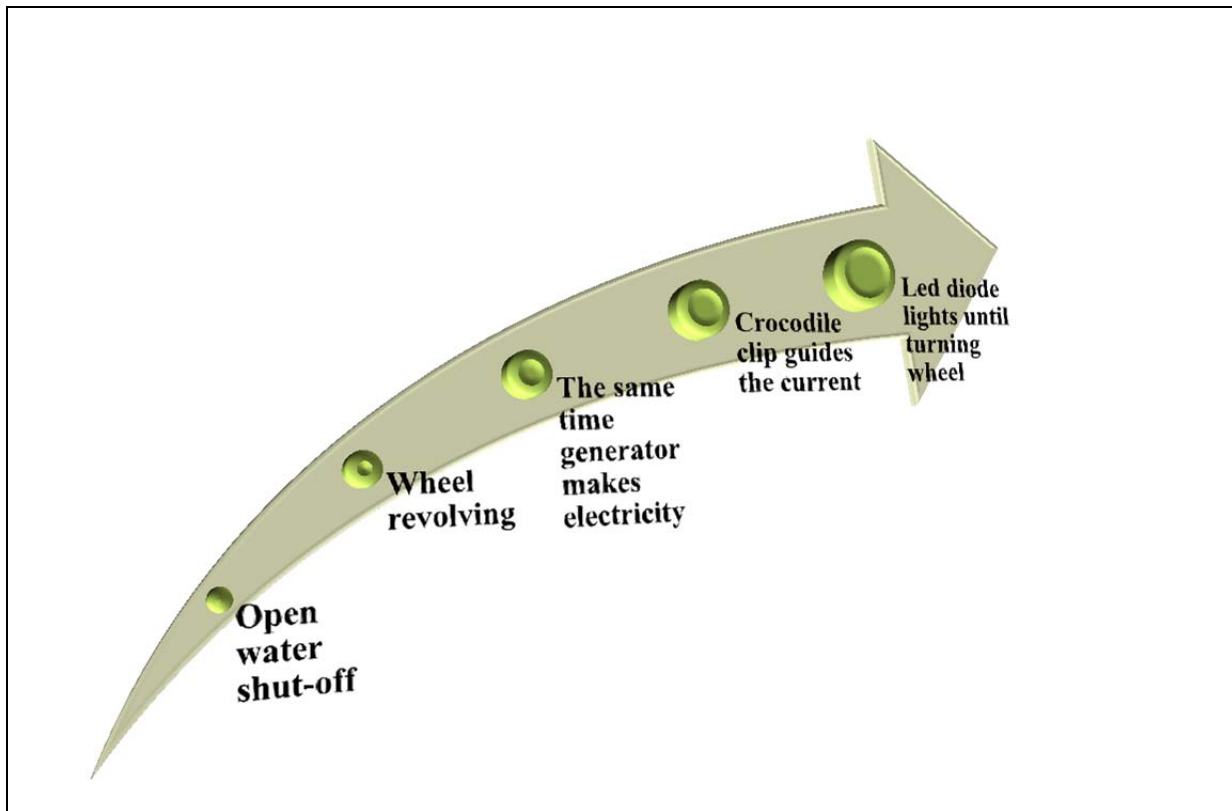

Figure 4.: The description of the process in a few words

#### 1.2.1.2.4. Steps to build the model

- Turn one of the plastic buckets (with head down) and put the second plastic bucket into this plastic bucket. Drill a hole (the diameter of which is 1 cm) in the side of the upper plastic bucket. Put the water shut-off valve into this hole. Use superglue to avoid it from moving. If this step is finished, fill the plastic bucket with water.
- Take out the third plastic bucket's ear because it is not necessary.
- Cut two holes in the middle of the plastic bucket. These two holes are placed symmetrically. The details of both of the holes are: 5 cm long, 3 cm wide. Both of the holes have the same parameters.
- The third hole bisects the two previous holes. Cut the third hole which is 20 cm long and 10 cm wide.
- Cut (use a knife or a similar appropriate device, a pencil sharpener drawing tool can even be used) the end of ten spoons to get a sharp form.
- The corkwood of circular shape has these dimensions: height: 2 cm, diameter: 10 cm. Insert ten plastic spoons to around the corkwood. Thrust into corkwood. The distance is 3,1 cm between the ten plastic spoons. Each spoon is 3,1 cm far from another spoon. Stick this structure between two pieces of frisbee together (use super glue).
- Also stick the sponge between two pieces of frisbee together. This is the circle which will be put in the jar rubber.
- As the cylindrical wooden rod has diameter (which is 2 cm), therefore a hole will be drilled (the diameter of which is 2,3 cm) exactly in the middle of the circular corkwood (first circle) and also drill a hole (diameter: 2,3 cm) in the middle of the second circle.
- If the previous step is completed, put this corkwood in the middle of the cylindrical wooden rod. Fix this structure with superglue.
- Drill a hole (diameter 2,3 cm) in the middle of the sponge.
- Also drill a hole (which also size is 2,3 cm) in the middle of the two pieces of frisbee.
- Stick the sponge between two pieces of frisbee (use superglue).
- Put the created second circle into one side of the wood, furthermore stabilize it with glue gun.
- Lay the cylindrical wooden rod with structures (with two circle) into the plastic bucket.
- Drill two holes (the diameters are: 0,4 cm) under the smaller circle. The distance between the holes are 2 cm.
- Fix the generator (motor) with a curved small piece of metal slab (platen) into the plastic bucket.
- Fix the rubber band (jar rubber) to the generator's small moving part, furthermore also fix it into in the middle of the smaller circle.
- Connect the crocodile clip to the generator.
- Lead the wire of the crocodile clip to the led diode under the artificial grass.
- Fix the led diode into the bicycle spoke (before we cut 5 cm long bicycle spoke), which will be painted black.





- Stick the end of the bicycle spoke and the base board together with superglue.
- The wooden base board is 100 x 100 cm.
- Artificial grass: Use superglue to stick together the artificial grass and the cut sheets of wood (base board).
- Flowers: create some flowers. Cut a short line streak from green paper and cut a circle from yellow paper and cut petals from different colour papers. Flower stalks: use straw (cut the unnecessary parts, length: 2 cm)
- Mountain: Use styrofoam painted in grey. Cut the styrofoam mountain form.

#### 1.2.1.2.5. Pedagogical explanation

The first step is to switch on the water shut-off valve. If the container is full of water, the water will start to flow.

When the water falls into plastic spoons, this wheel will start to turn.

The smaller circle is connected to the generator which generates electricity.

The crocodile clip plays one of the most important roles in this process because the crocodile clip leads energy to the led diode.

Consequently, the led diode starts to light. [6]

### 1.2.1.3. Electric power generation from hydraulic sources option 3.

#### 1.2.1.3.1. Initial design of the model

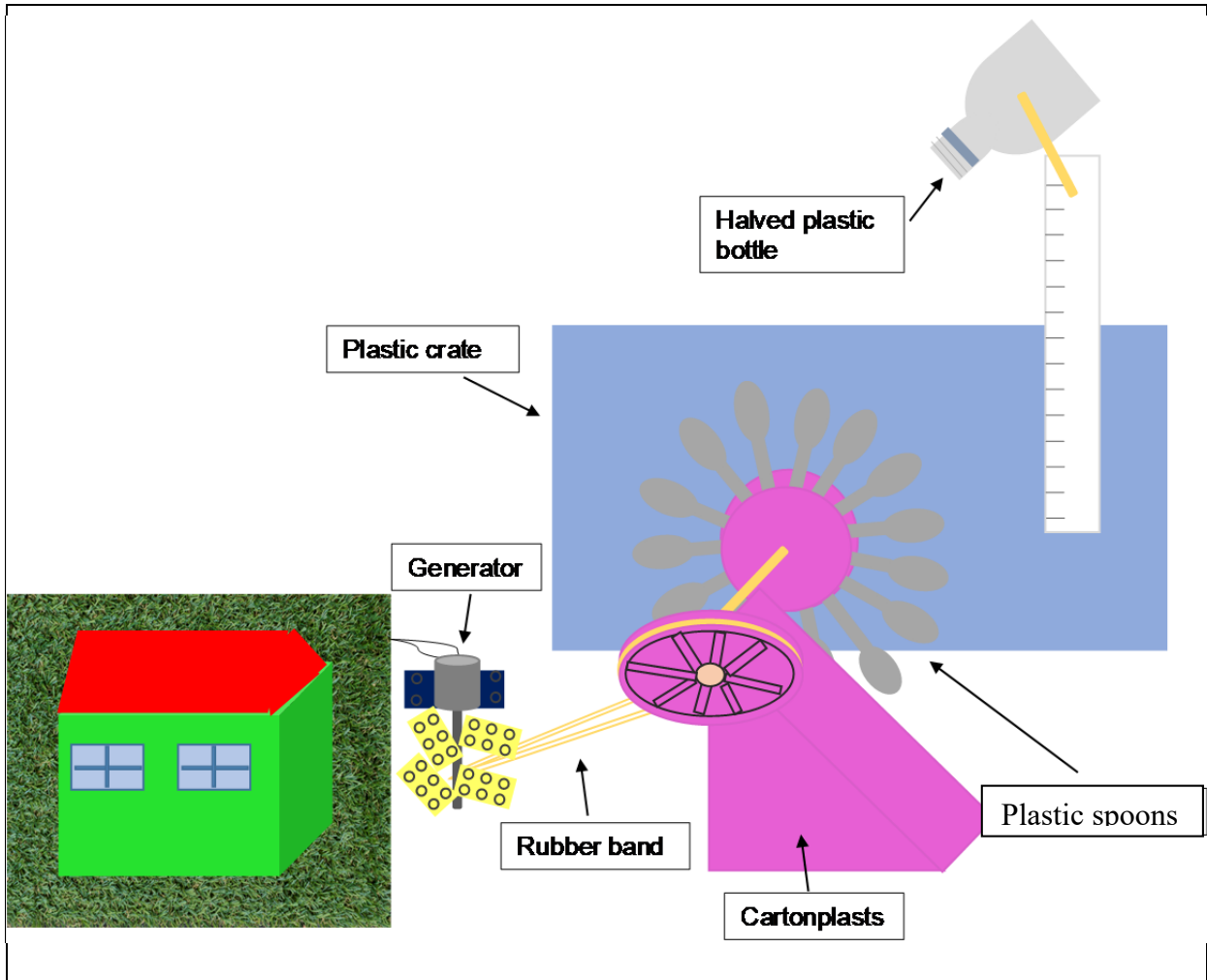



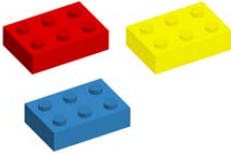



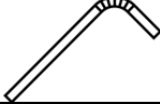

Figure 5. : H 3. Drawing.

#### 1.2.1.3.2. List of materials and components

Table 3. : H 3. List of materials

<ul style="list-style-type: none"> <li>• Ruler</li> </ul> <p>Sizes: Length: 30 cm Width: 3 cm</p>	
<ul style="list-style-type: none"> <li>• 1 litre plastic bottle (halved)</li> </ul>	

<ul style="list-style-type: none"> <li>Bamboo skewers (broken)</li> </ul>	
<ul style="list-style-type: none"> <li>Plastic crate</li> </ul> <p>Sizes: Length: 30 cm Width: 10 cm</p>	
<ul style="list-style-type: none"> <li>Sixteen disposable plastic spoons</li> </ul>	
<ul style="list-style-type: none"> <li>Six cartonplasts</li> </ul> <p>Sizes: A4</p>	
<ul style="list-style-type: none"> <li>Cylindrical wooden rod</li> </ul> <p>Sizes: Length: 20 cm Diameter: 1 cm</p>	
<ul style="list-style-type: none"> <li>Semi-circular small piece of metal slab (platen) (curved)</li> </ul> <p>Sizes: Length: 2 cm Width: 1 cm</p>	
<ul style="list-style-type: none"> <li>Superglue</li> </ul>	
<ul style="list-style-type: none"> <li>Generator (motor)</li> </ul>	
<ul style="list-style-type: none"> <li>Led diode</li> </ul>	
<ul style="list-style-type: none"> <li>Two jar rubbers (rubber band)</li> </ul>	
<ul style="list-style-type: none"> <li>Two styrofoams (circle)</li> </ul> <p>Sizes: Diameter: 10 cm</p>	
<ul style="list-style-type: none"> <li>Four Legos (Rectangle form)</li> </ul> <p>Sizes: Length: 2 cm Width: 1 cm</p>	
<ul style="list-style-type: none"> <li>Lego rod</li> </ul> <p>Sizes: Length: 5 cm</p>	
<ul style="list-style-type: none"> <li>Crocodile clip</li> </ul> <p>Sizes: Length: 15 cm</p>	

<ul style="list-style-type: none"> <li>• Lego piece (which holds the generator) (Bigger than the previous four pieces of Lego) (Rectangle form) Sizes: Length: 4 cm Width : 2cm</li> </ul>	
<ul style="list-style-type: none"> <li>• Small plastic house</li> </ul>	
<ul style="list-style-type: none"> <li>• Two straws (painted black and brown)</li> </ul>	
<ul style="list-style-type: none"> <li>• Table tennis ball (painted green)</li> </ul>	
<ul style="list-style-type: none"> <li>• The basis is styrofoam (painted green) Sizes: Length: 55 cm Width: 25 cm</li> </ul>	
<ul style="list-style-type: none"> <li>• Tempera paint (different colour)</li> </ul>	

### 1.2.1.3.3. Description of the process

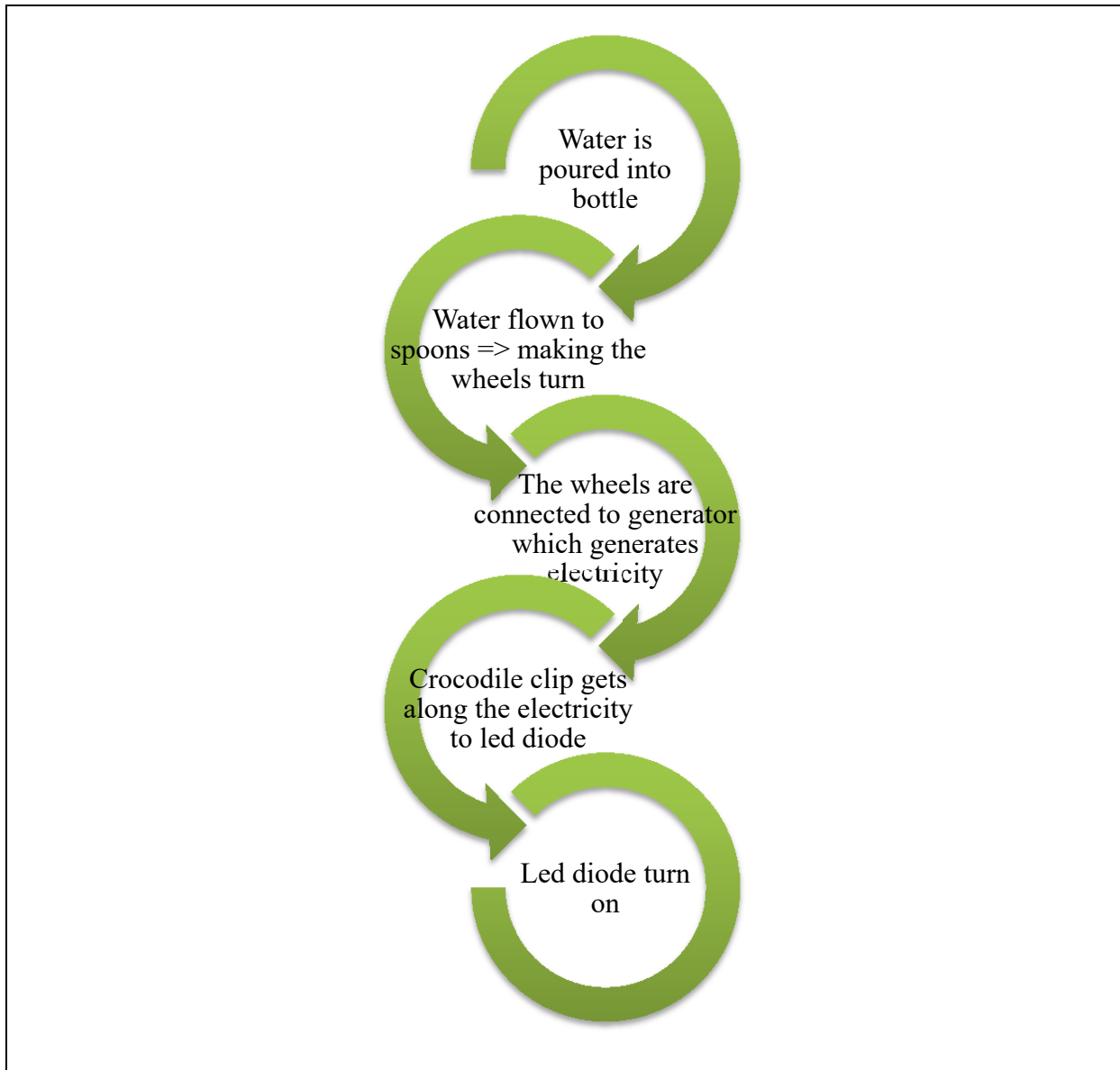

Figure 6.: The description of the process in a few words

### 1.2.1.3.4. Steps to build the model

- Firstly, place the plastic crate in the basis and fix the ruler in one side of the plastic crate using superglue.
- Have a one litre plastic bottle halved and punch two holes (the diameter of which is 1 cm) in the middle of it thrust the halved bamboo skewers (which are 5 cm long) into the bottle. Furthermore, thrust it into ruler. Fix half plastic bottle into ruler. The half plastic bottle incline 45° so the water will flow 45°.
- Cut four circle forms (which are same sizes) from A4 size cartonplast.

The diameter is 14 cm.

- Carve (or cut) sixteen plastic spoons to sharp form with a knife or a similar appropriate gadget, a pencil sharpener drawing tool can even be used.
- Thrust this plastic spoons into the styrofoam (the form is circular). The styrofoam diameter is 10 cm, therefore thrust the plastic spoons into the styrofoam with a distance of 1,96 cm between them.
- Then if these plastic spoons are fixed in the styrofoam, stick the whole styrofoam circle and the two circle formed cartonplasts together (with superglue).
- Stick another styrofoam circle between the two cartonplasts.
- Drill two holes in the middle of the two circles. The diameter is 1 cm.
- Put the two circles on the cylindrical wooden rod. Place two circles at the two edges of the cylindrical wooden rod. Later fix these two circles with superglue.
- Draw wheel spokes in the outer edge of the two circles. It will be more lifelike.
- Build quadrilaterals from the rest of the cartonplast.
- Firstly, make two right triangles. Their sizes are the same.

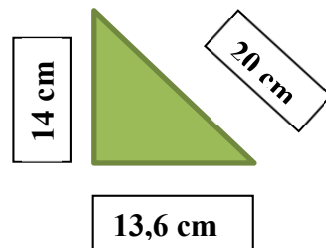

- Cut (right side) rectangle.

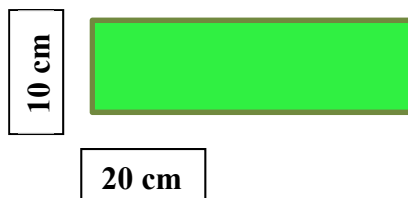

- Create (left side) rectangle.

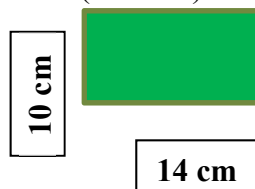

- Stick these previous four pieces together with superglue. Then stick this quadrilateral (which is made from cartonplasts) on the basis (styrofoam).
- Put the prepared propellers on this quadrilateral. The small semi-circular piece of metal slab (curved) helps with fixing. Stick this metal slab (with the propeller in it) and the quadrilateral together.

- Put the Lego cubes (four pieces) on the Lego rod and place the two jar rubbers to this Lego rod and one of circles.
- Suit the generator on the end of the Lego rod and we fix it with superglue.
- Put the bigger Lego piece (the sizes of which are: 4 cm length and 2cm width) under the generator. This Lego piece holds generator.
- Stick the Lego rod to the basis (styrofoam) as well as this bigger Lego piece.
- Then connect the crocodile clip to the generator. Another end of the crocodile clip is connected to led diode.
- Make the lamp following these steps: halved straw (length: 5 cm) and lead the crocodile clip (with the led diode) into the straw. Stick this straw on the basis and paint the straw black colour (with tempera paint).
- The small plastic house which is stuck on the basis next to the Lego structure was bought.
- Half another straw, and make the tree from the straw. Firstly, paint the tree brown colour, and paint the table tennis ball green. Stick the green table tennis ball and the brown straw together. Put this element next to the small plastic house.
- Paint the cartonplast pink colour.

#### **1.2.1.3.5. Pedagogical explanation**

Pour water from a big plastic bottle (for example: from a 2 litre plastic bottle) to the halved small plastic bottle, and the water will flow to the plastic spoons which will start to turn (initially slowly). Two circles start to turn. As one of the circles is connected to the Lego rod (which is the generator), and the crocodile clip is also connected to the motor which leads the energy to the led diode, the led diode will light while the water is flowing. This is the way of generating electricity from water. [7]

### 1.2.2. Electric power generation from eolic sources

In this section, the analysis of three models in which eolic energy is transformed into electricity is included.

#### 1.2.2.1. Electric power generation from eolic sources option 1.

##### 1.2.2.1.1. Initial design of the model

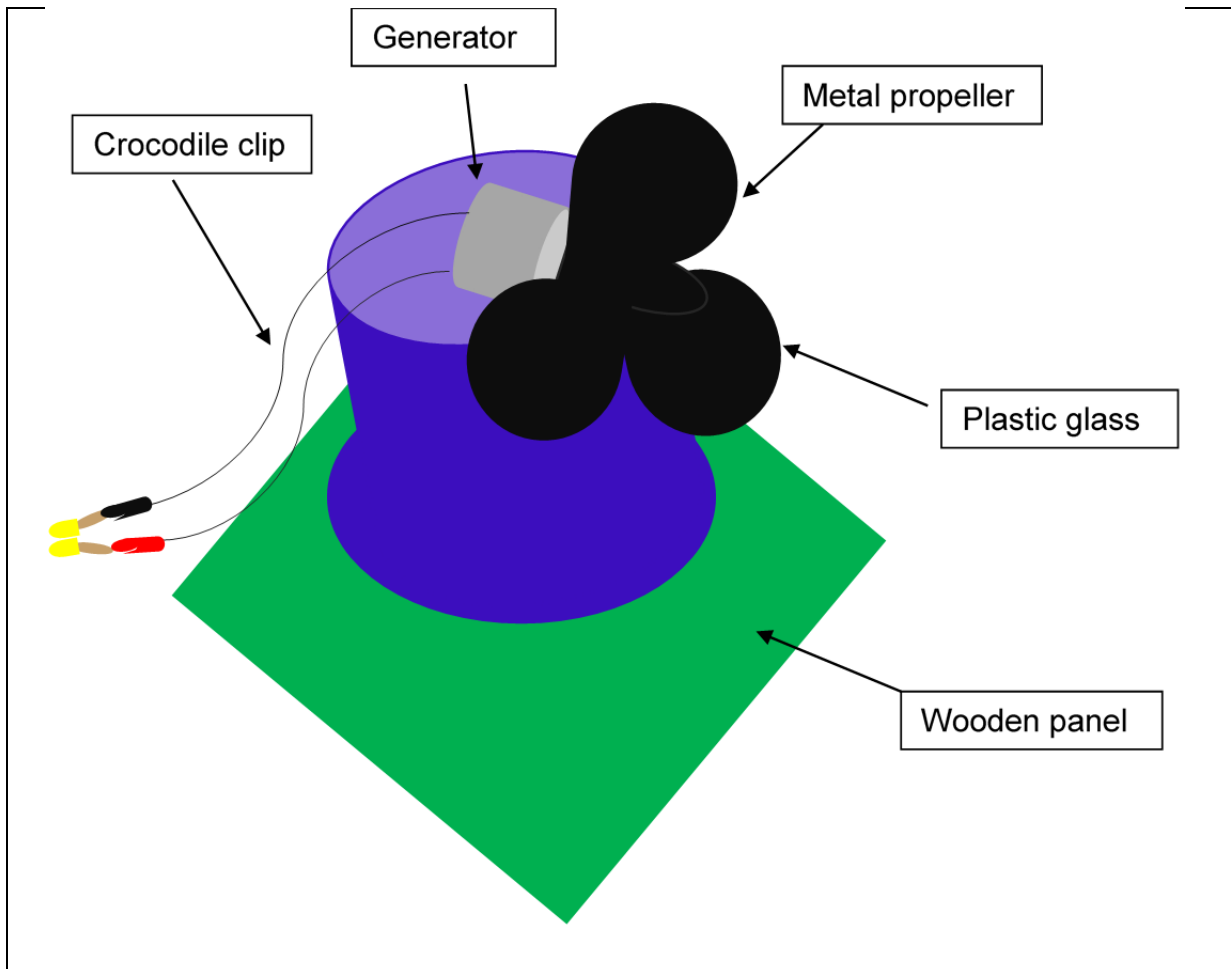







Figure 7. : E 1. Drawing



### 1.2.2.1.2. List of materials and components

Table 4. : E 1. List of materials

<ul style="list-style-type: none"> <li>• Basis: wooden panel</li> </ul> <p>Cube shape Every side is: 10 cm</p>	
<ul style="list-style-type: none"> <li>• Generator (motor)</li> </ul> <p>Sizes: Diameter: 4 cm Length: 2 cm</p>	
<ul style="list-style-type: none"> <li>• Two led diodes</li> </ul> <p>Sizes: Length: 4 cm</p>	
<ul style="list-style-type: none"> <li>• Crocodile clip</li> </ul> <p>Sizes: Length: 15 cm</p>	
<ul style="list-style-type: none"> <li>• Metal propeller (from a mini size ventilator, this is the turbine)</li> </ul> <p>Sizes: Diameter: 10 cm</p>	
<ul style="list-style-type: none"> <li>• Disposable plastic glass</li> </ul> <p>Sizes: Tonnage: 2 dl Length: 98 mm Diameter up/down: 71/45 mm Material: PS Quantum: 2,4g</p>	
<ul style="list-style-type: none"> <li>• Glue gun</li> </ul>	
<ul style="list-style-type: none"> <li>• Tempera paint (green, blue colour)</li> </ul>	
<ul style="list-style-type: none"> <li>• Hair dryer</li> </ul>	
<ul style="list-style-type: none"> <li>• Soldering</li> </ul>	

### 1.2.2.1.3. Description of the process

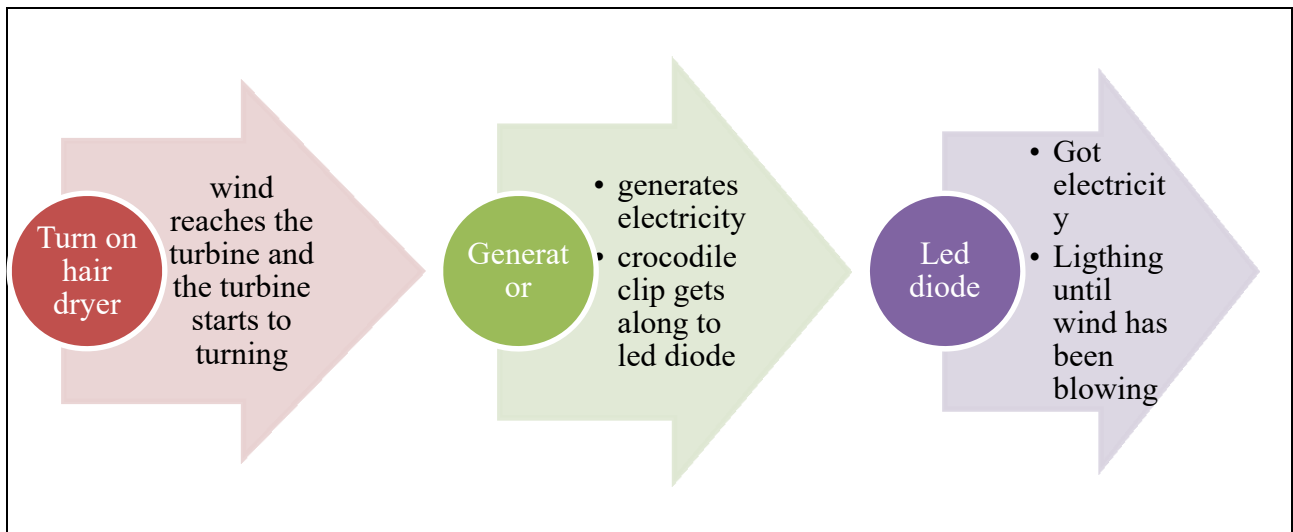

**Figure 8.: The description of the process in a few words**

### 1.2.2.1.4. Steps to build the model

- Firstly, stick the side of the disposable plastic glass into the wooden panel (which will be the basis) with the glue gun.
- Secondly, stick the generator to the top of the plastic glass (with glue gun).
- Put the metal propeller (namely, this is the turbine) to the generator and twist together.
- The rotor part of the wind energy model is finished.
- Solder end of crocodile clip (smaller end) into generator (motor).
- Take two led diodes and fix them to the crocodile clip by soldering.
- Paint the wooden panel green and paint the disposable plastic glass blue colour.
- When all previous steps are finished, finally, the hair dryer will be used in front of this structure to activate the system.

### 1.2.2.1.5. Pedagogical explanation

When the wind reaches the wind turbine (namely propeller), it starts to turn. The generator (which is located in the rotor) also turns together with the turbine. While the generator is turning it creates electricity. When the generator generates electricity, the crocodile clip leads this created electricity to the led diode. Due to that, the led diode starts to light. While the wind turbine is turning the led diode is lighting. [8]

### 1.2.2.2. Electric power generation from eolic sources option 2.

#### 1.2.2.2.1. Initial design of the model

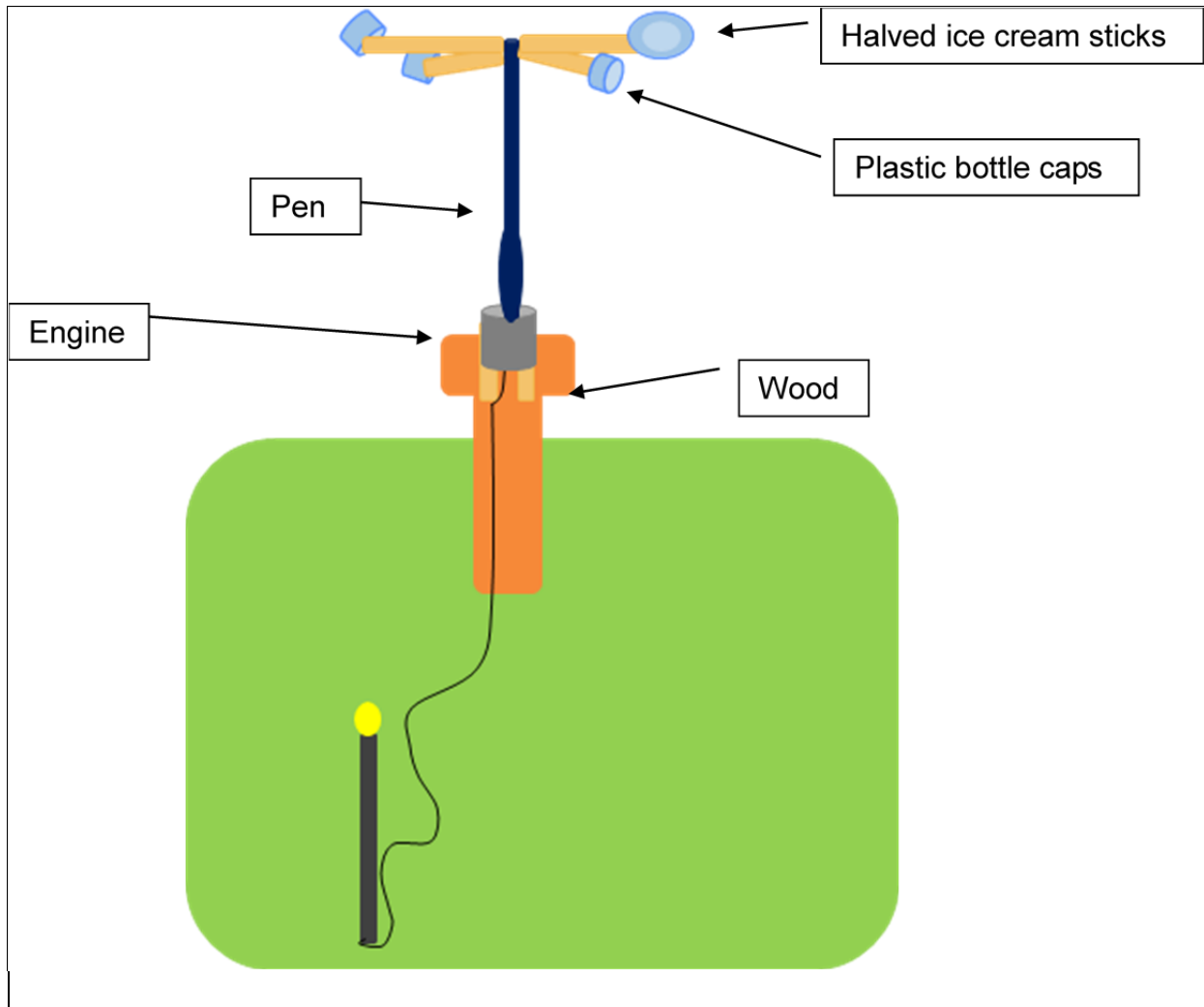





Figure 9. : E 2. Drawing.

#### 1.2.2.2.2. List of materials and components

Table 5. : E 2. List of materials

<ul style="list-style-type: none"> <li>• Four ice cream sticks</li> </ul>	
<ul style="list-style-type: none"> <li>• Four plastic bottle caps</li> </ul>	

<ul style="list-style-type: none"> <li>• Pen</li> </ul>	
<ul style="list-style-type: none"> <li>• Superglue</li> </ul>	
<ul style="list-style-type: none"> <li>• Wood panel</li> </ul> <p>Sizes: Length: 10 cm Width: 5 cm Thickness: 1 cm</p>	
<ul style="list-style-type: none"> <li>• Wood panel (bigger)</li> </ul> <p>Sizes: Length: 25 cm Width: 6 cm Thickness: 1 cm</p>	
<ul style="list-style-type: none"> <li>• Wood panel (the most biggest, which is the basis)</li> </ul> <p>Length: 25 cm Width: 12 cm Thickness: 1 cm</p>	
<ul style="list-style-type: none"> <li>• Generator</li> </ul>	
<ul style="list-style-type: none"> <li>• Crocodile clip</li> </ul>	
<ul style="list-style-type: none"> <li>• Straw</li> </ul>	
<ul style="list-style-type: none"> <li>• Hair dryer</li> </ul>	
<ul style="list-style-type: none"> <li>• Tempera paint</li> </ul>	
<ul style="list-style-type: none"> <li>• Secateurs</li> </ul>	
<ul style="list-style-type: none"> <li>• Led diode</li> </ul>	
<ul style="list-style-type: none"> <li>• The basis is green paper (A4)</li> </ul>	

### 1.2.2.2.3. Description of the process

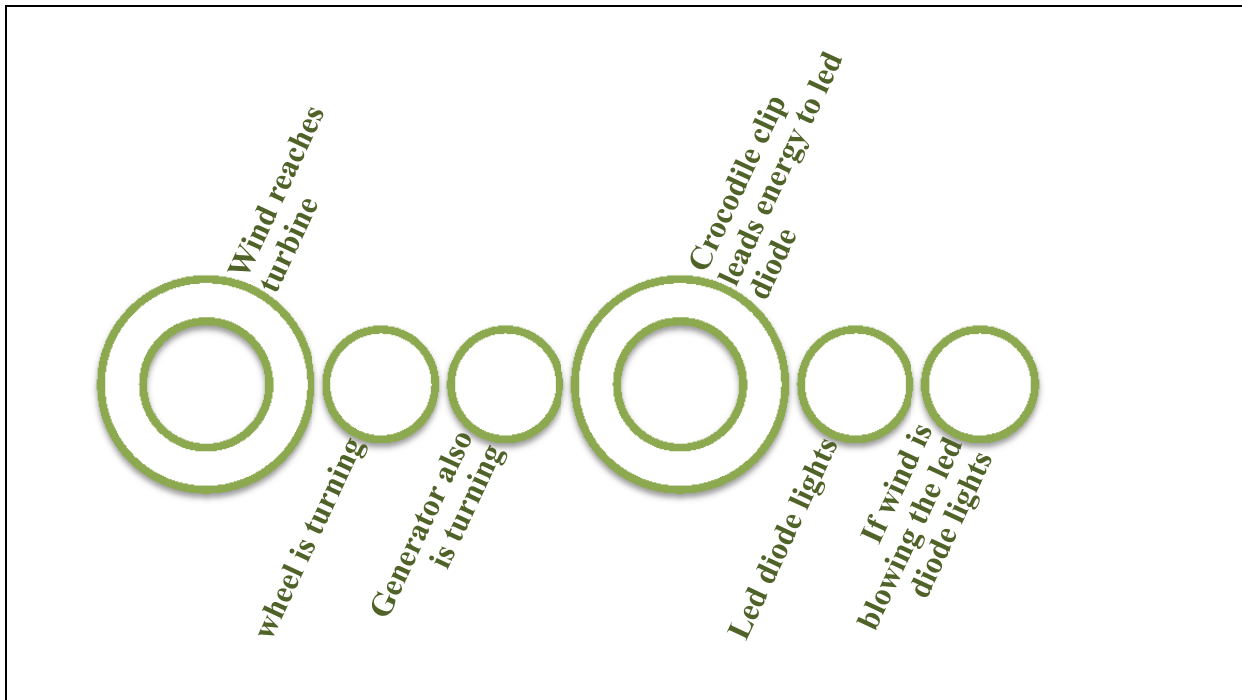

Figure 10.: The description of the process in a few words

### 1.2.2.2.4. Steps to build the model

- Two ice cream sticks have to be halved by secateurs.
- Stick each ice cream stick to a plastic bottle cap.
- The pen is taken apart.
- Suit the agglutinated ice cream stick to the pen with superglue. The turbine has been made.
- Stick the bigger wood panel to the biggest panel.
- Stick the small wood panel to the top of the bigger wood panel (use superglue)
- Stick two pieces of ice cream stick on the top of the small wood panel.
- The generator is stuck with two pieces of ice cream sticks together, to the small wood panel.
- The crocodile clip is connected to the generator.
- Drill a small hole to one side of the straw (where the crocodile clip is lead).
- Stick the crocodile clip to the wooden panel and stick the straw there.
- Connect the led diode to the crocodile clip. Paint the straw black as lamps (streetlight).
- Suit the propeller into the generator.
- Use a hair dryer.

### 1.2.2.2.5. Pedagogical explanation

When the hair dryer is turned on, wind is created. When wind reaches the wind turbine (propeller), the wheel starts to turn. The wind turbine will be turned by the wind. The generator is connected to the crocodile clip, which leads created current to the led diode. When the current reaches the led diode, it starts to light. The motor generates electricity. [9]

### 1.2.2.3. Electric power generation from eolic sources option 3.

#### 1.2.2.3.1. Initial design of the model

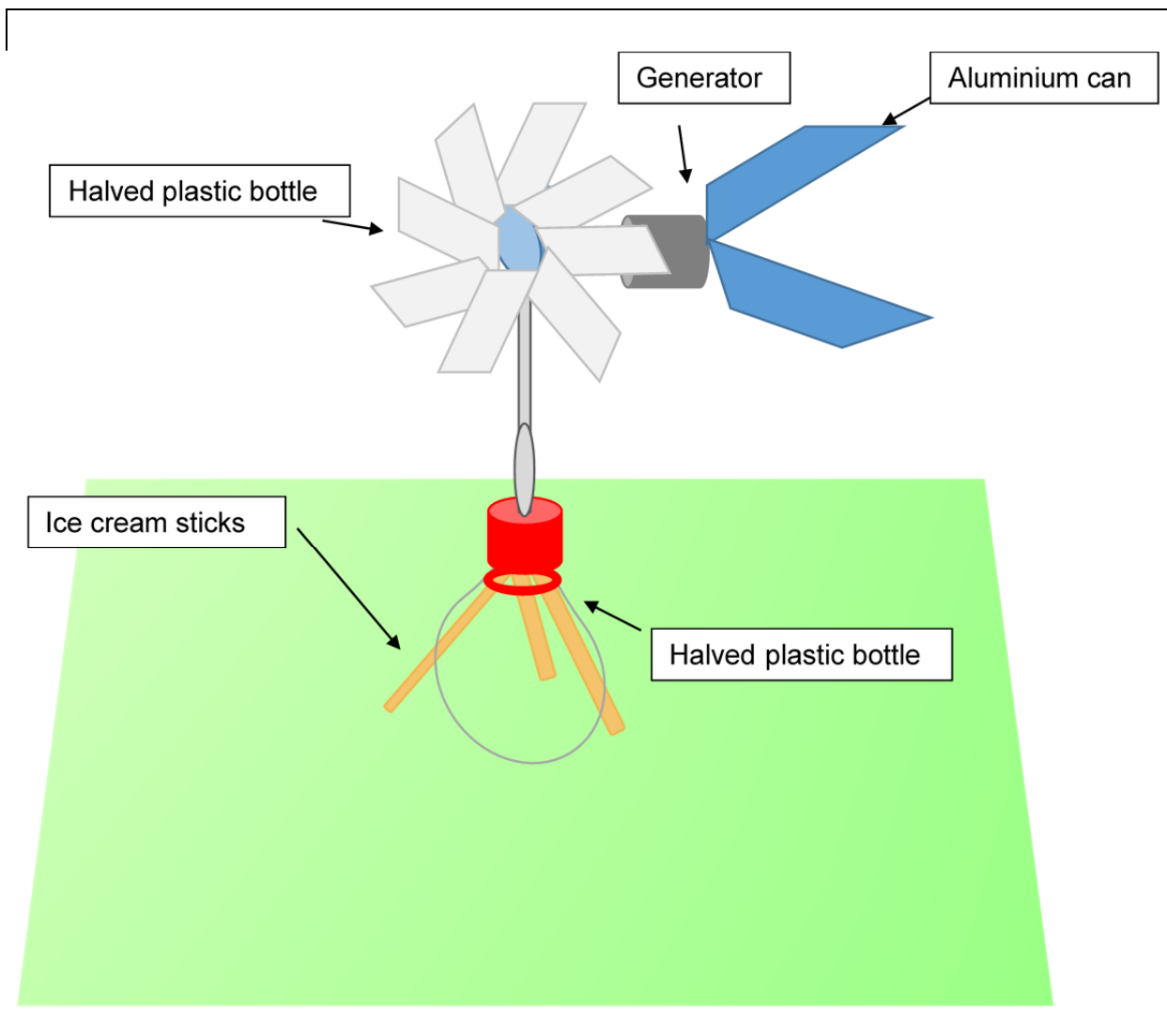





Figure 11. : E 3. Drawing.

### 1.2.2.3.2. List of materials and components

**Table 6. : E 3. List of materials**

<ul style="list-style-type: none"> <li>Two half litre plastic bottles</li> </ul>	
<ul style="list-style-type: none"> <li>Two plastic bottle caps</li> </ul>	
<ul style="list-style-type: none"> <li>Metal wire</li> </ul> <p>Sizes: Length: 15 cm Diameter: 1 cm</p>	
<ul style="list-style-type: none"> <li>Superglue</li> </ul>	
<ul style="list-style-type: none"> <li>Sharp knife</li> </ul>	
<ul style="list-style-type: none"> <li>Scissors</li> </ul>	
<ul style="list-style-type: none"> <li>Hair dryer</li> </ul>	
<ul style="list-style-type: none"> <li>Drill</li> </ul>	
<ul style="list-style-type: none"> <li>Pen (pen refill, grip of pen)</li> </ul>	
<ul style="list-style-type: none"> <li>Aluminium can</li> </ul>	
<ul style="list-style-type: none"> <li>Generator</li> </ul>	
<ul style="list-style-type: none"> <li>Crocodile clip</li> </ul>	
<ul style="list-style-type: none"> <li>Wood panel</li> </ul> <p>Sizes: Length: 25 cm Width: 20 cm Thickness: 3 cm</p>	
<ul style="list-style-type: none"> <li>Led diode</li> </ul>	
<ul style="list-style-type: none"> <li>Two ice cream sticks</li> </ul>	

### 1.2.2.3.3. Description of the process

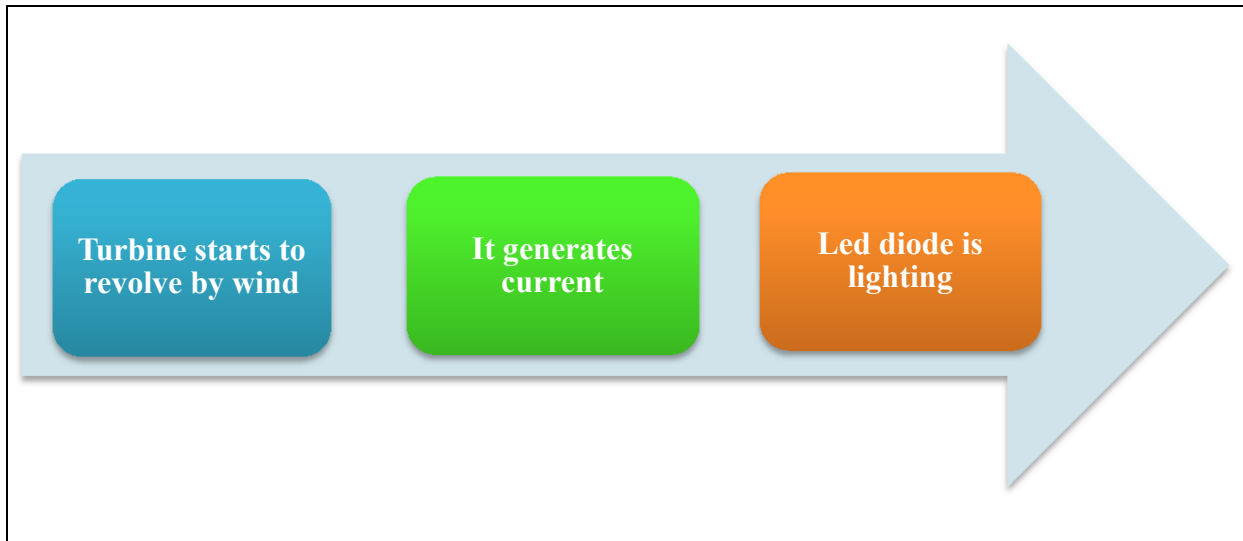

**Figure 12.: The description of the process in a few words**

### 1.2.2.3.4. Steps to build the model

- Cut the half litre plastic bottle in smaller pieces (with the sharp knife).
- Cut the small half litre plastic bottle in eight pieces. It will be a mini propeller (with appropriate scissors).
- Drill a hole in the middle of the plastic bottle cap with the drill (diameter is 0,5 cm).
- Fix the metal wire in the middle of the plastic bottle cap with superglue.
- The pen is taken apart.
- The pen refill is halved by scissors.
- Drill a hole in the grip of the pen.
- The pen refill is transfixed in the grip of the pen.
- The previous structure is suited in the pen.
- The metal wire (with the plastic bottle propeller) is inserted through the grip of the pen (where the hole was drilled).
- Crook the metal wire. The goal is to fix this structure together. When it is fixed, cut the unnecessary parts.
- Cut both ends of the aluminium can with the knife.
- The aluminium can is crooked to the flat form.
- Drill a hole in the middle of the aluminium can.
- Cut small parts from the aluminium can.
- Fix the generator in the turbine (using superglue).
- Fix the aluminium can in the generator wire with superglue.
- Fix the crocodile clip to the generator and connect it to the led diode with superglue.
- Another half litre plastic bottle is halved.





- Two ice cream sticks are halved. Stick three halved ice cream sticks with the halved plastic bottle.
- A hole is drilled in the middle of the plastic bottle cap (diameter is 2 cm).
- The pen is suited in the middle of the plastic bottle cap (with superglue) and screw it the in plastic glass.
- This structure is fixed in the wooden panel with superglue.

#### 1.2.2.3.5. Pedagogical explanation

Wind causes the turbine to turn, while the hair dryer is working. When this propeller is turning, the generator helps to generate electricity. As there is a crocodile clip connected to this motor, therefore, the crocodile clip leads the created energy (current) to the led diode, and due to that, the led diode lights.[10]

### 1.2.3. Electric power generation from photovoltaic sources

This part of the case study deals with three options of photovoltaic energy transformed into electric energy.

#### 1.2.3.1. Electric power generation from photovoltaic sources option 1.

##### 1.2.3.1.1. Initial design of the model

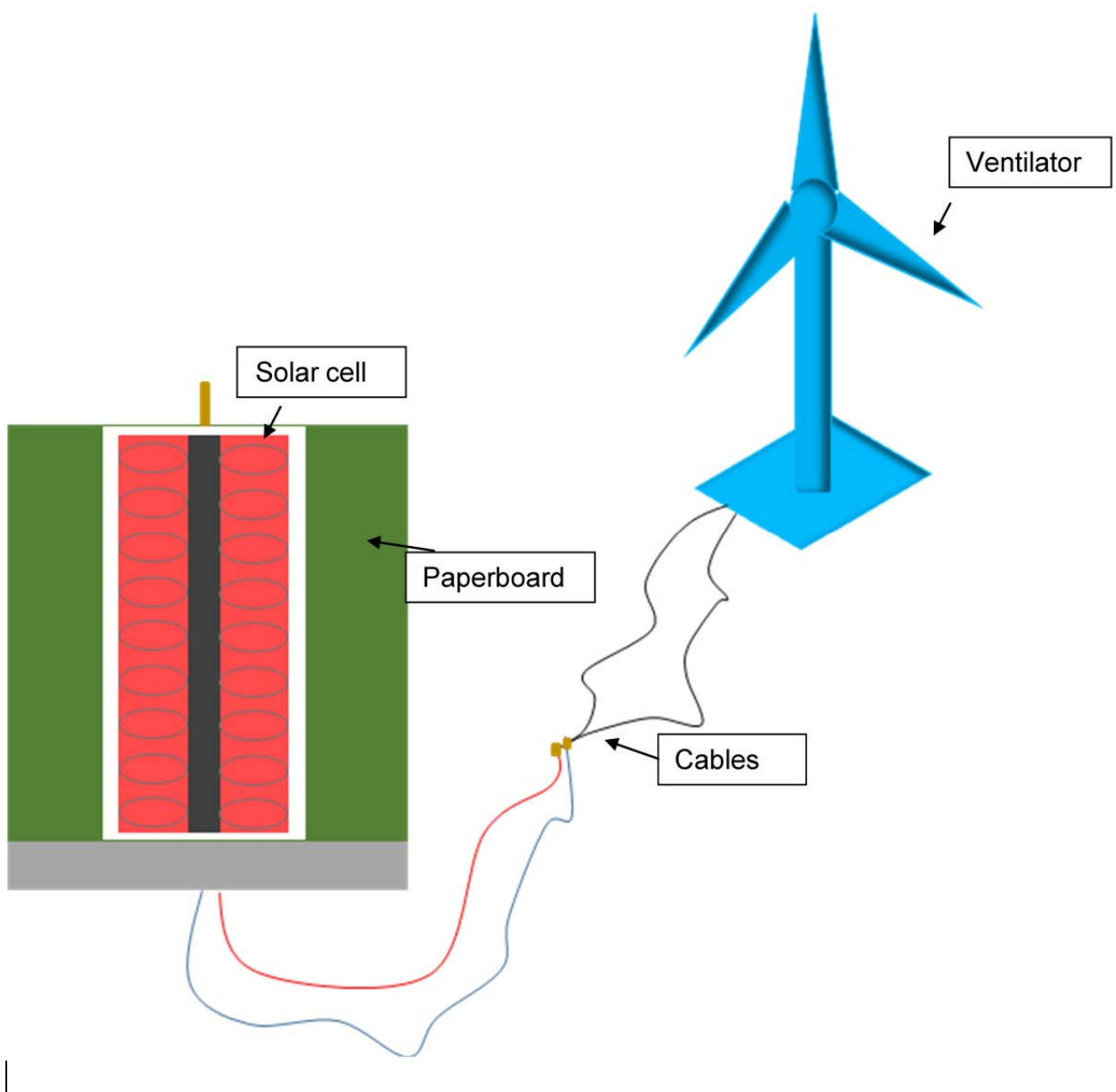









Figure 13. : P 1. Drawing.

### 1.2.3.1.2. List of materials and components

Table 7. : P 1. List of materials

<ul style="list-style-type: none"> <li>Flat paper pizza box (paperboard, lid of a box)</li> </ul> <p>Sizes: 16x16cm</p>	
<ul style="list-style-type: none"> <li>Aluminium foil</li> </ul>	
<ul style="list-style-type: none"> <li>Thin aluminium wire</li> </ul>	
<ul style="list-style-type: none"> <li>Two electrical cables</li> </ul>	
<ul style="list-style-type: none"> <li>Small duct tape (scotch tape isolated, insulating tape)</li> </ul>	
<ul style="list-style-type: none"> <li>Superglue</li> </ul>	
<ul style="list-style-type: none"> <li>Scissors</li> </ul>	
<ul style="list-style-type: none"> <li>Small solar panel (bought from eBay)</li> </ul> <p>Sizes: Length: 17 cm Width: 6 cm</p>	
<ul style="list-style-type: none"> <li>Ventilator</li> </ul> <p>Size: Height: 22 cm</p>	
<ul style="list-style-type: none"> <li>Battery</li> </ul>	
<ul style="list-style-type: none"> <li>Four toothpicks</li> </ul>	
<ul style="list-style-type: none"> <li>Toothpaste</li> </ul>	
<ul style="list-style-type: none"> <li>Copper sulphate</li> </ul>	
<ul style="list-style-type: none"> <li>Saline solution (water with salt)</li> </ul>	

<ul style="list-style-type: none"> <li>Lemon juice</li> </ul>	
<ul style="list-style-type: none"> <li>Steel shavings</li> </ul>	
<ul style="list-style-type: none"> <li>Synthetic enamel (coloring spray)</li> </ul>	
<ul style="list-style-type: none"> <li>Small brush</li> </ul>	

### 1.2.3.1.3. Description of the process



Figure 14.: The description of the process in a few words

### 1.2.3.1.4. Steps to build the model

- Firstly, cut the appropriate size (17x17cm) from the aluminium foil and create two pieces of little cubes form the part which is longer than the original size.
- Stick the aluminium foil to the paper pizza box (paperboard) with duct tape.
- The two toothpicks are located at the opposite side of the rectangle form paper board (which is just simple pizza box).

- One of the toothpicks is located in the middle of the side of the paper board and another piece of toothpicks is located at the other side of the paperboard, and the edge of this side.
- Cut the aluminium foil with scissors.
- Two toothpicks are suited under the two pieces of small aluminium foil.
- Then the toothpicks are fixed to the aluminium foil pieces using insulating tape.
  
- Use synthetic enamel (coloring spray) in the middle of the aluminium foil (in rectangle form). This is red colour.
- The solar panel is fixed in the paper board.
- The next step is the proper leading of the cables.
- Two cables are connected into the two ends of the cable of the solar panel.
- The two cables are fixed with insulating tape.
- Toothpaste is mixed with saline solution in one glass.
- The solar panel is painted with the earlier created solution using a small brush.
- The aluminium foil is painted green colour using a small brush.
- The previous wet surface is sprinkled thoroughly with some steel shavings.
- The ventilator put on the table.
- The full charged battery is suited to the two ends of the cables of the ventilator.
- When it is put to the ventilator cables, the ventilator turns because of the current.
- The battery is put aside next to this ventilator.
- The ventilator cables are connected to the two cables of the solar panel.

#### **1.2.3.1.5. Pedagogical explanation**

Use this photovoltaic model (solar panel cells) if the Sun has been shining but just exclusively in this case. The solar cell is like sandwich. It has a negative and a positive part. The negative side is blue and the positive side is red. When sunshine reaches the top of the small solar panel, the solar panel produces energy from the Sun rays. This energy is led by the cables (which are connected to this small solar panel). The other end of the cables are connected to the small ventilator. These cables get along the energy to the ventilator. So energy is created. The turbine of the ventilator works (it is turning) while the sun shines, so the ventilator got current. [11]

### 1.2.3.2. Electric power generation from photovoltaic sources option 2.

#### 1.2.3.2.1. Initial design of the model

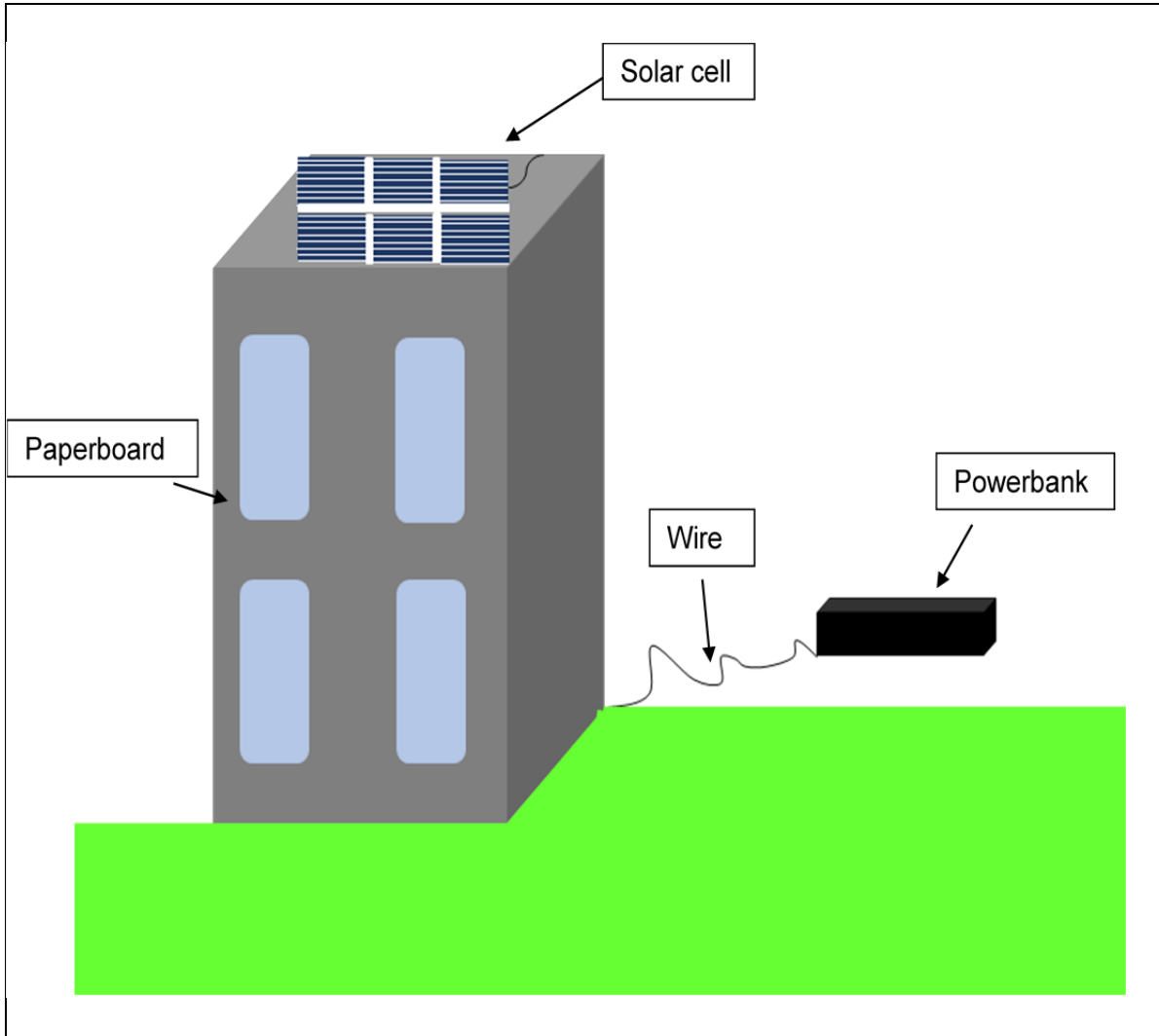





Figure 15. : P 2. Drawing.

### 1.2.3.2.2. List of materials and components

**Table 8.: P 2. List of materials**

<ul style="list-style-type: none"> <li>• Multi-meter</li> </ul>	
<ul style="list-style-type: none"> <li>• Transparent nail polish</li> </ul>	
<ul style="list-style-type: none"> <li>• Old phone charger</li> </ul>	
<ul style="list-style-type: none"> <li>• Wire</li> </ul> <p>Sizes: Length: around 1 meter</p>	
<ul style="list-style-type: none"> <li>• Two component glue</li> </ul>	
<ul style="list-style-type: none"> <li>• Ten small solar cells (bought from eBay)</li> </ul>	
<ul style="list-style-type: none"> <li>• Two plastic pieces</li> </ul>	
<ul style="list-style-type: none"> <li>• Soldering</li> </ul>	
<ul style="list-style-type: none"> <li>• Paper box</li> </ul> <p>Sizes: Width: 10 cm Length: 20 cm</p>	
<ul style="list-style-type: none"> <li>• Superglue</li> </ul>	
<ul style="list-style-type: none"> <li>• Colourful papers</li> </ul>	
<ul style="list-style-type: none"> <li>• Tempera</li> </ul>	
<ul style="list-style-type: none"> <li>• Power bank</li> </ul>	

### 1.2.3.2.3. Description of the process

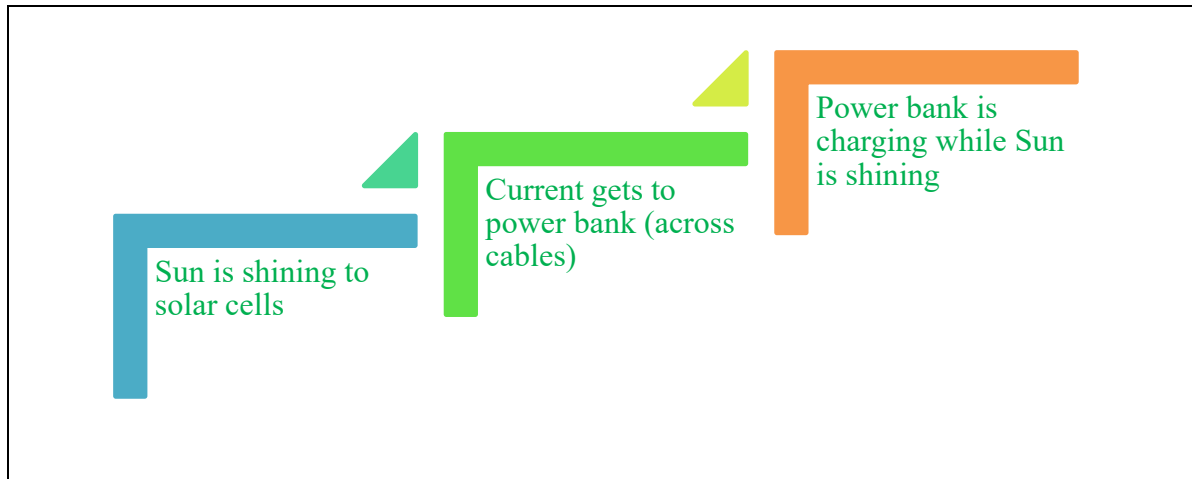

Figure 16.: The description of the process in a few words

### 1.2.3.2.4. Steps to build the model

- Firstly, the solar cells are covered by transparent nail polish.
- This is really the cheapest method.
- This material helps to protect small solar cells from the corrosion of the batteries due to the Sun.
- Solder the negative and the positive wires at the two ends of the solar cells using soldering.
- The two component glue is mixed, and a small amount of glue is placed on each solar cell. As these solar cells are very fragile, do this step carefully.
- Put the solar cells between the two plastic pieces.
- Press very gently to connect the glue with the two pieces of plastic.
- The cable (from the old phone charger) is put on the solar panel.
- This cable is connected to the power bank, so the power bank is charged directly.
- The last step is to fix the structure to the top of the paper box using superglue.
- The paper box is a small size storey house.
- The paper box is painted grey colour.
- Cut little cubes from the colourful papers.
- These will be the windows on the storey house which will be blue colour.
- The grass can be built by using green paper.



### 1.2.3.2.5. Pedagogical explanation

As solar cells are similar to a simple sandwich, therefore the solar cells have two types. It has negative type silicon (the colour of which is blue) and also has positive type silicon (whose part is red).

When sunlight reaches the top of the solar cells. Firstly, photons carry the created energy, then photons give this energy to the electrons. The electrons use this energy to get to the negative-type layer, furthermore, electrons escape out into the circuit. Flowing around the circuit, the electrons charge the power bank. [12]

### 1.2.3.3. Electric power generation from photovoltaic sources option 3.

#### 1.2.3.3.1. Initial design of the model

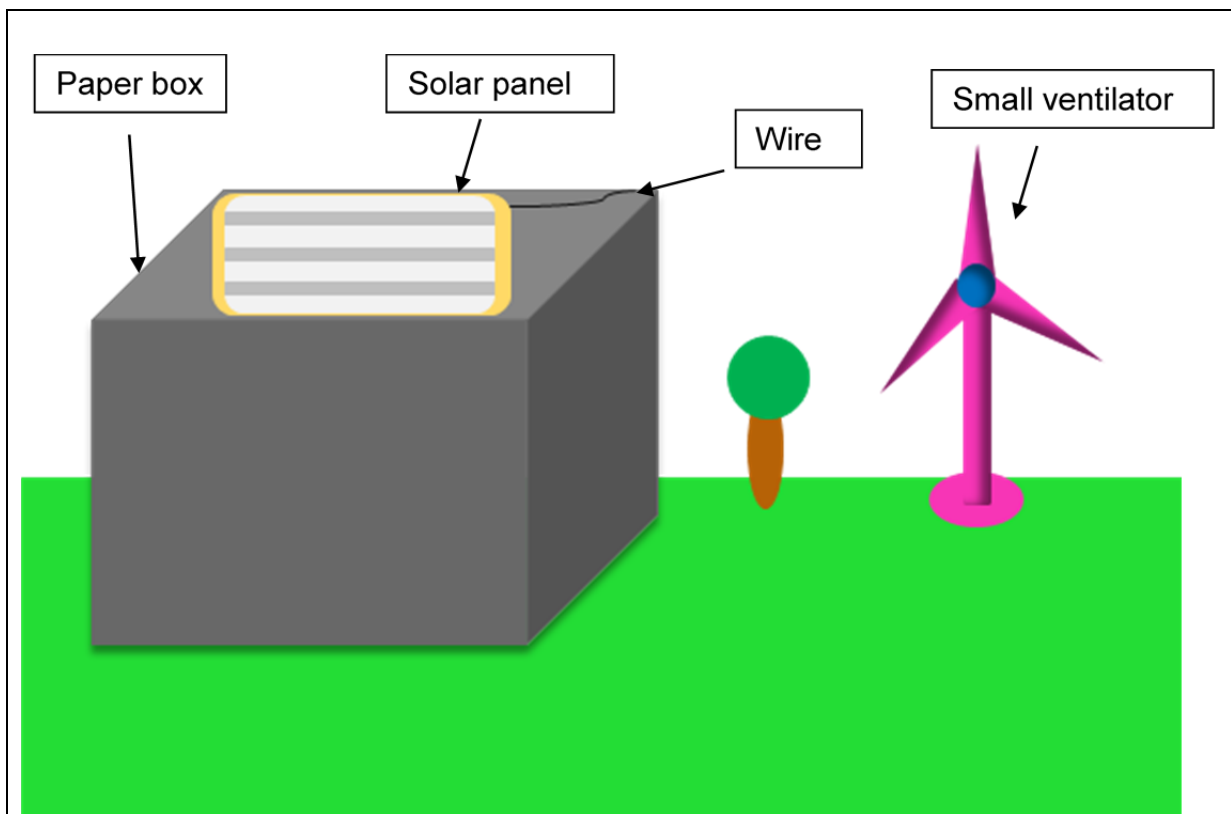

Figure 17. : P 3. Drawing.

### 1.2.3.3.2. List of materials and components

Table 9. : P 3. List of materials

• Tabbing wire
• Set of gloves
• Solar cell
• Masking tape
• Dab of solder
• Flux
• Two cables
• Small size ventilator Size: Height: 10 cm
• Colourful papers
• Soldering
• Ice cream stick
• Ping pong ball
• Tempera
• Superglue
• Paperboard Sizes: Length: 15 cm Width: 15 cm

### 1.2.3.3.3. Description of the process

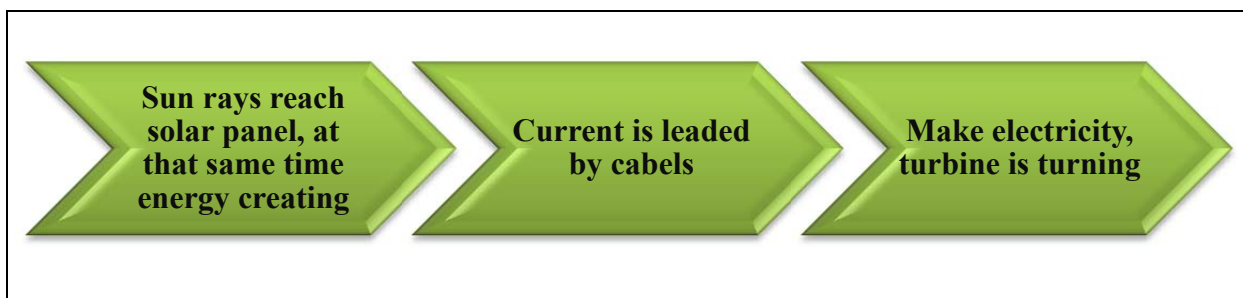

Figure 18.: The description of the process in a few words

#### 1.2.3.3.4. Steps to build the model

- In order to pre tab each of the twelve cells, you need to cut eighteen ten inch pieces of tabbing wire and six five and a quarter inch pieces.
- Then enroll the tabbing wire from the spool.
- Have a pair of gloves before soldering these pieces of tabbing wire to the cell straighten each piece out with your thumb.
- It will make the job easier when you start to solder.
- Use set of gloves to prevent unwanted fingerprints on the solar panel.
- Solar cells are extremely fragile, therefore, making solar cells is a very careful and slow process.
- The best way to remove them from their stack is to pick them up from their paper.
- Place them near the edge of the table.
- The solar cell is placed on the workbench.
- The workbench is one of the square pieces of wood that protects the cells during shipment (carrying).
- The cell is fixed on the workbench.
- It will not slide around during the pre tabbing process.
- The masking tape is used very carefully so that it would be removable easily, about ten millimeters from the edge of the solar cell.
- It is placed perpendicular to the two traces. Solder the tabbing wire.
- Pre tabbing has been finished.
- Apply a couple of coats of flux to the traces on the cell.
- Take one of the ten inch pieces of tabbing wire and it is placed about an eighth of an inch from the edge of the cell.
- Apply a little dab of solder and hold it in place.
- Flux is used on the top of the tabbing wire before soldering it.
- Place about three eighths of an inch of solder on soldering iron.
- Spread the solder right on the top of the tabbing wire carefully and gently.
- The solder spread about halfway down the cell.
- Apply another three eighths of an inch of solder and spread it down the other half.
- Make sure there are no bumps or excess build up of solder.
- Repeat this process for the bottom trace: place a dab of solder to hold the tabbing wire in place, and more flux to the top of the wire.
- Carefully spread 3/8" of solder along the top of the tabbing wire, then, stop halfway and repeat.
- Then smooth out any excess build up of solder.
- Two pieces of cable is connected to this solar panel using soldering.
- The cables also are connected to the ventilator.
- Making the environment: Tree is created: the ice cream stick was stuck with the ping pong ball.



- The ping pong ball is painted the green and the ice cream stick is painted brown using tempera.
- The paper board is like a flat.
- The paper board is painted grey using tempera.
- Paint the ventilator pink colour.
- The A4 size green colour paper is suited in place.

#### 1.2.3.3.5. Pedagogical explanation

Sunlight reaches the solar cells. Inside a solar cell, there are two wafer-thin layers of silicon crystal like a sandwich. When sunlight hits the top silicon layer, it ‘excites’ the electrons and gives them enough energy to move. The electrons begin to flow from the top layer to the bottom. The cables which are connected to the solar cells and the cables of the ventilator help to lead energy to the ventilator. Photovoltaic solar cell generates DC (direct current).[13]

### 1.3. Description of three new models

#### 1.3.1. Description of the hydraulic model

In this section some explanations will be introduced. It might save money if instead of the sixteen disposable plastic spoons just twelve plastic spoons are applied. The appliance of sixteen plastic spoons is unnecessary because twelve plastic spoons is enough to work the hydraulic model. The ruler, the cartonplasts and the plastic crate is not necessary therefore these materials are negligible as it can be seen at the third hydraulic model's case. Instead of bicycle spoke we can use wooden rod. It is better to avoid the use of cartonplast or a very big size wood.

I would choose a plastic piece instead of green colour paper, because it is a harder material than simple paper.

This solution is of very low price. The materials are easily available. Only the wooden rod and the two plastic rods may cause a little problem but this price is very low. So it is possible to obtain easily.

We do not have to think about how we can obtain the appropriate materials, because we can collect them from children who do not have to pay for these materials.

#### 1.3.2. Description of the eolic model

The metal propeller is very high-priced therefore we need to avoid this device. The metal propeller is not such a material which would be easy to access. Instead of this device, it is better idea to use a CD as a propeller. Of course it is needed to cut the CD into three pieces. This is a very cheap way to build a propeller. However, the second and third eolic model propeller is very inexpensive too.

Everybody has scissors, therefore if kids can bring them to the workplace, it is the best way. So this way it is not necessary to buy scissors.

It is needles to buy disposable plastic glass because if somebody does not need this he/she can bring it to the workplace.

#### 1.3.3. Description of the photovoltaic model

In this case this model also has a reasonable price. We can buy the small solar panel from eBay. The price only 1 euro. So this is very cheap.

It is better to apply a small size paperbox instead of a big size one (for example in case of the second photovoltaic model). If tempera is used to paint the paperboard grey, it looks pretty good to children.

#### 1.4. Impact of the project on the rural development

The future generations would get awareness of renewable energy technologies.

The renewable energy education and training of renewable energy technologies is useful because it will give enough knowledge to kids. Teach kids to protect the environment, and they will use these energies instead of fossil fuels (for example: natural gas and oil etc.)

In these few paragraphs the antecedents of the impacts of the use of renewable energy technologies on rural development are introduced. The potential of renewable energy technologies to power rural development has been understood for many decades. Nevertheless, it is lately that huge efforts have been made to mobilize the resources to accomplish this potential and there is still a long way to proceed.

In September 2000, it was the first time that there was a connection between clean sources of energy and rural energy access. This connection was expressly prepared in the form of the United Nations General Assembly. This general assembly has obligation to a global companionship to reach a series of goals and targets, known as the Millennium Development Goals (MDGs), by the year 2015.

Reducing rural poorness through rural development is very essential to achieving these goals, furthermore, confirming this is the need for expanding the availability of new and modern energy services.

Modern energy services have a lot of advantages, they have benefits such as mechanical power, natural gas, electricity, clean cooking fuels, which consent to human prosperity. One of the goal is ensuring environmental sustainability which really promotes renewable energy technologies. The Millennium Development Goals, expressly remarks the relevance of modern energy services for rural development.

Some affordable environmental interferences have advantages and benefits, for example the use of an improved stove with traditional fuels. This able to decrease acute respiratory infection by 25 per cent among young kids and babies.

As referred by Rietbergen J. and Hadjemian N. [2]:

“Movement up the energy ladder can occur within various aspects of rural life: agriculture, household cooking, household lighting, heating. It seems logical to assume that increased access to modern energy services (moving up the energy ladder) can catalyse rural development (measured in increased income). In fact, there is a co-dependent relationship: access to modern energy services can increase incomes (if used productively) and an increase in income can make modern energy services more affordable.”

The decentralized nature of some renewable energy technologies allows them to be corresponded with the specific needs of different rural areas.

The opportunity of the acceptance of renewable energy technologies is essential for the success of traditional national grid-based rural electrification programmes. It is very important to reach small rural areas, communities in developing countries.

If the people would apply the cleaner use of traditional fuels in rural areas, it would be better because these use of fuels has positive impact to health. As these fuels improve health, for example they reduce acute respiratory infection and conjunctivitis, generally caused by indoor pollution. As these fuels do not pollute, therefore they have a good impact in rural areas.

The required time to household activities can be reduce with access to electricity.

Improved education to children and health to people who live in rural areas, combined with more time to undertake non-energy related activities, are important goals in themselves.

It is cited from Rietbergen J. and Hadjemian N.'s book [2]:

“However, access to modern energy services also have the added value of helping local populations to engage in income-generating activities. Demand for services associated with RETs can help generate local economic activity based on these technologies, in addition to the means to power local industry.”[2]

#### **1.4.1. Environmental impact**

Children learn about renewable energy technologies and renewable energy sources, including their works and building of renewable energy desktop models. Fortunately, it has positive impacts to the environment, as they will obtain and have enough knowledge about types of the renewable energy. They will apply this knowledge in their job in the future.

As kids will be able to build these models in real, they will cause a lot of positive impact to the world. The use of the renewable energies is an opportunity for the future, therefore it has a lot of good impacts. These are clean energies therefore they do not pollute the environment as they do not emit toxic gases.

If the future generations apply more renewable energy technologies, it will have positive impact on our world. They create energy and so on.

It is invoked from Rietbergen J. and Hadjemian N.'s book [2]:

“Applications of renewable energy technologies for productive activities vary from mechanical wind-powered water pumping to motorized milling machines for grinding grain. Radio services can provide farmers and fishermen with weather forecasts and telecommunication services can provide growers with information on crop prices (World Bank, 2004b). As noted by Steger (2005: 213), these applications can lead to job creation and improved livelihoods, both of which can contribute to significant increases in productivity in rural areas.”

In fact, the network extension is not the most cost-effective means of expanding access to rural areas. It is the specific of rural areas that the population density is extremely low. Unfortunately, it has greater technical losses too, because these transmission networks frequently increase.

By contrast, off-grid systems served by renewable energy technologies can be the best opportunity.

#### **1.4.2. Social and rural impact**

Kids and women mostly will have more time for education, leisure and economic activity which is also positive impact.

Fortunately, it has other wider health benefits which can occur too. If they used more efficient technologies food and water accessibility would improve.

The domestic use of renewable energy technologies has really big impact on livelihoods in rural areas. Furthermore, the greater access to energy for domestic use also has remarkable impact on rural communities.

Clean water is provided by the application of electric water pumps, which also helps to decrease a lot of efforts (which are needed) for collection.

It is also a social impact that in rural health clinics and hospitals, the operation of medical equipment and the refrigeration of vaccines could be achieved by renewable energy sources.

If television and radio would be available for rural people it can cause improvement in the field of education and entertainment (which is also very important to every people, mainly children).

It would be better if the people who live in rural areas applied electric lighting. Electric lighting is better than old kerosene lanterns. The electric lighting provides more light than old lamps. The people could work more easily if they use these lamps. It would offer good options, for example safety, better security, comfort and more study time. The more study time means that they could learn easily for example at night. [2]

Social capital's goal is to understand the role of a school in the community.

Providing education to all civilians is the main goal of the Finnish basic education. The geographic residence or socioeconomic background does not matter in this viewpoint.

As we can read in a book which was written by Autti O. and Hyry-Beihammer E. K. [4]: "Rural schools (in this article also village schools) have formed a meaningful part of this effort to ensure educational equality, providing good basic education possibilities in sparsely populated rural areas. These schools have also been the heart of their villages' social life."

Unfortunately, many rural schools were closed by the government in rural areas.





In the late 1960s a lot of small schools were closed. The reason for closing them was the decline of birth rates.

The closures of the small rural schools was experienced in a lot of places, for example: mainly it was experienced in Finland, furthermore, in the United Kingdom and Scandinavian countries.

Fortunately, at the end of the 1970s the situation became better related to small rural schools, when the current comprehensive school system was founded and educational equality was meant to ensure equal educational opportunities for all citizens (Kalaoja & Pietarinen, 2009).

Every student can get appropriate education that corresponded to his or her prerequisites and expectations. [4]

I will cite from Autti O. and Hyry-Beihammer E. K. 's book [4]: “The Finnish state ended additional funding for small schools in 2006, which led in turn to municipalities’ closing local schools to solve financial problems. The effects were visible in the 2006 figures for school closures: A record 186 schools were reported closed (Official Statistics of Finland, 2007)”

### 1.4.3. Pedagogical Guide

In the following pages a pedagogical guide is going to be presented in the topic of how to use the three mock-ups in our teaching method, what is the pedagogical goal of each renewable energy class and some didactic tips and tricks are listed in this chapter.

The concrete construction steps of mock-ups are presented in 2.2 Construction guide chapter.

The subchapters follow the same structure in order to facilitate the work of teachers, youth workers and instructors.

#### 1.4.3.1. Domestic Water Heater Mock-up

##### *Goal of the class*

Firstly, the workshop aims to let the participants experiencing the heating power of the Sun. Moreover; the goal is to gain a deeper understanding of domestic hot water producing system. Last but not least, it is important to understand the dependence of humanity on energy sources, as well as the unpredictability of renewable energy sources.

As an output, a mock-up of homemade water heating system (Figures 14) will be produced by groups of the participants.

##### *Pedagogical goal*

The pedagogical goal is double. Once, deepening the knowledge on hot water producing systems, second is improving the manual skills and chic of participants through tinkering and working with do-it-yourself crafts.

##### *Keywords*



#Thermosiphon, #Domestic hot water, #Water heating, #DIY craft

### *Age*

The suggested age of students is 9-12 years. With more scientific explanation and more individual (craft)work, older students can enjoy the class also.

### *Group (number of participants)*

The ideal is forming groups of 3-6 students, or as much as can work comfortably around one table.

### *Time*

Duration of the class: 2h

Preparation time: 2h

Results in (time): 1.5-5h

### *Location, classroom requirements*

Craftworks are preferably done in classroom or in equipped workshop. To test the thermosiphon mock-up in real life conditions, direct sunshine is needed. Thus, if does not enter enough sunshine into the classroom, it is recommended to place the ready mock-ups outside and adjust the inclination hourly in order to make the thermosiphon system facing directly to the Sun.

### *Concrete goal of the class*

We are aiming to build a mock-up of a domestic water heater system, made of recycled materials, materials from the household and some basic materials collected from specific stores.

### *Working mechanisms of the real life cases:*

Domestic water heater systems are usually placed on the roof of houses or other buildings, facing to the South. They collect the sunbeams, the glasshouse effect multiplies its heating power, the water temperature is increasing, warmer water is lifted up and that starts the circulation in the whole system. After a few hours the water tank is accumulating more and more hot water, less and less cold water, thus the average temperature is increasing. We are going to make a model working on the same thermosiphon mechanism (see Figure 14).

### *There are three main parts of the model.*

- Box

The box serves to encase the tubes filled with water and to collect and accumulate the heat. For this reason it is isolated from five sides, has a layer of aluminium in order to reflect the rays of the Sun and is covered by plastic glassware (or polymethyl methacrylate) favouring the greenhouse effect inside the box, thus allowing to reach the highest temperature possible. Inside the box the tubes are interconnected and the two main thick tubes have two outputs: one where the colder water enters on the bottom of the box, and one where the warmer water exits, close to the top of the box. Between the two, many thin tubes ensure the connection.

- Tubes

There are two types of tubes: a thin one (type 1) and a thick one (type 2). The thin tubes serve to distribute the best possible the water and ensure big surface for heat catching. The thermosiphon effect raises the hot water through these thin tubes. The thick tubes connect the thin tubes and the container on two ways: from the bottom part of the container to the bottom part of the box brings the colder water, from the upper side of the box to the upper side of the container brings the warm water.

- Container

The container serves to store the water. It is suggested to isolate well with foam rubber or even better with multilayer insulation. Serious temperature differences can be detected after some hours compared to the initial temperatures (and also between the upper layer of water and the layer at lower level inside the container). It is the result of the thermosiphon effect, in real life cases it happens the same way. On the top, the container should be covered with a removable tap in order to avoid heat losses and staying able to measure temperature throughout the experiment. Be careful by touching the water! The temperature can increase until 60°C. It has to be mentioned that it is the usual temperature of (electric) boilers.

#### *Preparation before the class*

- Buy the specific material and collect the rest from your household
- Check the tools (availability, status, condition)
- Suggested: prepare your own thermosiphon system before the class in order to have your own experience on the topic
- Check tips and tricks
- Optional: if you have the opportunity to introduce the topic on the previous class, you can give some handouts or suggest some videos or links to the students to be observed; favouring this way that they come prepared to the class.

#### *Lesson Plan*

- Arrange the workshop or classroom. Distribute materials, tools and handouts if any
- Start the class
  - Introduce the topic starting from global problems and highlighting the importance of nature awareness and renewable energies. You can use interactive methods, like brainstorming or mind mapping to reveal the existing knowledge of students.
  - Provide the students with accident prevention instructions. Depending on their age and abilities you may prepare some material for them (for instance if they are not prepared to use a drill, drill the holes on their material before).
- Environmental background
  - You might start with listing the different impacts, how the Sun influence our life (light, heat) and its' consequences (sunburnt skin, drying, discolouring clothes, etc.)
  - You may bring other examples or experiments to prove the power of the Sun
  - Turn to the topic of renewable energy usage of Sun. The two most common ways are:

- Producing electricity with the help of photovoltaic panels
    - Heating domestic water up
  - Tell your students, that they are going to see how the heating power of Sun can be multiplied and used for heating water up.
- Start constructing the pilot model (see 2.2 *Construction guide* steps)
  - There is a possibility to arrive to the class with two teacher's models:
    - One that is readily built up, this one we can put under the Sun at the beginning of the class. Note the temperature of the water in the container, the ambient air temperature and the time. During the class check it, note down the measured temperatures and adjust the inclination hourly.
    - The other teacher model would be in particles to make easier the explanation towards the class.
  - You might show first to students your ready model in order to let them know how the result should be by the end of the workshop
  - Dismount your model or take your second teacher's model
  - Go step-by-step, show them the first steps at your desk and tell them to replicate it on their own models in groups. Raise their attention to the importance of cooperation and task sharing inside the group (and on class level too).
  - Go around the tables and observe students' work. In case of need of help, give them a hand and encourage them to solve some of the challenges individually.
  - When one section is done, go with the next steps of the 2.2 *Construction guide*. Show them the next steps at your desk and then let them to repeat the steps on their own model.
  - When a group is ready, go out to the school garden or place the mock-ups under the Sun for testing.
- Testing the model

It's time to try in real life our thermosiphon system.

  - Bring the box outside.
  - Place the mock-up towards the Sun, precise inclination in order to reach the highest possible exposure.
  - Set water container at a higher position then the box. Fill up with water; let the tubes to be filled up. By moving and slightly shaking the mock-up, ensure that no air stays in the system. Make sure you fully cover both sinkers.
  - Measure the temperature in the container and measure the ambient temperature too, note it down, including the time.
  - Come back in one hour and measure the same temperatures, note them down.
  - Adjust the angle of the box to the position of the Sun.
- Conclusions
  - Encourage your students to derive their conclusions based on the data they have
  - Help them by asking the following questions: How many degrees difference you measured in total? When was the temperature the highest? Why? Could it increase

further somehow? How? What helped to reach this temperature? Have you used fossil energies to reach this temperature increase?

- Optional: you can start an open conversation or give as homework to redact a text about domestic water heater systems. Would they like to use it when they are going to be adults? Would they encourage their parents to install it on their house? If they consider it a good solution for the climate change caused global problems, what do they think, why don't use everybody these systems? What else is missing?

*Extra information for teachers, instructors, tips and tricks*

- It is worthy to do the activity during the morning hours, then the water has time to heat up, we can reach higher temperatures.
- Your students may check the water temperature between the upper and lower levels of water inside the container
- If it is not a sunny day, we can encourage the students to repeat the experiment another day and take notes of the results
- We can explain to the students, real water heating systems are working on this effect. The main differences are: size (thus the volume of water), more professional isolation techniques, etc. It can be mentioned as a similarity that none of the systems work if there is no direct sunshine.
- 

#### 1.4.3.2. Photovoltaic Energy in Domestic Lighting

*Goal of the class*

The workshop is aiming to let the participants experiencing the solar radiation energy of the Sun and to learn how we produce electricity with the help of photovoltaic panels. The goal is to gain a deeper understanding of photovoltaic energy systems on mock-up and domestic levels. Last but not least, see the dependence on energy sources and the unpredictability of renewable energy sources. As an output, a mock-up of a house equipped with photovoltaic panels will be produced by groups of the participants (Figures 28). The mini photovoltaic cells produce electricity that will be symbolically used for two purposes, once, for lightning (as, buildings need lighting inside) second for mechanical energy and elevation (as in real life we need to lift up people or material to a higher point too).

*Pedagogical goal*

The pedagogical goal is triple. Once, deepening the knowledge on photovoltaic system usage, second, learn basics of electricity, third is improving the manual skills of participants through working with electric appliances, tinkering and working with do-it-yourself crafts.

*Keywords*

#photovoltaic, #solar cell, #electricity, #solar energy

*Age*

The suggested age of students is 14-16 years. With more preparation from the teacher's side, younger students can enjoy the class also.

*Group (number of participants)*

Groups of 3-6 students, or as much as can work comfortably around one table.

*Time*

Duration of the class: 3h

Preparation time: 2h

Results in (time): immediately (in case of a sunny day = enough sunlight)

*Location, classroom requirements*

Craftworks are preferably done in classroom or in equipped workshop. To test the photovoltaic system in real life conditions, direct or at least abundant sunshine is needed (depending on the PV cells used). Thus if does not enter enough sunshine into the classroom, it is recommended to place the ready mock-ups outside and test the results there.

*Concrete goal of the class*

We are aiming to build a mock-up of a house that symbolize a real one in life that is equipped with photovoltaic cells providing electricity inside the house and outside serves as a lift. In our example, inside the house – as in real life too – we use electricity for lighting that four LED bulbs are representing. Outside of the house, there is going to be a “lookout”, and we can elevate the small piece with the help of the motor and thread.

*Working mechanisms of the real life cases:*

Naturally, in reality we use much larger photovoltaic panels (as an average we can say 2m x 1m) and we need inverters to convert the variable direct current output of a photovoltaic panel into frequency alternating current that can be used by a local network. As we are going to see in our example, the solar cells will likely/only function in direct sunlight. It is similar to the real life cases, where electricity is not produced for example during the night. To sort out the energy needs during the night or cloudy days, in most of the installations batteries ensure the energy storage. In our model, we are not going to use inverters, neither battery in order to keep it simple for demonstration.

Along the next points we are going to look through the model’s elements and see how they can help us to reach our pedagogical goal.

*Do-it-Yourself (DIY) part*

The wooden made house is serving as a close-to life example, but might be different depending on personal fancy. In our example inside the house there is darkness and the walls are covered by aluminium foil in order to reflect the LEDs’ light. The roof of the house is at angle of 35-45° as in real life (this is the usual inclination for solar panels). In real life they are usually facing to the South, however our mock-up will function the best when it faces directly to the Sun.

Wooden craftwork requires accuracy in manual work, attention and caution from students. Working with saw, drill and cutting pliers develop the motor abilities and increase focusing capacity.

In our example, we aim rural schools with this workshop. Students from rural areas are still more connected to nature and craftworks, however, in urban areas of Castellón province students maybe need more help from the adult. For these students it is a good practice to bring closer manual work to them, in some cases, only by touching and working with different materials (wood, metal, plastic, etc.) can activate the different parts of their brain and can help students with learning difficulties.

### *Electrician work*

One of the main aims of this workshop is teaching about electricity and familiarizing students with basic electricity rules as parallel or serial connection, working mechanisms of switches, LED lights and resistors, as well as the usage of soldering iron and tin.

This part of the class will require some previous knowledge in the topic; therefore depending on the age and knowledge of students, we may split the class into several parts and focus on one element at once.

From the electricity part of the workshop, students will understand better how renewable energies – in this case the Sun energy – can be converted to electricity. Also, they are going to learn about the electricity usage inside the house, consumption and the potential of electricity producing solar cells.

Caution: Your students need to pay particular attention when using the saw, the drill, the soldering iron to avoid injuries and accidents. As they are going to work with 6 V solar cells, the danger of electric shock is not occurring.

### *Preparation before the class*

- Buy the specific material and collect the rest from your household
- Check the tools (availability, status, condition)
- Suggested: prepare your own photovoltaic system before the class in order to have your own experience on the topic
- Check tips and tricks
- Optional: if you have the opportunity to introduce the topic on the previous class, you can give some handouts or suggest some videos or links to the students to be observed; favouring this way that they come prepared to the class.

### *Lesson Plan*

- Arrange the workshop or classroom. (Distribute materials, tools and handouts if any)
- Start the class
  - Introduce the topic starting from global problems and highlighting the importance of nature awareness and renewable energies. You can use interactive methods, like

- brainstorming or mind mapping to reveal the existing knowledge of students on photovoltaic topics.
- Provide the students with accident prevention instructions. Depending on their age and abilities you may prepare some material for them beforehand (for instance if they are not prepared to use the drill, drill their holes before).
  - Environmental background
    - You might start with listing the different impacts, how the Sun influences our life (light, heat) and its' consequences (sunburnt skin, drying, discolouring clothes, etc.)
    - You may bring other examples or experiments to prove the power of the Sun
    - Turn to the topic of renewable energy usage of Sun. The two most common ways are:
      - Producing electricity with the help of photovoltaic panels
      - Heating domestic water up
    - Tell them that on this class you are going to see how we can generate electricity with the help of photovoltaic panels.
  - Start the construction of the pilot model (see 2.2 *Construction guide* steps)
    - You may find worthy to arrive to the class with two teacher's models:
      - One that is readily built up, this one we can put under the Sun at the beginning of the class and see what is the goal at the end of the workshop
      - The other teacher's model would be in particles to make easier the explanation towards the class.
    - You might show first to students your ready model in order to let them know how the result should be by the end of the workshop
    - Dismount your model or take your second teacher's model
    - Go step-by-step, show them the first steps at your desk and tell them to replicate it on their own models in groups. Raise their attention to the importance of cooperation and task sharing inside the group (and on class level too).
    - Go around the tables and observe students' work. In case of need of help, give them a hand and encourage them to solve some of the challenges individually.
    - When one section is done, go with the next steps of the 2.2 *Construction guide*. Show them the next steps at your place and then let them to repeat the steps on their own model.
    - When a group is ready, go out to the school garden or place the mock-ups under the Sun for testing.
  - Testing of model

It's time to try in real life our photovoltaic system.

    - Bring the mock-up outside.
    - Place the roof (so the solar cells) facing directly to the Sun (perpendicular to the light rays, in order to reach the highest possible exposure)
    - Move one switch to ON
    - If you did everything well, one LED switches on





- Repeat the same with the other switches and LEDs
  - If there is enough (sun)light, you can switch on all the LEDs
  - Observe if there are any differences among the LEDs (strength of light or anything else)
  - Move the fifth (3 stage) switch to one direction and then try to the other direction as well.
  - Observe how the figure lifts up to the “lookout” and how turns back to the ground level.
  - Try whether there is enough sunshine to make all of them functioning.
  - Observe what happens if you slowly start to move the roof away from the sunshine. Move it to the shadow until none of the LEDs lights or the motor has not enough power to lift the piece. You might try it inside the classroom too.
- Conclusions
    - Encourage your students to derive their conclusions based on the experience they observed
    - Help them by asking the following questions: How much sunlight is needed to have all the LEDs switched on? And for the elevator? What would happen if we removed one solar cell?
    - Optional: you can start an open conversation or give as homework to redact a text about domestic water heater systems. What are the most common (electricity) consumers in our homes? Could they imagine to live in an off-grid (so solar energy powered) house? If they consider it a good solution for the climate change caused global problems, what do they think, why don't use everybody these systems? What else is missing in their opinion?

#### *Extra information for teachers, instructors, tips and tricks*

- It is worthy to do the activity during the morning hours, then there is going to be enough light around daytime
- If it is not a sunny day, we can encourage the students to test the model another day and take notes of the results
- We can explain to the students, that real photovoltaic systems are working on the same effect. The main differences are: size (of the panels), usage of batteries and inverters, etc. It can be mentioned as a similarity that none of the systems work if there is not enough sunshine.

#### 1.4.3.3. Aeroelevator

##### *Goal of the class*

The workshop is aiming to let the participants experiencing the power of wind energy. The windmill is going to turn its axis and this energy is going to be transformed into potential energy: the small piece is going to be lifted up.

As an output, a mock-up of a windmill (Figures 35) is going to be built by groups of the participants.

#### *Pedagogical goal*

The pedagogical goal is double. Once, deepening the knowledge on wind energy systems, second, improving the manual skills of participants through working with craftwork.

#### *Keywords*

#wind energy, #wind mill, #elevator

#### *Age*

The suggested age of students is 6-12 years.

#### *Group (number of participants)*

Groups of 3-6 students, or as much as can work comfortably around one table.

#### *Time*

Duration of the class: 1-2h

Preparation time: 1h

Results in (time): immediately (in case of a windy day, if not, by blowing the blades)

#### *Location, classroom requirements*

Craftworks can be done in classroom or outside as well. To test the windmill in real life conditions, steady wind is needed blowing from one direction. If it is not a windy day, we can try by blowing the blades or – as a less ecological solution, but serving the test of the experiment – by using a fan.

#### *Concrete goal of the class*

We are aiming to build a mock-up of a windmill that symbolizes in classroom conditions the power of wind energy.

This model is very simple, guaranteeing success in the classroom, uses recycled material and costs practically nothing. In the windmill we did not plan any electrical part in order to make it understandable and feasible by younger students. This model is going to symbolize as the potential in as well the barriers of renewable energies. For these reasons we have chosen this mock-up, providing a solution for schools that aims to teach about renewable energies but dealing with limited budget and/or time.

#### *Working mechanisms of the real life cases:*

The most well-known usage of windmills is/was the classical grain mills and the mills used for water pumping. In the latter case water is pumped out from a well with the use of the windmill connected with a piston, thus the rotational movement is turned into vertical movement. The same effect is symbolized in our example with the exception of lacking the piston. In our model the water is lifted up vertically.

Along the next points we are going to look through the model's elements and see how they can help us to reach our pedagogical goal.

### *Do-it-yourself (DIY)*

The big plastic bottle serves for being used as the tower and foundation. The small one serves to hold the axis. The blades of the windmill are the well known origami-style paper windmills [1] [2] that are turning quite easily even in case of low wind speed. The clip is stuck to the axis and it is used as the “barrel” of the well of the symbolic wind energy based water pump.

Creation of the windmill is quite easy, the only critical point can be when cutting the plastic bottle and we have to warn the students to pay attention when using the cutter or scissor.

Creating something moving is motivating for students; moreover if it is functioning well, it increases the self-confidence. Working with paper, plastic and tools develops the motor and focusing capacity.

### *Preparation before the class*

- Buy or collect the material from your home
- Check the tools (availability, status, condition)
- Suggested: prepare your own eolic system before the class in order to have your own experience on the topic
- Check tips and tricks
- Optional: if you have the opportunity to introduce the topic on the previous class, you can tell a story about old windmills or wind-connected water pump systems; favouring this way that they come packed with curiosity to the class.

### *Lesson Plan*

- Arrange the workshop or classroom (distribute materials, tools and handouts if any).
- Start the class
  - Introduce the topic of wind energy by starting from global problems and highlighting the importance of nature awareness and renewable energies. You might use interactive methods or ask students what they are associating to from the word “wind”
  - Provide the students with accident prevention instructions. Depending on their age and abilities you may prepare some material for them beforehand (for instance if they are not prepared to use the cutter or scissor, cut their bottles before).
- Environmental background
  - You might start by interviewing students, how they feel on a windy day? What are the typical windy places (seashore, big plains or high mountains without vegetation)? How wind is/used to be used in sailing, shipping? Where have they seen modern wind turbines?
  - You may bring other examples or experiments how and why humankind started to use windmills in the history (mill grains, pump water and irrigate).

- Turn to the topic of renewable energy usage in the modern era, when nowadays the huge wind turbines are producing electricity.
- Tell them that on this class we are going to see how people of old times used the power of the wind
- Start the construction of the pilot model (see 2.2 *Construction guide* steps)
  - You may find worthy to arrive to the class with two teacher's models:
    - o One that is readily built up,
    - o The other teacher's model would be in particles to make easier the explanation towards the class.
  - You might show first to students your ready model in order to let them know how the result should be by the end of the workshop
  - Dismount your model or take your second teacher's model
  - Go step-by-step, show them the first steps at your desk and tell them to replicate it on their own models in groups. Raise their attention to the importance of cooperation and task sharing inside the group (and on class level too).
  - Go around the tables and observe students' work. In case of need of help, give them a hand and encourage them to solve some of the challenges individually.
  - When one section is done, go with the next steps of the 2.2 *Construction guide*. Show them the next steps at your place and then let them to repeat the steps on their own model.
  - When a group is ready, try out the windmills
- Testing of model
  - You might go out to the school garden in case of a windy day or just open the window of the classroom. If there isn't enough wind, we can explain to the students, that windmills in real life (nowadays and in the past too) work only when there is enough wind and it is blowing more or less from the same direction.
  - Nevertheless to test our models there are two options. First is blowing the windmills, second is using a fan to generate wind. However this second option is less ecological as we use electricity.
- Conclusions
  - Encourage your students to derive their conclusions based on the experience they observed
  - Help them by asking the following questions: How much wind is needed to have the piece lifted up? What happens when there is too much wind?
  - Optional: you can start an open conversation or give as homework to redact a text about windmills. In which areas is it the most suitable to install windmills? Could they imagine living in a wind energy powered house? If they consider it a good solution for the climate change caused global problems, what do they think, why don't use everybody this systems? What else is missing in their opinion?

*Extra information for teachers, instructors, tips and tricks*



- Your students may try out different windmill styles, with different blade-shapes and at the end of the class their efficiency can be tested.
- However, students can try out by blowing the windmills, we can encourage them to repeat the experiment on a windy day and see the results in real life conditions

## 1.5. Conclusions

### 1.5.1. Conclusion on pedagogical guide

Each of the three workshops aims to enlarge the knowledge on renewable energies in rural schools and each of them has its specific pedagogical goal. Teachers can develop students' abilities with all of them. Depending on age, time, circumstances and the curricula teachers are free to choose the one that fits the best to their personality and their didactical aims. Thus, we cannot conclude which is the best from the three mock-ups, all have their characteristics and advantages.

### 1.5.2. Conclusion on calculations

The part of calculations shows the difference between renewable energies in the sizing of installations. However, all the installations require some general parameters for the dimensioning: energy demand (electricity or heating), quantity of resources (solar irradiation or wind speed and frequency) and features of the equipment (power, efficiency and dimensions). Thus, it can be concluded that renewable energies have a similar structure for the sizing, despite specific differences.

### 1.5.3. Conclusion on Construction guide

The construction steps detail how to build each model. The Aeroelevator model can be considered the easiest to be constructed; the Photovoltaic model might be the most complex because it contains serious electrical manipulations. However, the thermosiphon effect can be showed the most efficiently. If the mock-up is built correctly, the success is almost guaranteed and the increase of water temperature is impressive. Thus, it can be concluded that all the models can be made relatively easily, the choice depends on the time, goal, age of students and also, on the budget we have for the class.

### 1.5.4. Conclusion on Economical calculations

The business described in the present case study is viable and profitable at the first stage for one year and later there are several ways to grow the business to various directions. The three workshops are differing in prices; also there are solutions in terms of decreasing the number of groups per class in order to make it reachable for schools in different financial circumstances.

## 1.6. References

- [1] Kandpal T.C. and Broman L. (2015): Renewable Energy Education A Worldwide Status Review, Stromstad, Strömstad Academy
- [2] Rietbergen J. and Hadjemian N. (2010): Renewable Energy Technologies for Rural Development, New York and Geneva, United Nations
- [3] Nemethy S., Dinya L., Gergely S. and Varga G.: Renewable energy production and use through sustainable ecological cycles in agriculture, Gaia Foundation, Gyongyos and Galgaheviz, Hungary
- [4] Autti O. and Hyry-Beihammer E. K. (2014): School Closures in Rural Finnish Communities, Finland, Journal of Research in Rural Education
- [5] From hydraulic to electric, option 1.: <https://www.youtube.com/watch?v=bI5B6BJrPwk>
- [6] From hydraulic to electric, option 2.: [https://www.youtube.com/watch?v=TXfwZ5\\_kyr4](https://www.youtube.com/watch?v=TXfwZ5_kyr4)
- [7] From hydraulic to electric, option 3.: <https://www.youtube.com/watch?v=g6IN0rLcmP4>
- [8] From eolic to electric, option 1.: [https://www.youtube.com/watch?v=YrgJ3Dj\\_0LM](https://www.youtube.com/watch?v=YrgJ3Dj_0LM)
- [9] From eolic to electric, option 2.: [https://www.youtube.com/watch?v=\\_RSG9qrpcR4](https://www.youtube.com/watch?v=_RSG9qrpcR4)
- [10] From eolic to electric, option 3.: <https://www.youtube.com/watch?v=VQ7cp7gbSPc>
- [11] From photovoltaic to electric, option 1.: <https://www.youtube.com/watch?v=FXocRKM4JwY>
- [12] From photovoltaic to electric, option 2.: <https://www.youtube.com/watch?v=svtNM5VexA4>
- [13] From photovoltaic to electric, option 3.: <https://www.youtube.com/watch?v=EMCvzA4pJdg>
- [14] H disposable plastic spoons <http://www.ebay.com/itm/DISPOSABLE-WHITE-PLASTIC-LOOSE-CUTLERY-FORK-KNIFE-SPOON-CATERING-TEA-PARTY-/331017178895?var=&hash=item4d12294f0f:m:m8jrQWh2J8upz-GMIWC8C9Q>
- [15] H CD: <https://www.gigaplaza.eu/shop/%C3%ADrhat%C3%B3-dvd-lemezek/dvd-r-olcso-irhato-dvd-lemezek2013-06-27-16-30-47/tdk-dvd-r-4,7gb-16x-pap%C3%ADrtokban-1-detail>
- [16] H CD size <http://www.multishapecdrom.com/samples.html>
- [17] H styrofoam <http://www.ebay.com/itm/703075-White-Styrofoam-A4-Photo-Texture-Print-/400451984072?hash=item5d3ccc5ac8:g:1B8AAMXQvJVRWDkj>
- [18] H superglue <http://www.ebay.com/itm/Repair-3g-502-Super-Glue-Instant-Adhesive-Bonding-Strong-Tube-Metal-Toys-Wood-/292090219319?hash=item4401ef0b37:g:1D0AAOSwcdRY90Nn>
- [19] H wooden rod <http://www.ebay.com/itm/10pcs-20cm-Wooden-Arts-Craft-Sticks-Dowels-Pole-Rods-Sweet-Trees-Wood-Stick-8mm-/331903971561?hash=item4d4704b0e9:g:wYoAAOSwRQIXgEok>
- [20] H bigger two plastic rods <http://www.ebay.com/itm/2pcs-ABS-Plastic-Round-Bar-Rods-DIY-Dollhouse-Sand-Table-Model-Craft-Tool-/122342482332?var=&hash=item1c7c2e219c:m:mdtd00QqsEHOQEGIFxQorjA4>
- [21] H smaller two plastic rods <http://www.ebay.com/itm/2pcs-ABS-Plastic-Round-Bar-Rods-DIY-Dollhouse-Sand-Table-Model-Craft-Tool-/122342482332?var=&hash=item1c7c2e219c:m:mdtd00QqsEHOQEGIFxQorjA>



- [22] H plastic piece [https://www.alibaba.com/product-detail/15mm-thick-hdpe-plastic-slab\\_60537245433.html?spm=a2700.7724838.0.0.Qvjnbc](https://www.alibaba.com/product-detail/15mm-thick-hdpe-plastic-slab_60537245433.html?spm=a2700.7724838.0.0.Qvjnbc)
- [23] H generator <http://www.ebay.com/itm/Micro-Physics-Experiment-DIY-Wind-Generator-LED-Small-Dc-Motor-Blade-Holder-EW-/262902526995?hash=item3d36363413:g:yYAAAOSwax5Yyj5M>
- [24] H rubber band <http://www.ebay.com/itm/New-40-Pieces-Practical-Black-Elastic-Rubber-Band-Hair-Tie-Ponytail-Holders-BF-/252398646796?hash=item3ac421b60c:g:k2AAAOSwQjZXQY5f>
- [25] H Crocodile clip [http://www.ebay.com/itm/1M-Long-Alligator-Clip-to-Banana-Plug-Test-Cable-Pair-for-Multimeter-LW/172396562957?\\_trksid=p2047675.c100005.m1851&\\_trkparms=aid%3D555018%26algo%3DPL.SIM%26ao%3D2%26asc%3D40130%26meid%3Dbbbd565b3ffc447e9a81d7dc48fe88b1%26pid%3D100005%26rk%3D2%26rkt%3D6%26mehot%3Dpp%26sd%3D371955725931](http://www.ebay.com/itm/1M-Long-Alligator-Clip-to-Banana-Plug-Test-Cable-Pair-for-Multimeter-LW/172396562957?_trksid=p2047675.c100005.m1851&_trkparms=aid%3D555018%26algo%3DPL.SIM%26ao%3D2%26asc%3D40130%26meid%3Dbbbd565b3ffc447e9a81d7dc48fe88b1%26pid%3D100005%26rk%3D2%26rkt%3D6%26mehot%3Dpp%26sd%3D371955725931)
- [26] H Crocodile clip forceps <http://www.ebay.com/itm/2-4-10Pcs-Alligator-Crocodile-Test-Clip-Clamp-For-Multimeter-Tester-Probe-/172483818676?hash=item2828d634b4:g:9UIAAOSwjDZYd18I>
- [27] H small led diode <http://www.ebay.com/itm/Micro-Physics-Experiment-DIY-Wind-Generator-LED-Small-Dc-Motor-Blade-Holder-EW-/262902526995?hash=item3d36363413:g:yYAAAOSwax5Yyj5M>
- [28] H small pocket knife <http://www.ebay.com/itm/Outdoor-Pocket-Folding-Fruit-Knife-Small-camping-Anti-slip-handle-Blade-Knife-/361985287424?hash=item5448012500:g:MaUAAOSw03IY6LWG>
- [29] E superglue <http://www.ebay.com/itm/FD3764-502-Super-Glue-Cyanoacrylate-Adhesive-Strong-Bond-Fast-Repair-Tool-1pc-/272675773475?hash=item3f7cbe1c23:g:x-gAAOSw9KpW~hXc>
- [30] E CD [https://www.alibaba.com/product-detail/single-layer-style-BD-R-25GB\\_60631437629.html?spm=a2700.7724838.0.0.W28JVg](https://www.alibaba.com/product-detail/single-layer-style-BD-R-25GB_60631437629.html?spm=a2700.7724838.0.0.W28JVg)
- [31] E plastic glass [http://www.ebay.com/itm/WHITE-Plastic-7oz-Disposable-Cups-200ml-Drinking-Glass-Vending-Style-Cup-180cc-/181795975245?var=&hash=item2a53e2704d:m:mlUNB2\\_groNKRDeGQdI\\_NdQ](http://www.ebay.com/itm/WHITE-Plastic-7oz-Disposable-Cups-200ml-Drinking-Glass-Vending-Style-Cup-180cc-/181795975245?var=&hash=item2a53e2704d:m:mlUNB2_groNKRDeGQdI_NdQ)
- [32] E generator <http://www.ebay.com/itm/Micro-Physics-Experiment-DIY-Wind-Generator-LED-Small-Dc-Motor-Blade-Holder-EW-/262902526995?hash=item3d36363413:g:yYAAAOSwax5Yyj5M>
- [33] E crocodile clip <http://www.ebay.com/itm/2PCS-Double-ended-Test-Leads-1M-Alligator-Crocodile-Roach-Clip-Jumper-Wire-/231217683640?hash=item35d5a5deb8:g:gaYAAOSwTM5YuJj>
- [34] E scissors <http://www.ebay.com/itm/PROFESSIONAL-HAIRDRESSING-HAIR-CUTTING-BARBER-SALOON-SCISSORS-6-5-/152116743469?hash=item236add4d2d:g:Ss8AAOSwH09ZIIeu>
- [35] E led diode <http://www.ebay.com/itm/Micro-Physics-Experiment-DIY-Wind-Generator-LED-Small-Dc-Motor-Blade-Holder-EW-/262902526995?hash=item3d36363413:g:yYAAAOSwax5Yyj5M>



- [36]E plastic slab [https://www.alibaba.com/product-detail/Professional-opaque-PVC-white-inkjet-printing\\_60553683904.html?spm=a2700.7724838.0.0.mZKXD6](https://www.alibaba.com/product-detail/Professional-opaque-PVC-white-inkjet-printing_60553683904.html?spm=a2700.7724838.0.0.mZKXD6)
- [37]E hair dryer <http://www.ebay.com/itm/Elle-Travel-Hair-Dryer-HDE15-Cold-Air-2-Heat-and-Speed-Setting-Fold-Away-Handle-/162009056329?hash=item25b87e0449:g:z9kAAOSwhQhY64s8>
- [38]P led diode <http://www.ebay.com/itm/Ultra-Bright-1-8mm-3mm-5mm-8mm-10mm-LED-Diodes-Clear-Lens-Flashing-Flickering-/281491590196?var=&hash=item418a34cc34%3Am%3Amn5bDTuofxSG6pySFMbIpzg>
- [39]P soldering <http://www.ebay.com/itm/220V-110V-75W-936-Power-Iron-Frequency-Change-Desolder-Welding-Soldering-Station-/192134755258?hash=item2cbc1fb3ba:g:-H8AAOSw4CFYz3zN>
- [40]P resistor <http://www.ebay.com/itm/20Pcs-1-2W-0-5W-Metal-Film-Resistor-1-82-91-100-120-150-180-200-220-1-910-Ohm-/192095442830?var=&hash=item2cb9c7d78e%3Am%3AmDQz71gXzKYQdttSDPl8HFg>
- [41]P solar panel <http://www.ebay.com/itm/New-6V-1W-Solar-Panel-Module-DIY-For-Light-Battery-Cell-Phone-Toys-Chargers-/201870519129?hash=item2f006bab59:g:qc8AAOSwc-tY2pbe>

### 1.6.1. References for the pedagogical guide

- [1] <https://www.youtube.com/watch?v=VjpTKrdm5Kc>
- [2] <http://www.paperorigamiblog.com/2013/10/fun-origami-windmill.html>
- [3] Partida Parany, s/n, 12600 La Vall D'Uixó, Valencia
- [4] <http://www.leroymerlin.es/fp/10021662/vidrioplastico-?idCatPadre=9371&pathFamiliaFicha=3608>
- [5] <https://tienda.arelux.com/productos/aislamiento-termico/mejor-aislante-termico-multicapa/>
- [6] Componentes Castalia, Av. Almazora nr. 22, Castellón
- [7] Cebekit - Pack de 4 paneles solares experimentales, juguete educativo, color negro (Fadisel C-0137): [https://www.amazon.es/Cebekit-paneles-solares-experimentales-educativo/dp/B00H98E20U/ref=sr\\_1\\_150?ie=UTF8&qid=1494945102&sr=8-150&keywords=fotovoltaico](https://www.amazon.es/Cebekit-paneles-solares-experimentales-educativo/dp/B00H98E20U/ref=sr_1_150?ie=UTF8&qid=1494945102&sr=8-150&keywords=fotovoltaico)
- [8] [https://www.amazon.es/Sourcingmap-A12081300UX0999-Motor-micro-DC/dp/B009AQLDSS/ref=pd\\_sbs\\_60\\_10?encoding=UTF8&psc=1&refRID=XTW2C34Q6VA8CVVKRFX8](https://www.amazon.es/Sourcingmap-A12081300UX0999-Motor-micro-DC/dp/B009AQLDSS/ref=pd_sbs_60_10?encoding=UTF8&psc=1&refRID=XTW2C34Q6VA8CVVKRFX8)
- [9] <http://www.leroymerlin.es/fp/18896752/tablero-contrachapado-contrachapado?pathFamiliaFicha=4604>
- [10] [http://www.salvadorescoda.com/tarifas/Accesorios\\_Fijacion\\_Catalogo\\_Sept\\_2014.pdf](http://www.salvadorescoda.com/tarifas/Accesorios_Fijacion_Catalogo_Sept_2014.pdf)
- [11] <http://todoeduca.com/estudios/educacionsecundariaobligatoria/castellon.html>



# Calculations and Construction guide



**Compilation of case studies of applying renewable energies to local development transnationally implemented**



Co-funded by the  
Erasmus+ Programme  
of the European Union



## 2. Calculations and Construction guide

The following chapter contains two main parts. Once, the Calculation and design part will show how real life cases would work through theoretical calculations based on hypothetical cases. Second, the three models' Construction guide is attached to this chapter, containing the complete list of required material, including unit price and the construction method step-by-step.

### 2.1. Calculations and design

#### 2.1.1. Calculation of Domestic Water Heater systems

- **Inputs**

Thermal energy is often used in Hot Water systems, working independently or with other heat generators (normally boilers). Normally, the Technical Building Code (CTE, Spain) establish a guide to size the minimum solar contribution for hot water.

In order to size the thermal collectors, the main factors that must be taken into account are:

- Location
- Type of building and occupation
- Type of panels, inclination, orientation and efficiency.

In this example, it is considered that the installation is located in the province of Castellón (Spain) and the building is a single-family household with 4 inhabitants. Following the CTE, the daily consumption of hot water is 22 litres/person.

The solar thermal collector selected is a SOL 2300 XBA of the company ESCOSOL. The dimension of the collector is 1.903x1.216 m and its efficiency is 0.749. It is selected a recommended inclination of 45° and South orientation.

- **Irradiation and orientation**

The average daily irradiation  $H$  (Wh/day·m<sup>2</sup>) of Castellón is obtained from the PVGIS:

Table 1 – Average monthly irradiation

Month	$H_h$
Jan	2290
Feb	3240
Mar	4740
Apr	5640

May	6630
Jun	7420
Jul	7350
Aug	6350
Sep	4950
Oct	3760
Nov	2570
Dec	2000
Year	4750

The average value of Castellón is 4750 Wh/day·m<sup>2</sup>, which is 4087 kcal/day·m<sup>2</sup>.

The inclination corrector factor (K) for latitude of 40° is shown in the next table (source: CENSOLAR):

Table 2 – Inclination corrector factor

Incl°	ENE	FEB	MAR	ABR	MAY	JUN	JUL	AGO	SEP	OCT	NOV	DIC
0	1	1	1	1	1	1	1	1	1	1	1	1
5	1,07	1,06	1,05	1,03	1,02	1,01	1,02	1,03	1,05	1,08	1,09	1,09
10	1,14	1,11	1,08	1,05	1,03	1,02	1,03	1,06	1,1	1,14	1,17	1,16
15	1,2	1,16	1,12	1,07	1,03	1,02	1,04	1,08	1,14	1,21	1,25	1,24
20	1,25	1,2	1,14	1,08	1,03	1,02	1,03	1,09	1,17	1,26	1,32	1,3
25	1,3	1,23	1,16	1,08	1,02	1	1,02	1,09	1,19	1,3	1,38	1,36
30	1,34	1,26	1,17	1,07	1,01	0,98	1,01	1,09	1,2	1,34	1,43	1,41
35	1,37	1,28	1,17	1,06	0,98	0,95	0,98	1,07	1,21	1,37	1,47	1,45
40	1,39	1,29	1,16	1,04	0,95	0,92	0,95	1,05	1,21	1,39	1,5	1,48
45	1,4	1,29	1,15	1,01	0,91	0,88	0,92	1,03	1,2	1,39	1,52	1,5
50	1,41	1,28	1,13	0,98	0,87	0,83	0,87	0,99	1,18	1,39	1,54	1,52
55	1,4	1,27	1,1	0,94	0,82	0,78	0,82	0,95	1,15	1,38	1,54	1,52
60	1,39	1,24	1,07	0,89	0,77	0,72	0,77	0,9	1,12	1,36	1,53	1,51
65	1,37	1,21	1,03	0,84	0,71	0,66	0,71	0,85	1,07	1,34	1,51	1,5
70	1,34	1,17	0,98	0,78	0,64	0,59	0,64	0,79	1,02	1,3	1,49	1,47
75	1,3	1,13	0,92	0,72	0,57	0,52	0,57	0,73	0,97	1,25	1,45	1,44
80	1,25	1,08	0,86	0,65	0,5	0,45	0,5	0,66	0,9	1,2	1,41	1,4
85	1,2	1,02	0,8	0,58	0,43	0,37	0,42	0,58	0,84	1,14	1,35	1,35
90	1,14	0,95	0,73	0,5	0,35	0,29	0,34	0,5	0,76	1,07	1,29	1,29

Therefore, the average value of K is 1.19.

- **Number of solar collectors**

In order to know the number of collectors required, it is necessary to calculate the total area of capture in m<sup>2</sup>. The equation used is:

$$S(m^2) = C \cdot \frac{Ta - Te}{H \cdot K \cdot Rc}$$

Where:

S: Total area of capture in m<sup>2</sup>

$C$ : Daily consumption in litres/day

$T_a$ : Temperature of accumulation in °C (it is considering 60°C, attending to CTE)

$T_e$ : Temperature of entrance in °C (following the UNE 94.002:2005, the average in Castellón is 14.58)

$R_c$ : Efficiency of the collector (0.749)

Considering that:

$$C = 4 \cdot 22 = 88 \text{ litres/day}$$

The value of the total required area is:

$$S = \frac{88 \cdot (60 - 14.58)}{4087 \cdot 1.19 \cdot 0.749} = 1.097 \text{ m}^2$$

The numbers of required collectors are:

$$\text{Number of collectors} = \frac{1.097}{(1.903 \cdot 1.216)} = 0.474$$

Therefore, it is necessary only one solar collector for this example.

### 2.1.2. Calculation of Photovoltaic systems

- **Energy demand**

The first step in order to size a photovoltaic system is to know the daily consumption of energy required. The two parameters required are the power consumption and the operating hours of all the equipments that need energy. The total energy can be calculated as:

$$Ed (Wh) = \sum (P(W) \cdot h)$$

In this example, it is considered a total energy demand of 1 kWh for the sizing of the installation (it is enough energy for domestic lighting).

- **System losses**

All the photovoltaic systems have losses or Performance Ratios (PR) that must be taken into account. The PR can be calculated with the next equation:

$$PR = 1 - (LOSS_{orient} + LOSS_{shade} + LOSS_{dirt} + LOSS_{cable} + (1 - Perf_{inv}) + (1 - Perf_{reg}) + (1 - Perf_{bat}) + LOSS_{deter})$$

Where:

$LOSS_{orient}$ : losses due to orientation.

$LOSS_{shade}$ : losses by shadows.

$LOSS_{cable}$ : losses by wiring.

$LOSS_{dirt}$ : losses by dirt.

$Perf_{inv}$ : performance of the inverter

$Perf_{reg}$ : performance of the regulator

$Perf_{bat}$ : performance of the battery

$LOSS_{deter}$ : losses due to deterioration of the panels.

It is considered a direct generation system because is more similar to the pedagogic model, being also simpler. Normally, a PR of 0,8 is established of direct photovoltaic installations.

- **Sizing of the photovoltaic field**

In order to define the number of PV panels to be installed, it is required to know the irradiation of the area. This irradiation is obtained from official databases, depending on the region. One of the most important databases in Europe is PVGIS (Photovoltaic Geographical Information System).

This tool can serve for the estimation of the performance of grid-connected PV, monthly radiation, daily radiation or stand-alone PV. For this simple case, it is used the PV Estimation tab.

It is necessary to establish a value of peak PV for the installation. It is considered Atersa A250P photovoltaic modules (manufactured close to the location).

The required parameters for the PV estimation are shown in the next table:

Table 3 – Required parameters for photovoltaic estimation

Parameter	Value
Location	Province of Castellón
PV technology	Crystalline silicon
Installed peak PV power	0.5 kWp
Estimated system losses	20 %
Slope	30°

This information is introduced in the PVGIS:

Table 4 – Data for PVGIS

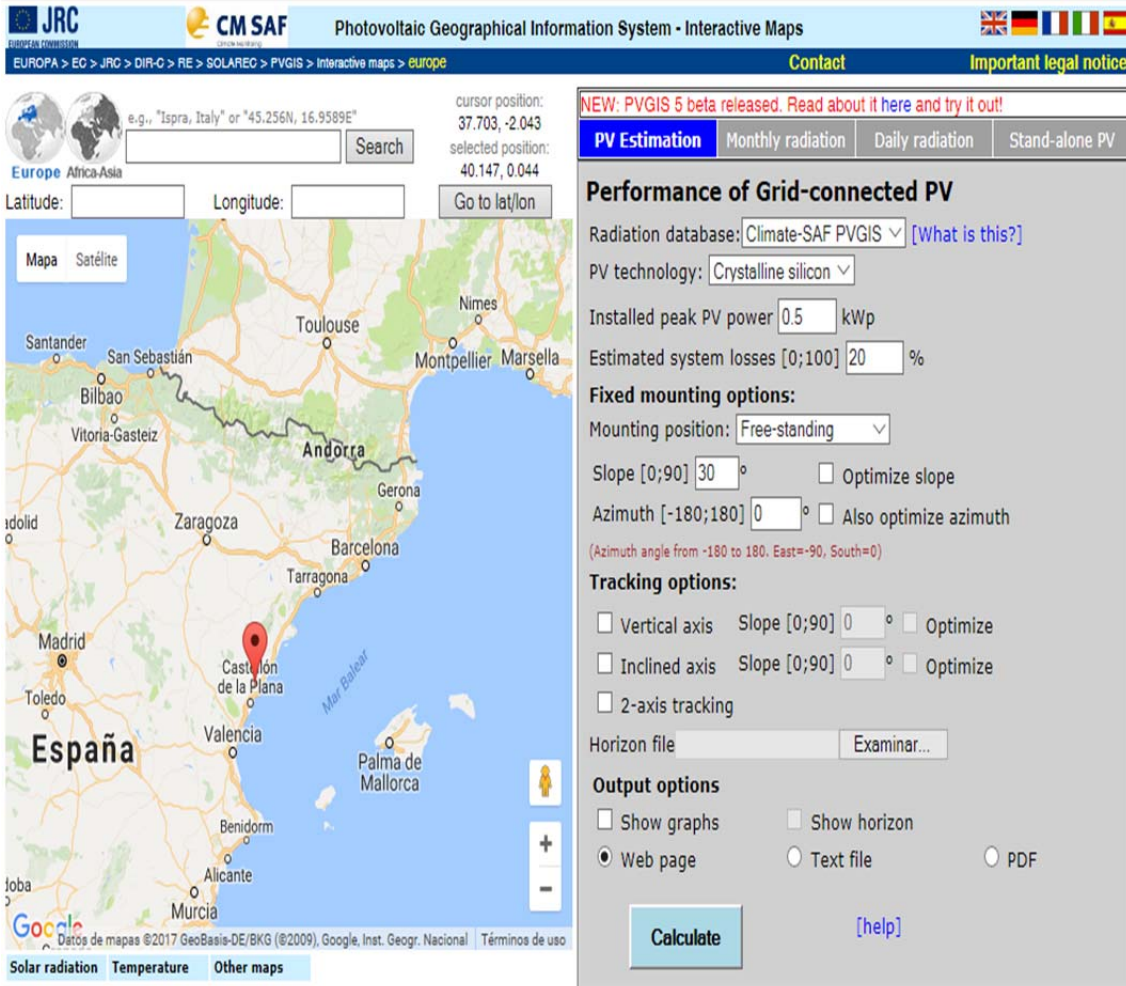

The screenshot shows the PVGIS web interface with the following configuration:

- Location:** Castellón de la Plana, Spain (Coordinates: 40.147, 0.044)
- Radiation database:** Climate-SAF PVGIS
- PV technology:** Crystalline silicon
- Installed peak PV power:** 0.5 kWp
- Estimated system losses:** 20 %
- Fixed mounting options:**
  - Mounting position: Free-standing
  - Slope [0;90]: 30° (Optimize slope: )
  - Azimuth [-180;180]: 0° (Also optimize azimuth: )
- Tracking options:**
  - Vertical axis:  Slope [0;90]: 0° (Optimize: )
  - Inclined axis:  Slope [0;90]: 0° (Optimize: )
  - 2-axis tracking:
- Output options:**
  - Show graphs:  Show horizon:
  - Web page:  Text file:  PDF:

The **Calculate** button is visible at the bottom of the configuration panel.

The installed peak PV power is equivalent to two Atersa modules of 250 Wp. The results given by the PVGIS are:



Table 5 – Results of PVGIS

<b>Fixed system: inclination=30°, orientation=0°</b>				
<b>Month</b>	<b><math>E_d</math></b>	<b><math>E_m</math></b>	<b><math>H_d</math></b>	<b><math>H_m</math></b>
Jan	1.37	42.3	3.68	114
Feb	1.73	48.5	4.71	132
Mar	2.14	66.4	5.96	185
Apr	2.15	64.6	6.12	184
May	2.29	71.0	6.60	205
Jun	2.40	72.0	7.02	211
Jul	2.38	73.7	7.05	219
Aug	2.23	69.1	6.62	205
Sep	1.98	59.4	5.78	173
Oct	1.75	54.1	4.99	155
Nov	1.45	43.5	4.00	120
Dec	1.25	38.9	3.38	105
<b>Yearly average</b>	<b>1.93</b>	<b>58.6</b>	<b>5.50</b>	<b>167</b>
<b>Total for year</b>		<b>704</b>		<b>2010</b>

Where:

$E_d$ : Average daily electricity production from the given system (kWh).

$E_m$ : Average monthly electricity production from the given system (kWh).

$H_d$ : Average daily sum of global irradiation per square meter received by the modules of the given system (kWh/m<sup>2</sup>).

$H_m$ : Average sum of global irradiation per square meter received by the modules of the given system (kWh/m<sup>2</sup>).

Comparing the average monthly electricity production from the system with the energy demand considered, it is obtained the next graph:

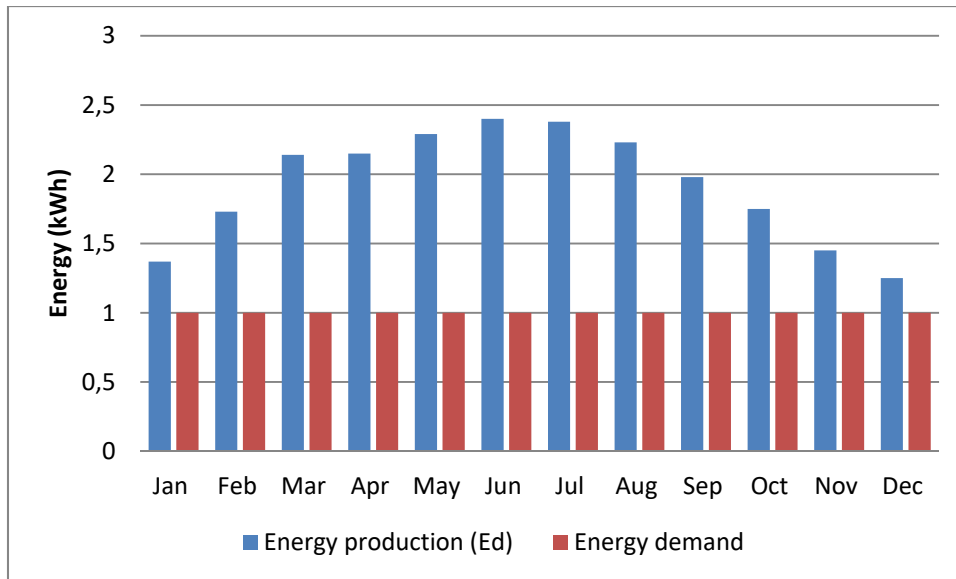

Graph 1 – Energy demand and average daily electricity production per month

It is shown that the PV installation provides enough energy for the supplying of the demand. Nevertheless, in order to do a correct study, it must be considered the daily radiation because solar systems do not produce energy during the night. However, for this example the results are valid.

### 2.1.3. Calculation of wind turbine systems

- **Energy demand**

The energy demand is calculated as it is shown in the point “2.1.2 Calculation of photovoltaic systems”. In this example, in order to size a wind turbine, it is considered a daily energy demand of 1 kWh/day for lighting.

- **Wind energy potential**

The calculus and sizing of the wind installation is based on different maps and historic databases of wind. For example, the Institute of Diversification and Saving Energy (IDAE, Spain) has different wind maps.

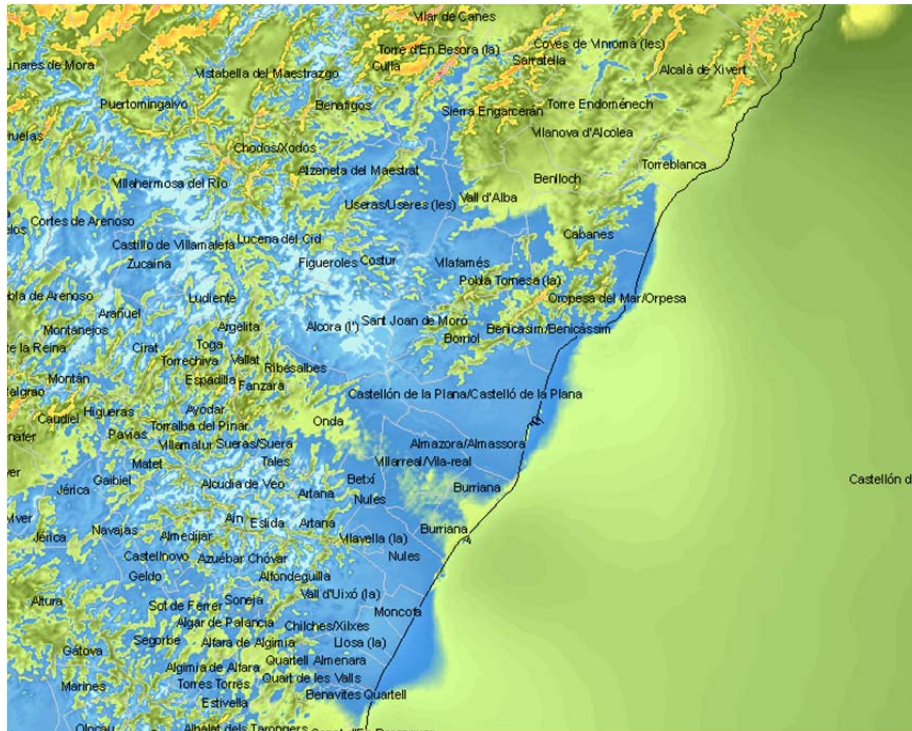

Map 1 - Average wind speed in the province of Castellón

Moreover, IDAE also allows the calculus of the wind rose diagram selecting one point in the map. The database gives information about the average frequency and speed in every direction:

Table 6 – Average wind frequency and speed in every direction

Direction	Frequency (%)	Speed (m/s)	Power (%)	Weibull C (m/s)	Weibull K
N	7.33	4.952	8.67	5.807	1.834
NNE	6.42	4.935	7.51	5.757	1.812
NE	5.12	4.775	6.13	5.545	1.646
ENE	4.26	3.939	3.31	4.681	1.569
E	4.77	3.37	1.43	3.883	2.147
ESE	6.6	3.258	1.57	3.742	2.485
SE	9.18	3.349	2.29	3.863	2.681
SSE	8.12	3.426	2.41	4.01	2.442
S	4.68	2.952	1.06	3.52	2.105
SSW	3.74	2.97	0.95	3.56	1.949
SW	4.19	3.409	1.81	4.06	1.742
WSW	4.73	3.853	3.14	4.545	1.64
W	5.88	4.383	5.72	5.186	1.654
WNW	7.56	5.198	10.95	6.035	1.718
NW	7.25	4.819	9.01	5.747	1.724
NNW	10.2	6.693	34.05	7.838	1.661

The wind rose diagram is the representation of the frequency and speed in this location:

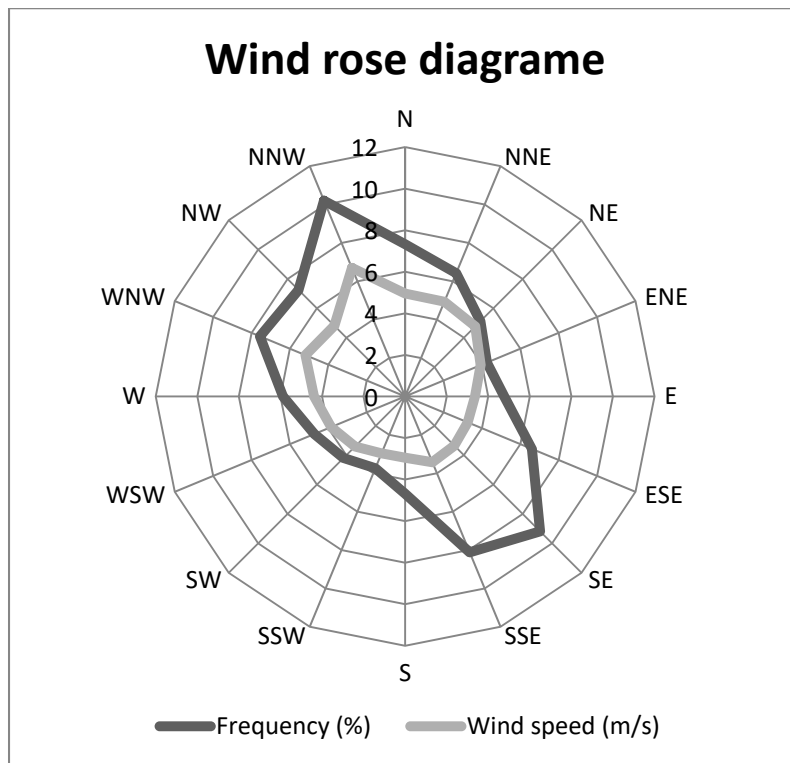

Graph 2 - Wind rose diagram

Moreover, another important tool is the database provided by National Centre of Renewable Energies (CENER, Spain). In this database can be extracted the histogram of frequency and speed of the wind. Knowing the frequency of the wind, the yearly hours of wind can be obtained as the number of wind hours per frequency.

Table 7 – Wind speed, frequency and windy hours/year

Speed (m/s)	Frequency	Hours/year
0.5	1.5%	128.77
1.5	14.0%	1201.87
2.5	24.0%	2060.35
3.5	25.0%	2146.20
4.5	14.0%	1201.87
5.5	8.0%	686.78
6.5	5.0%	429.24
7.5	3.0%	257.54
8.5	1.5%	128.77
9.5	1.0%	85.85
10.5	1.0%	85.85

11.5	0.0%	0.00
12.5	0.0%	0.00
13.5	0.0%	0.00

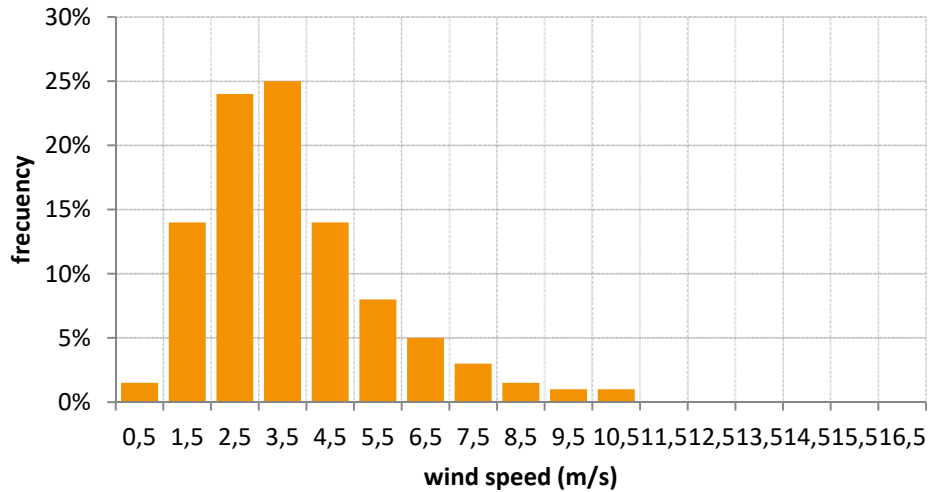

Graph 3 - Wind speed and frequency

- Selection of the wind turbine**

For this example it is not required a wind turbine with big nominal power. It is selected the Enair 30Pro of Enair Energy S.L. The main characteristics are the following:



Graph 4 – Characteristics of selected wind turbine

Table 8 - Characteristics of selected wind turbine

Enair 30PRO		Speed (m/s)	Cp
Number of blades	3	0.5	0
Material of blades	Glass fiber with resins and polyurethane core	1.5	0.000
Generator	250rpm nominal Neodymium magnets	2.5	0.046
Power	3000W	3.5	0.034
Nominal power	1900W (IEC 61400-2)	4.5	0.474
Tension	24 / 48 / 220V	5.5	0.562
Wind class	CLASS I / IEC 61400-2 / NVN I - A	6.5	0.524
Turning sense	Schedule	7.5	0.410
Swept Area	11,34m <sup>2</sup>	8.5	0.363
Wind to Start	1,8m/s	9.5	0.319
Rated Speed	11m/s	10.5	0.249
Speed variable pitch regulation	12m/s	11.5	0.204
Supported Speed	60m/s	12.5	0.170
Efficient generation range	From 2 to 60m/s	13.5	0.146
Type	Windward horizontal windward axis rotor	14.5	0.118
		15.5	0.097
		16.5	0.080

The values of the Coefficient Power (Cp) are obtained from the Power curve given by the manufacturer.

- **Wind power generation**

The power supplied by the wind turbine depends on the Coefficient Power (Cp), the swept area ( $A = 11.34 \text{ m}^2$ ), and the wind speed ( $v$ ), considering constant the air density ( $\rho=1.225 \text{ kg/m}^3$ ). The equation used is:

$$P (W) = \frac{1}{2} \cdot Cp \cdot \rho \cdot A \cdot v^3$$

Considering the data of the manufacturer, the power that can be produced by the wind turbine is:

Table 9 - Power produced by the wind turbine

Speed (m/s)	C <sub>p</sub>	P (W)
0.5	0	0
1.5	0.000	0
2.5	0.046	5
3.5	0.034	10
4.5	0.474	300
5.5	0.562	650
6.5	0.524	1000
7.5	0.410	1200
8.5	0.363	1550
9.5	0.319	1900
10.5	0.249	2000
11.5	0.204	2150
12.5	0.170	2300
13.5	0.146	2500
14.5	0.118	2500
15.5	0.097	2500

The total energy produced is the multiplication of the power and the number of hours per year:

Table 10 - Total energy produced

Speed (m/s)	E (Wh/year)
0.5	0
1.5	0
2.5	10301.76
3.5	21462
4.5	360561.6
5.5	446409.6
6.5	429240
7.5	309052.8
8.5	199596.6
9.5	163111.2
10.5	171696
11.5	0
12.5	0
13.5	0
14.5	0
15.5	0
<b>TOTAL (kWh/year)</b>	<b>2111.43156</b>

Therefore, the annual energy produced by one Enair P30 is 2111.43 kWh/year. This means that the daily energy production is:

$$\text{Daily energy} = 5.78 \frac{\text{kWh}}{\text{day}}$$

We can see that the smallest model of the company Enair can give more energy than the necessary, so it is only required one wind turbine.



## 2.2. Construction guide

In this chapter the concrete construction steps are shown step-by-step in order to give a hand to the workshop leader and the students. At the end of each of the three mock-ups, photo illustration helps to learn more about the important points. At the very end (*5 Project plans*) of the present case study, layouts help the best reconstruction of the mock-up built by us. However, these have to be considered as guides, several variations of the mock-ups exist depending on personal fancy and possibilities. We encourage teachers and workshop leaders to experiment with other solutions.

### 2.2.1. Domestic Water Heater Mock-up

The workshop aims to let the participants experiencing the heating power of the Sun. As an output, a mock-up of homemade water heating system will be produced by groups of the participants.

- **Required tools**

- Drill
- Scissor and cutter
- Thermometer
- Glue or silicone
- Punch (to make holes)

- **Required material**

Table 11. List of materials for Domestic Water Heater Mock-up

Required material	Suggested size	Pieces	Approximate price (for one unit)	Preferred characteristics	Where to get it from?
Box	30x50 cm	1	0	Wood	Greengrocer
Container (plastic water can)	5 liter	1	0	Plastic/non-corrosive metal	Household
Tube type 1 (thin)	Length: 10-12 m	Diameter: 4 mm	0.5 €	Black plastic	Cooperative or other garden shop
Tube type 2 (thick)	Length: 1.2 m	Diameter: 16 mm	0.5 (4 € /25 m)	Black plastic	Cooperative or other garden shop
Glassware or polymethyl methacrylate	30x50 cm	1	3 € (9 € / 1x 0.5mx 2.5 mm piece)	Transparent, few mm thick, rigid	Leroy Merlin
Foam rubber	50x30x2 cm 55x10x2 cm 37x10x2 cm	1 2 2	0	Bottom of box Side Side	Household, old wrapping of electro domestic

	55x5x2 cm 30x5x2 cm 14x14x2 cm	2 2 1		Top Top Top of the container	machines for example
Multilayer insulation (13 layers)	67x15 cm 22x15 cm	1 1	11,15 €/m <sup>2</sup>	Fitting to the size of container	Construction store, Arelux for example
Small joints (between tube type 1 and 2)	4 mm	2x22=44	1.8 € (0.039 € /piece)		Cooperative or other garden shop
Big joints (between tube type 2 and 2)	16x16 mm	4	0.1 € (/piece)		Cooperative or other garden shop
Cable gland	See link	2	2.9 € (/piece)	3/4	Cooperative or other garden shop
Thread connection	See link	2	0.2 € (/piece)		Cooperative or other garden shop
Cover for the tubes type 2	Diameter: 16 mm	2	0.06 € (/piece)		Cooperative or other garden shop
Aluminum foil	50x70 cm	1	0	Fitting to the box from inside	Household

The model is built from the following materials or was bought in the following stores (see addresses or links among *1.5 References*)

- Cooperative Agricol San Vicent [3]
- Leroy Merlin [4]
- Multilayer insulation [5]

- **Construction step by step**

There are going to be 3 main steps:

- Prepare the box
  - Adjust the box if needed. In our example the box was too much high compared to the needs, thus we cut it to the height of 10 cm. We used a simple, (standard 50x30 cm), fruit carrier wooden box (Figure 1)
  - Drill or cut the box on the sides: once where the tube enters and second where the hot water tube exit. In some cases you might need space for the taps at the end of the thick tubes; in this case you may drill two additional holes. (Figure 2)
  - Cut the foam rubber to the size of the box. It is possible to cover the box from 5 sides (bottom and the 4 vertical side walls), that would ensure better isolation for

- the system. Put the foam rubber inside the box, glue it if needed. Make sure you let room for the leaving tubes (Figure 3).
- Cover the box inside with aluminium paper, the sides too.
  - When the tubes will be inside the box, we will have to cover the box with plastic glassware or polymethyl methacrylate to ensure the glasshouse effect inside the box. (Figure 7)
  - In our example the bottom of the isolation is inside the box, and the walls are covered from outside of the box. To ensure the best isolation inside the box, after gluing the glassware on the top, we covered it again from the top as a “frame”. (Figures 8-9-10-11)
- o Prepare the tubes
    - Cut the tubes. The tube type 1 is a thin, flexible, possibly black plastic tube. The tube type 2 is a thicker, more rigid, possibly black plastic tube. Sizes always depend on the size of the box. Adjust the length of the tubes, if you cannot find the same size of box.
    - Place the two (30 cm long) thick plastic tube parallel on the table, approximately 50 cm apart. Pin the thick tube with the small joints in one line, equal distance apart (1-2 cm) (Figure 5). The more joints we can pin, the more efficient will be our thermosiphon. In the example we used 22 joints, you are free to do as much as you can. Repeat the same with the other thick tube. Attach the thin tubes with the small joints, one by one by creating the connection between the two thick tubes.
    - Close the thick tubes with the cover. In our example on the top on left hand side and on the bottom on the right hand side.
  - o Prepare the container
    - Cut a 5-8 l plastic water can's top. The best is looking for a bottle that is made of more rigid plastic and has rectangular shape and the sides are flat and smooth.
    - Drill the container and set the cable gland and thread connection in. Screw it tightly. The best repartition is that if you make a hole on one side, close to the top of the container (here is going to enter the warm water) and you drill a hole on the front side, but close to the bottom of the container (here is going to run out the cool water. Be careful at the top hole: the water level has to cover the hole and the tap should fit to the top of container. The suggestion is to drill the hole approx. 5 cm distance from the top.
    - Cover the container the closest possible from the bottom and the four sides. If you cannot ensure it with foam rubber, use multilayer insulation. Let the holes freely as the tubes will be connected here. (Figures 4)
    - Cut the tap out of foam rubber fitting to the size of container
  - o Setting the system up
    - Put the combined thin and thick tubes into the box (on the aluminium foil) (Figure 6)
    - Make the thick tubes exit on the holes you prepared previously on the box
    - Connect with the big joints to the rest of thick tubes and finally

- Connect it to the container (Figure 11)  
Be careful: The box is going to have an inclination, therefore the upper part will collect the warmer water and the cooler water will always be on the bottom part of the system. Therefore the exit of warm water will be on the upper part of the box and will bring the water to the upper part of the container. The Lower part of the container will be connected with the lower part of the box (Figure 13).
- Cover the box with plastic glassware (Figure 7).
- Put the last parts of the insulation as an outer “frame” by closing the possible leakage between the outside foam and the plastic glassware (Figures 8-9-10).
- Put the system to its place, favourably into full Sun in the school garden. Make sure, the container’s bottom is at higher level than the (warm) thick tube
- Fill up the system with water. Make sure all the air exit the system, otherwise it is not going to work (properly). Measure the temperature in the container and outside.
- Cover the container, but be sure you can open it later to measure the elevation of the water temperature.
- Adjust the inclination to the direction of the Sun on an hourly basis (Figures 14).

- *Illustration for construction*



Figure 1



Figure 2



Figure 3



Figures 4



Figure 5



Figure 6



Figure 7



Figure 8



Figure 9





Figure 10



Figure 11



Figure 12



Figure 13



Figures 14

### 2.2.2. Photovoltaic Energy in Domestic Lighting

The workshop is aiming to experience the solar energy and to learn how we produce electricity with the help of photovoltaic panels. As an output, a mock-up of a house equipped with photovoltaic panels producing electricity will be built; the electricity will be used for lightning and elevation.

- **Required tools**

- Drill
- Drill bit (diameter: 6 mm and 8 mm)
- Cutting pliers
- Wrench
- Saw
- Soldering iron
- Tin
- Silicone (or wood-aluminium glue)

Optional for testing:

- Multimeter to measure tension

- **Required material**

Table 12. List of required material for Photovoltaic Energy in Domestic Lighting

Required material	Suggested size	Pieces	Approximate price (for one unit)	Preferred characteristics	Where to get it from?
PV cells	4x4 cm	4	9 € (the pack of 4 cells)	110 mW, 1.5 V75 mA	Amazon (see details below)
Plywood	30x21 cm	1	1.6 € (250 x 122 x 0,5 cm / 24 €)	0.5 cm thick plywood	Household, DIY shop or Leroy Merlin
	30x16 cm	1			
	30x9 cm	1			
	16x13x9 cm	2			
Screws	8 mm	8	0.9 € (1.8 € / 16 pieces)	Length: 6.5 cm	Household or DIY shop
Nut	8 mm	14	0.5 €	Fitting to the screws	Household or DIY shop
LED light	3 Ampere and 6 Volt	4	1.21 € (/ piece)	White, luminous	DIY shop or electric store
Switch	1 cm	4	1.45 € (/piece)	On-off switch	DIY shop or

(type 1)					electric store
Switch (type 2)	1 cm	1	2.4 € (/piece)	3 stages switch	DIY shop or electric store
Electronic resistance	2200 Ω	4	0.1 € (/piece)		DIY shop or electric store
Cable	2 meters	1	0.3 €	Diameter : 0.25 mm	DIY shop or electric store
Insulating tape	40 cm	1	0 (0.65 € / roll)		Household or DIY shop
Motor	1.3 Ampere and 6 Volt, speed 30 rpm	1	12.2 €	Diameter : 12 mm	Amazon or electric store
Threaded rod	20-30 cm	1	1.8 € (3.6 / 2 pieces)	Diameter: 6 mm	Household or DIY shop
Clamp	Diameter: 12 mm	1	0.16 e / piece (13.32 € / 100 pieces)	Connection: 6 mm	Household or DIY shop
Small joint	4 mm	1	0 (0.039 € /piece)	It can be the same that used for the water heater mock-up	Cooperative or other garden shop

The model is built from the following materials or was bought in the following stores (see addresses or links among references)

- Electric store [6]
- Amazon – pv cells [7]
- Amazon – motor [8]
- Plywood [9]
- Clamp [10]
- Joint [3]

### • **Construction step-by-step**

#### ○ Preparation of wooden material (LEDs and elevator)

- Prepare the guiding layouts from the 5 *Project plans* (Figure 15)
- Prepare the next point on this present chapter where you may find the pictures that will help you (2.2.2.4 *Illustration for construction*)
- Draw the following draft of elements on the plywood (see Table 13.):

Table 13. - Preparation of wooden material for Photovoltaic mock-up

<b>Rectangles of the following sizes</b>	30x21 cm (this is going to be the “basement”) 30x16 cm (this is going to be the “roof”) 30x9 cm (this is going to be the “front”)
<b>2 triangles of</b>	16x13x9 cm (these are going to be the two covers from the sides in order to make darkness)

- Cut the above mentioned forms out of plywood with a saw and cover one side by aluminium paper (Figure 15)
- Drill holes on the plywood as indicated in *5 Project plans*
  - o 6 holes of 8 mm diameter
  - o 6 holes of 6 mm diameter for the four on-off switches, the 3 stage switch and the threaded rod (for the elevator)
  - o 8 holes of 4 mm diameter for the four LEDs
- Prepare the screws and the nuts
- In the four corners screw the 4 “legs” of the “basement”. The length of the “legs” can be different, the main aim is to lift the basement in order to be able to do the manipulations with the electric stuff (the bottom part of our switches require minimum 2.5 cm and the cables also need room) (Figures 16-17)
- Turn the nut on the four screws to make it stable
- Continue with the electric part and later come back to finish the “house” (set up the “roof” and the side covering triangles).
- o Preparation of electrical part (LEDs and elevator)
  - Set in the 4 switches and the 3 stage switch in their corresponding holes (Figures 18).
  - Put the 4 white LED diodes in their holes, folding the long pin towards the led on its side and the short pin towards the switches (Figures 19).
  - Weld with a 30W soldering iron a resistance of 2K2  $\Omega$  at the end of each of the switches and the other end of the resistance weld to the short pin of each led diode (Figures 19-20).
  - Weld the neighbouring long pins of the LED diodes between them. At the last pin weld a cable that will go until one of the intermediate pins of the 3 stage switch. You will leave also welded a piece of cable of 40 centimetres to connect to the positive pole of the photovoltaic cells.
  - Weld the other intermediate pin of the 3 stage switch with a cable and drive further the cable and weld it to the free pins of the on-off switches. Leave minimum 30 cm of cable for connect later with the negative poles of PV cells.
  - Look at the 6 pins of the 3 stage switch. You have already connected the two middle pins. Now connect the rest as per the followings: right-up corner pin with

the left down corner. And with another short cable the left-up pin with the right-down pin (Figure 22).

- Get a new pair of cable and weld them to the two down pins and let the rest 55 cm to be connected later to the motor (Figure 22).
  - Now continue with the tinkering part, build the “roof” and the sides.
  - Insert the two 8 mm screws into the two holes that have left in the middle of your basement. These two screws will be the two supporting pillars, so make sure you pin it through from the opposite direction than the four other “legs”. Strengthen it with two nuts. (Figures 23).
- o Decoration and setting the system up
- Place the “roof” on; make sure, the longer side of the “roof” matches with the longer side of the basement and the other side lays on the two “pillars”. You have two options, glue the wooden parts together with silicon, or you drill the two together (while you keep the angle between them around 30-40°). In our example, as you can see on the photos we did like this, however – as they are not regular circles, but rather ellipses on the reason of the angle between the two wooden parts, they do not appear on the mechanical draws (*5 Project plans*).
  - Glue the triangles to the sides and the front piece leaving the window at the bottom (Figures 23).
  - Glue with double-sided tape the solar panels on the “roof”, leaving the cable connections at the top
  - Screw the 40 cm long rod with a nut and fix it underneath with another nut (Figures 23).
  - At the top of the rod, screw the 12 mm clamp and in the clamp and place the motor inside (Figures 27).
  - Strengthen the clamp together with the motor with two screws
  - Weld the 2 cables that we had left prepared before to the 2 outputs of the motor (Figure 22).
  - Connect the positive pole of one cell to the negative pole of the next leaving at the ends of the 4 cells only one positive pole that we will weld to the cable that comes from the LED diodes and the negative pole that we will weld to the cable that comes from the switches (Figures 24).
  - Push the small joint into the pin of the motor. Knot the thread on with the piece at the end
  - Try out the switches one-by-one. Observe how many of them you can switch on (it depends on the light arriving on the PV cells) (Figures 25-26).
  - Try out the 3 stage switch. If it works well, in upper stage it turns to one direction, after leaving pushing it, it jumps back to the middle stage and in lower stage the motor turns the wings to the other direction (Figures 27-28).

- *Illustration for construction*



Figure 15

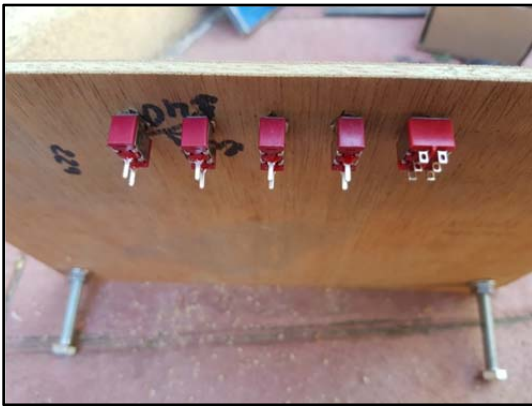

Figure 16





Figures 17



Figures 18

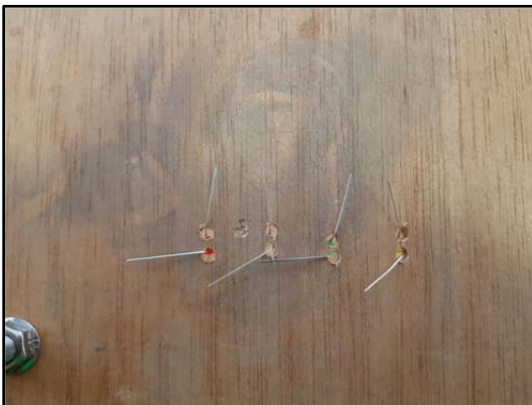

Figures 19

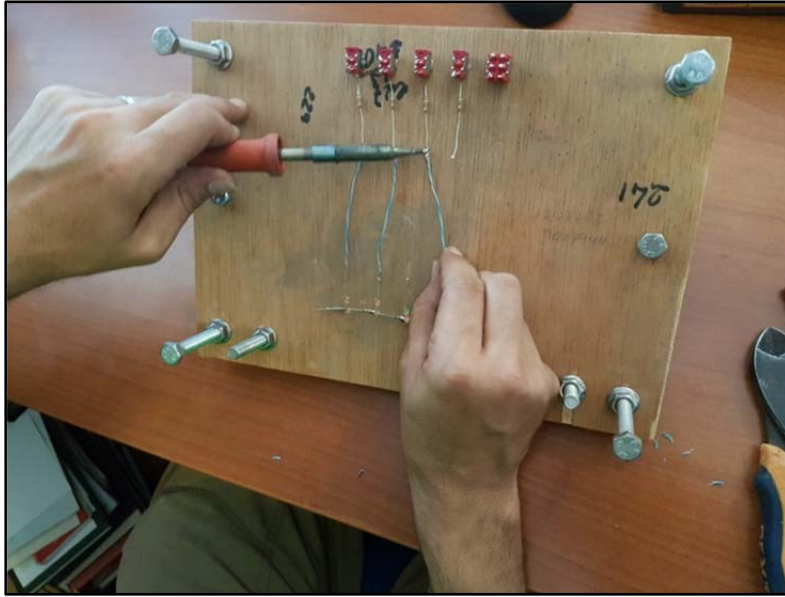
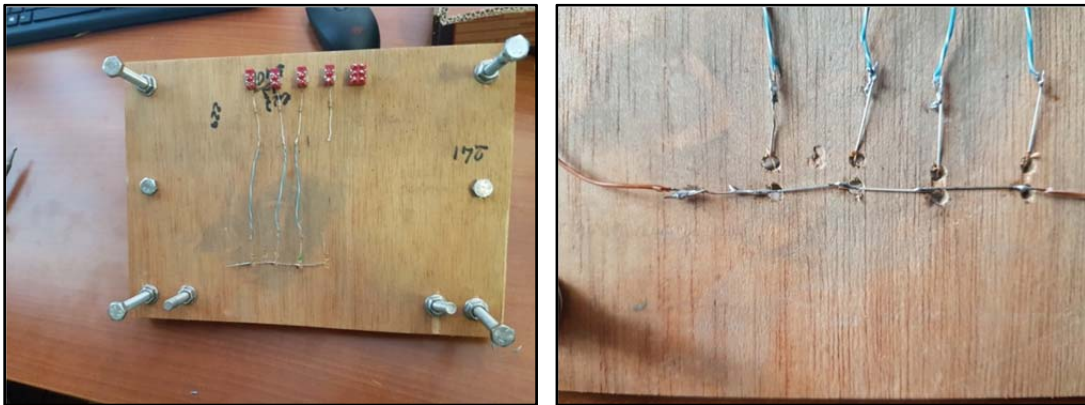

Figure 20



Figures 21

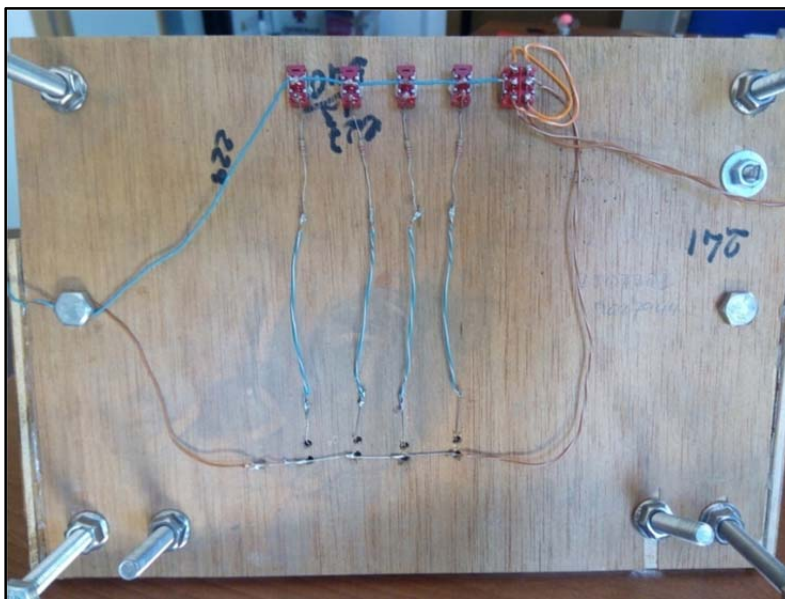
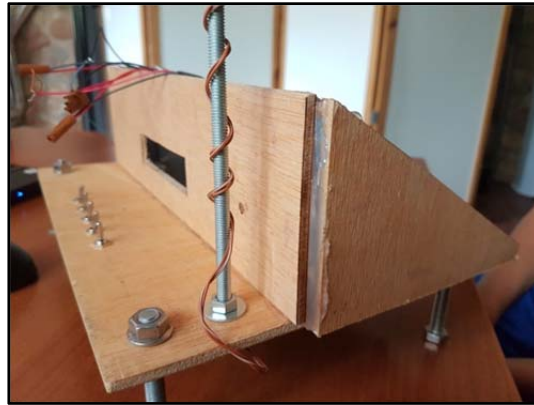
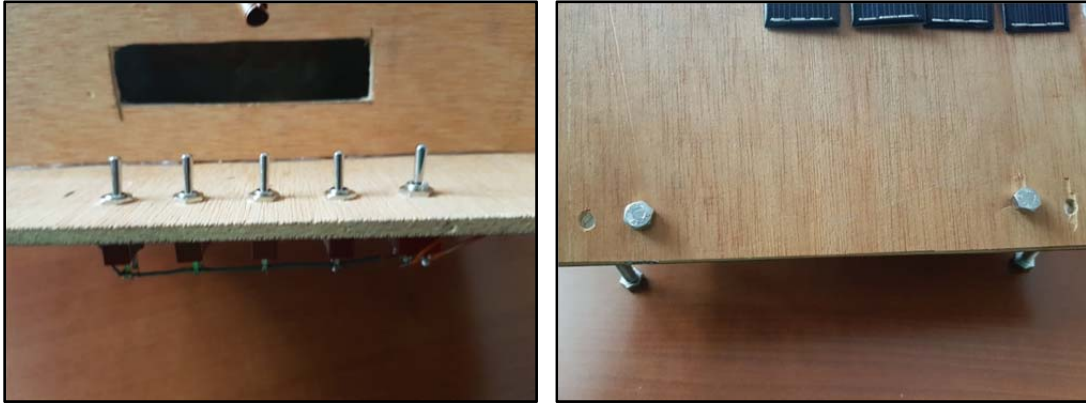
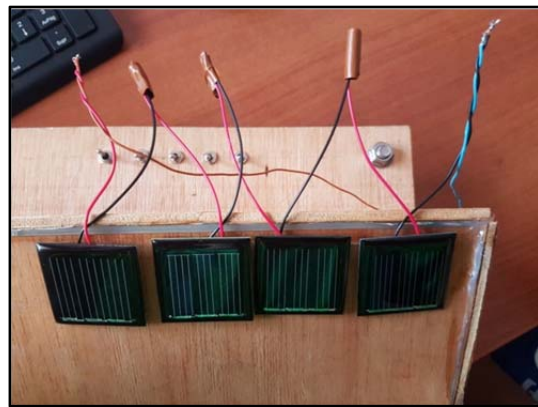

Figure 22



Figures 23



Figures 24



Figure 25



Figure 26

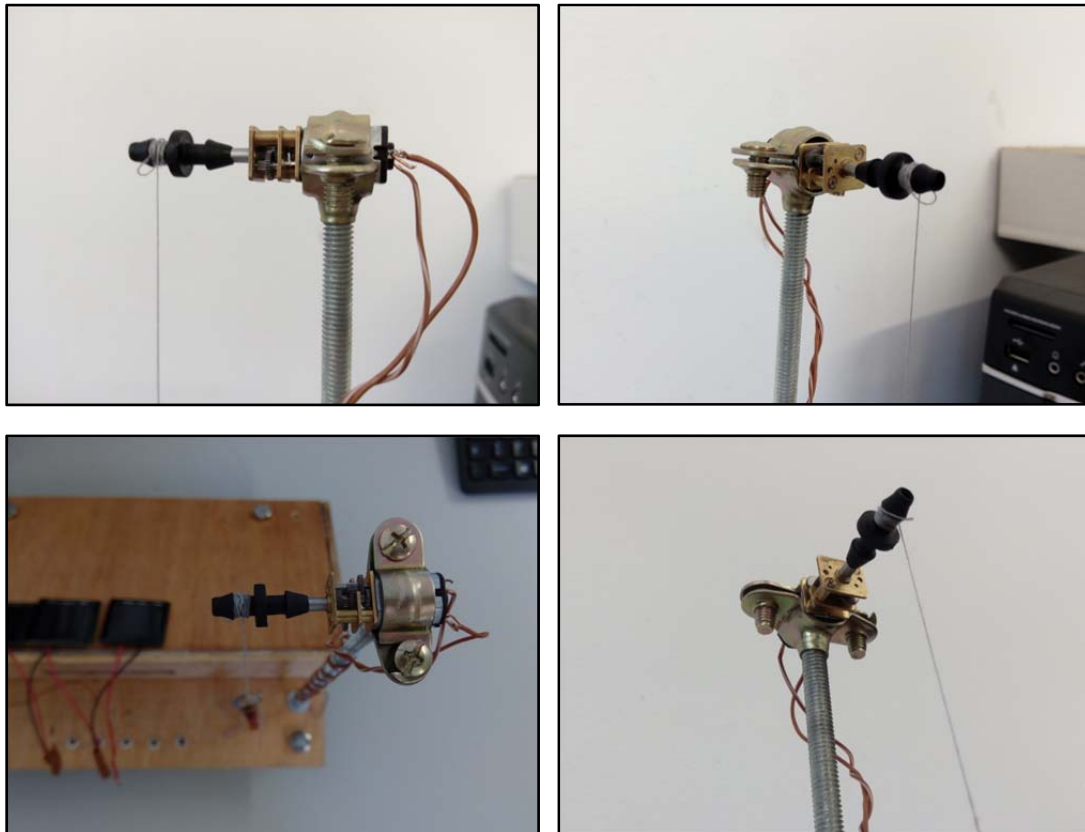

Figures 27

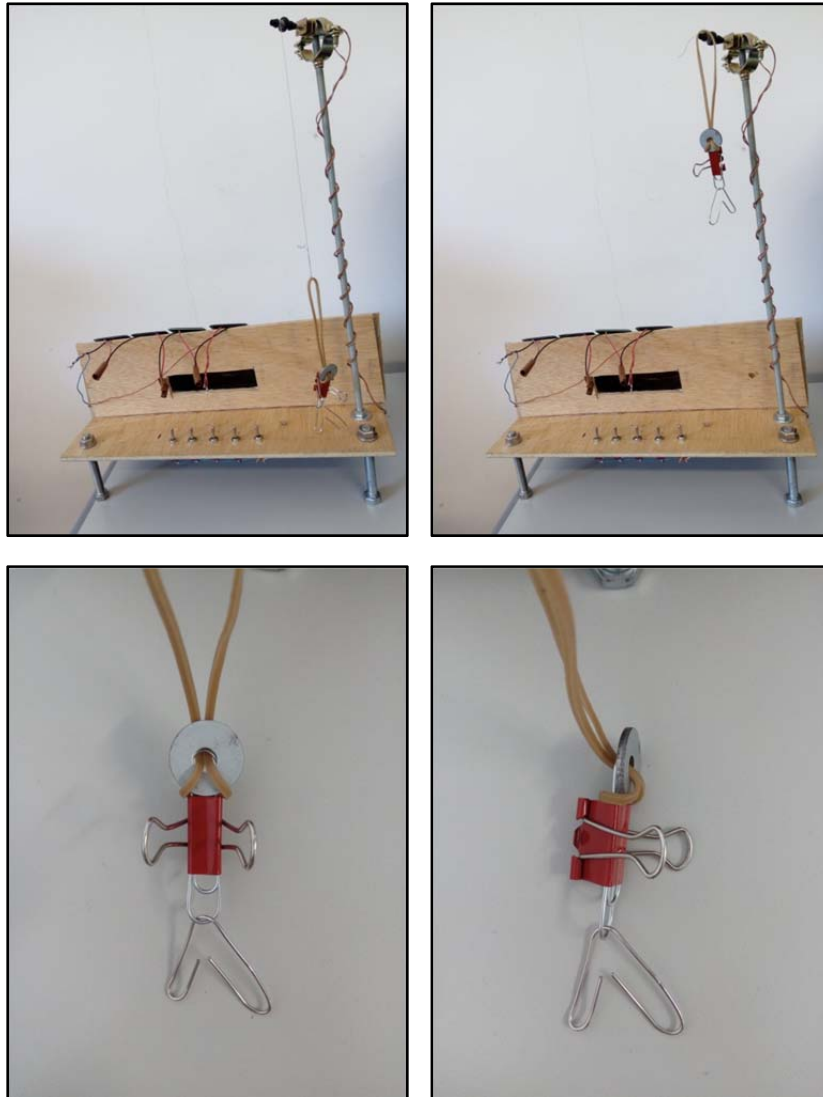

Figures 28

### 2.2.3. Aeroelevator

The workshop's goal is to experience the wind energy. As an output, a mock-up of a windmill (Figures 35) is going to be built. The turning axis is going to roll up the small piece to the "lookout".

- **Required tools**

- Cutter
- Scissor
- Drill

- **Required material**

Table 14. Required material for Aeroelevator

Required material	Suggested size	Pieces	Approximate price (for one unit)	Preferred characteristics	Where to get it from?
Plastic bottles	1.5 l 0.2 or 0.5 l	1 1	0 0		Household
Wooden sticks	minimum 5 cm longer than the height of the small bottle	1 piece	0 (1.2 € / package)	Or BBQ sticks	Household or supermarket
Paper		19x19 cm	0 (100 sheets / 2.7 €)	Decor or colored paper	Household or paper shop
Clip		1 piece	0 (0.25 € / box)		Household or paper shop
Stones		1 handful	0		Garden or park
Thread	30-40 cm	1	0 (1.5 € / spool of thread)		Household or haberdashery
Piece of LEGO	The lighter, the better is	1	0	Can be any kind of piece that is light	Household
Sellotape	3 cm	1	0 (0.65 € / roll)		Household or paper shop
Superglue		1	5 drops		Household or paper shop

- **Construction step-by-step**

- Prepare all the materials and the tools listed above (Figure 29)
- Cut the neck of the big bottle, it is going to be the foundation of the windmill

- Cut a sort of holder out of the top so that it can hold the smaller plastic bottle when it is laid horizontally by cutting off two "sides" and leaving two "sides" (Figure 30-31).
- Fill the stones into the bottom of the bottle, this will guarantee the stability of the tower (Figure 31).
- Drill two holes into the small bottle: once into the bottom, second into the bottle tap a slightly larger diameter than the wooden stick. It is important to let the stick turning, the small bottle stands still (Figure 32).
- Ply the wings of a classical windmill, pin it through with the stick
- Glue the wings together and to the stick the closest possible to the end of the stick (Figure 33)
- Pin the stick through the tap of the bottle and the small bottle
- Open the outer stem of the clip
- Fix the clip to the end of the stick with sellotape
- Stitch the thread through the clip and knot it tight
- Knot the piece to the end of the thread (Figure 34)
- Try it out: start to move the wings by hand, the thread should be rolled up on the clip and the piece should be lifted up (Figures 35)
- If it works fine, try it by blowing the wings and if there is windy enough outside, bring the windmill model outside and try how the wind energy is turning into mechanical energy

- *Illustration for construction*



Figure 29



Figure 30





Figure 31



Figure 32



Figure 33



Figure 34

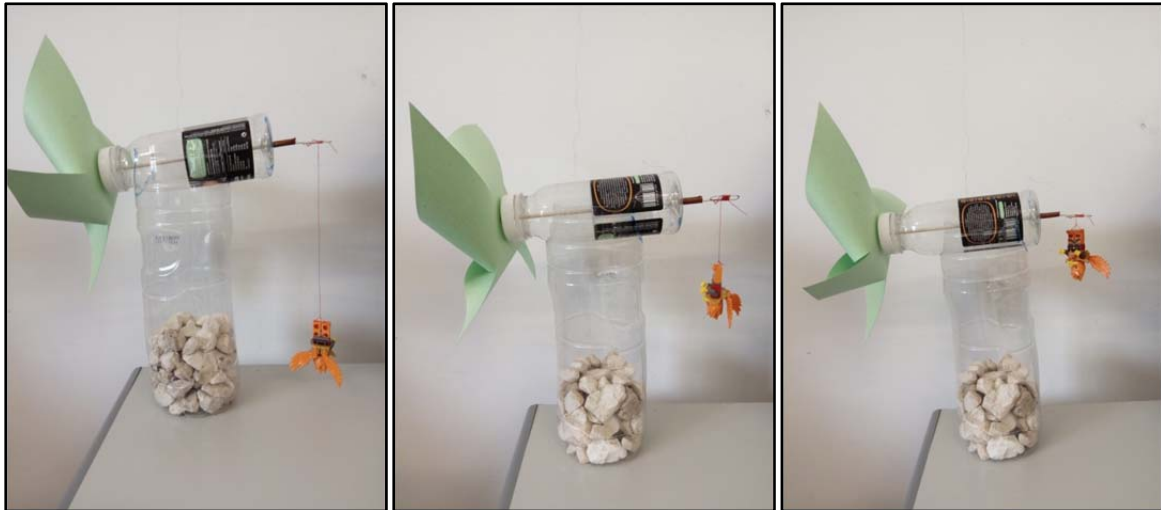

Figures 35



# Budget and economic analysis



### 3. Economical aspects of the project.

In this chapter a hypothetical business case is presented. The business is about renewable energy education in rural schools. The economical study contains the financial calculation, viability of such classes and applicable for an individual entrepreneur or also for an existing business that would like to enlarge its scope.

#### 3.0. Budget of the workshops

The concrete case starts with three topics (three different workshops) for schools in Castellón province, Spain. At the end of the present economical study three packages will be offered that vary in the cost, target age and all of them are in the topic of renewable energies.

The following table summarizes the costs of each workshop.

Table 15 – Price by workshop

EUR	Domestic Water Heater	Photovoltaic Energy in Domestic Lighting	Aeroelevator
personal	150	150	150
material	63	182	0*
travelling	46	46	46
indirect costs (20%)	52	76	39
benefit (15%)	39	57	29
<b>TOTAL</b>	<b>350</b>	<b>511</b>	<b>264</b>

In the three columns are represented the three topics of the different workshops.

The costs mean the followings one-by-one:

**Personal:** is the cost of one person who is preferably environmental educator, teacher or animator. The cost covers the class (preparation, travelling, the class itself and after work) and the administrative work (organizing the classes with schools). This person is self-employed or in cases of a functioning enterprise the person in charge of this task.

**Material:** Consists all the material that is listed in the 2.2 *Construction guide*. The prices in the Construction guide are calculated to build one mock-up, therefore this is the cost of one group. Here, the quantities are calculated for a class that supposedly consists of 30 students that are brought under five groups (six students in one group). It has to be mentioned, that however, the most economical materials were chosen, for schools with limited budget there is a possibility to decrease the price by forming bigger groups, thus needing less material. It is described in details in the next subchapter.

\*The material cost of the aerelevator is indicated as 0 EUR because it can be built from waste material and materials that normally can be found in a household or in an office. In case, the business is started from the very zero, with 6.3 EUR “investment” numerous workshops can be hold. For its simplicity it can be a popular way to start the renewable energy class series in the rural areas of Castellón.

**Travelling:** an average is calculated. It is supposed, that the business is located in Castellón city. The average distance (return trip) is 185 km to the following locations (Morella, Vistabella, Montanejos and Losilla). They were chosen as possible destinations of the workshops. The average travelling time is 3 hours. The trip is organised by car that let the teacher carry the materials needed for the workshops. The average consumption of the car is 0.25 EUR/km, that includes fuel and maintenance costs.

The above listed three cost types are the **direct costs**.

The **indirect costs** are the 20% of it that includes the marketing, phone and office costs (like stationery, electricity bills, etc.) and unexpected costs.

The **benefit** of the business is defined in 15% of the direct cost that is going to be invested back to the business (see 4.4 *Future plans*).

### 3.1.Price variations

In this subchapter a few opportunities are listed depending on the quantity of used material. However the suggested size of the group is 3-6 students, educators are free to establish bigger groups, thus making more economical the classes. It is considered as a good solution for schools with limited budget. For them, the table below shows the prices depending on the number of groups established in the class.

Table 16 – Price variations depending on number of groups (consequently group size)

EUR	Domestic Water Heater	Photovoltaic Energy in Domestic Lighting	Aerelevator
5 groups	349	511	265
4 groups	332	461	265
3 groups	316	412	265
2 groups	299	363	265
1 group	282	314	265

### 3.2.Payback, IRR and NPV

These terms are hard to be interpreted in the context of the present case study, based on many reasons, just to mention one, is that there aren’t important investments appearing in the business case. The most important things that are needed are the knowledge and experience in the field of environment, climate change and especially renewable energies, moreover

pedagogical background, experience in education and with students. To start the business, the main investment is time and energy, supposedly that the person lives in an average household, optionally has his or her office or works from home.

Assuming the above mentioned conditions, an approximate calculation is attached below, based on hypothetical numbers.

### 3.3. Time management

Regarding how much personal commitment is needed, one day per class can be calculated, as on average 3 hours are spent on travelling, 2 hours on preparation and the workshops last 2 hours as well on average. This all together takes one working day.

Organising the workshops one-by-one, communicating with schools and administration would use up half a day per each session on average (by starting the business more, later evidently less).

Supposing that there are 10 workshops a month, and calculating with 4 weeks monthly, it results 10 complete working days per month and ten times half days of administration and organization, that sums 15 days of work a month in total (out of 20 more or less) that can be considered 75% intensity in time.

It has to be mentioned, that if we calculate only with the 9 months school period, the rest 2 months of the year are considered as holidays over the regular (20 days=) 1 month holidays. Therefore there are 9 months out of 11 months which results 82% intensity in time. However these two months extra can be considered either an opportunity to develop further the business and investigate into new materials and methods, or hold summer camps, summer activities with the same materials, it stays optional.

Concluding all the above, 75% monthly intensity and 82% “yearly” intensity results 62% working intensity in time at the end of the year.

The business plan is sustainable in time, as in the next school year, the same workshops can be organised for the new classes in the same age range.

### 3.4. Salary calculations:

In internet databases 83 secondary schools can be found in the province of Castellón [11] and they have more classes in the school.

Putatively, not all of them will buy the most expensive package, but might do fewer groups in the class. The following table shows the calculations for the different packages and the possible number of clients. Due to the characteristics of the workshops, provisionally, the 50% will choose the Aeroelevator, 30% the Water heater system and 20% the Photovoltaic mock-up. The following table shows the calculated incomes depending on the number of groups.



Table 17 - Yearly income per workshop and number of groups

EUR	Domestic Water Heater		Photovoltaic Energy in Domestic Lighting			Aeroelevator			
	Price of ws.	Number of ws.	Price	Price of ws.	Number of ws.	Price	Price of ws.	Number of ws.	Price
5 groups	349	1	349	511	1	511	265	9	2.384
4 groups	332	2	665	461	2	923	265	9	2.384
3 groups	316	6	1.893	412	4	1.649	265	9	2.384
2 groups	299	10	2.987	363	6	2.179	265	9	2.384
1 group	282	8	2.255	314	5	1.570	265	9	2.384
<b>TOTAL</b>		<b>27</b>	<b>8.149</b>		<b>18</b>	<b>6.833</b>		<b>45</b>	<b>11.922</b>
							<b><u>Yearly</u></b>	<b><u>90</u></b>	<b><u>26.904</u></b>

In the next calculations you see summarized the incomes and expenses as per financial category.

Yearly costs	
personal	13.500
travelling	4.163
material	2.266
indirect costs	3.986
benefit	2.989
<b>TOTAL (€)</b>	<b>26.904</b>

### 3.5. Conclusions:

This business case is viable and profitable at least in two cases.

Once – as it has been mentioned already before – for an already existing company can be a new line of interest, with the dedication of one person as staff with 62% yearly intensity in time. This person would receive 1500 € salary during 9 months.

Second, for an individual entrepreneur, it is an opportunity for someone that cannot dedicate his or herself for a fulltime job – mothers with young children, university students or young people having temporary jobs for summer holidays (as occurs for example in tourism sector).

### 3.6. Future plans

However the business is feasible with these three workshops, depending on the motivation and vocation of the educator, also on the demand from customer side, more workshops can be



developed and organised in different environmental topics (water, waste, biomass, etc.). This, for example can be financed from the benefit line of incomes.

There is a possibility to enlarge the area of Castellon to the provinces of Valencia, Teruel y Tarragona. In this case we might consider longer trips and more budget for travels.

In case of growing workload, demand and income, it is an option to enlarge the staff and establish a private school that provides educational services for schools, private persons or municipalities or even other businesses. Later the school might offer services in other topics, like languages, after-school activities, summer camps or excursions.



**Compilation of case studies of applying renewable energies to local development transnationally implemented**



Co-funded by the  
Erasmus+ Programme  
of the European Union





# Project plans

#### 4 . Project Plans

This chapter consists of the supporting documents to the 2.2 *Construction guide*. In relation with (2.2.2) *Photovoltaic Energy in Domestic Lighting*, there are three construction schemes in order to understand better the necessary steps. Namely:

- General Layout of Photovoltaic Mock-up

That shows in details the whole “house” that is aimed to be built during the workshop.

- Basement layout of Photovoltaic Mock-up

That was designed especially to show with details where and how large holes are needed to be drilled on the basement.

- Electrical layout of Photovoltaic Mock-up

That serves to give guidance on the realization of the electric part of the mock-up.

- Solar cell technical information

That provides detailed technical description on the used solar cells.

- Motor technical information

That provides detailed technical description on the used motor.

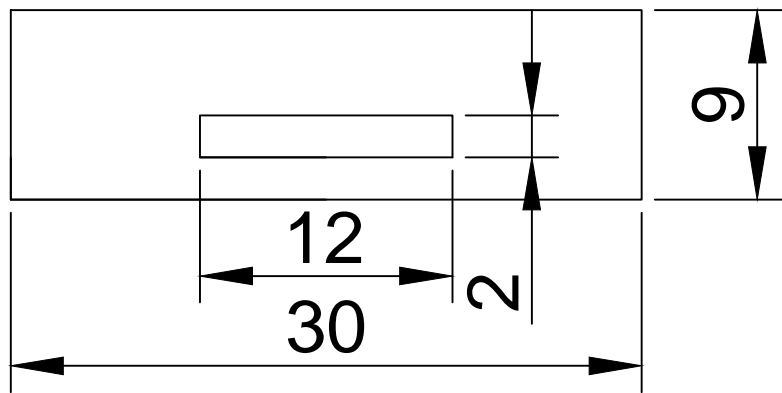
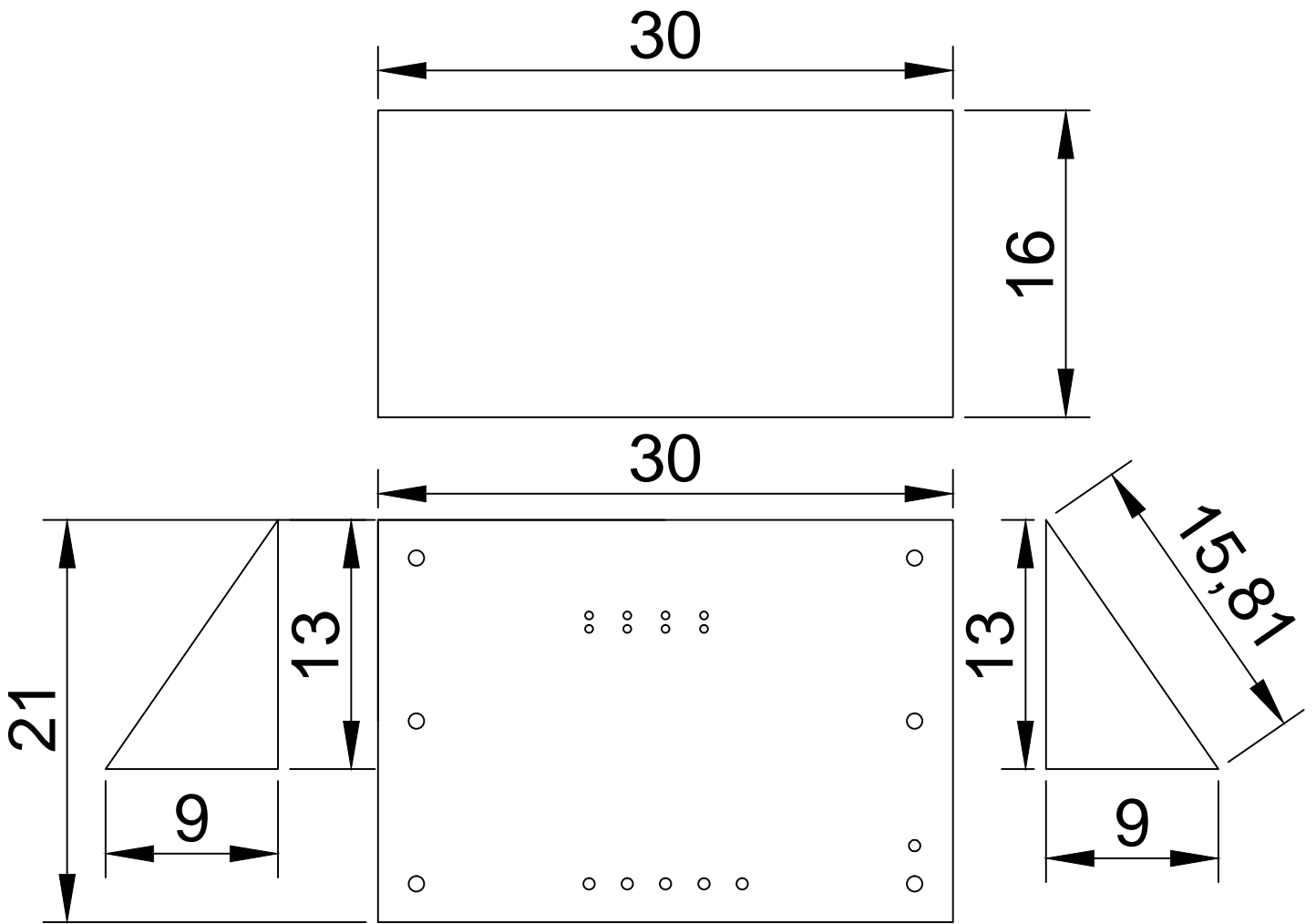

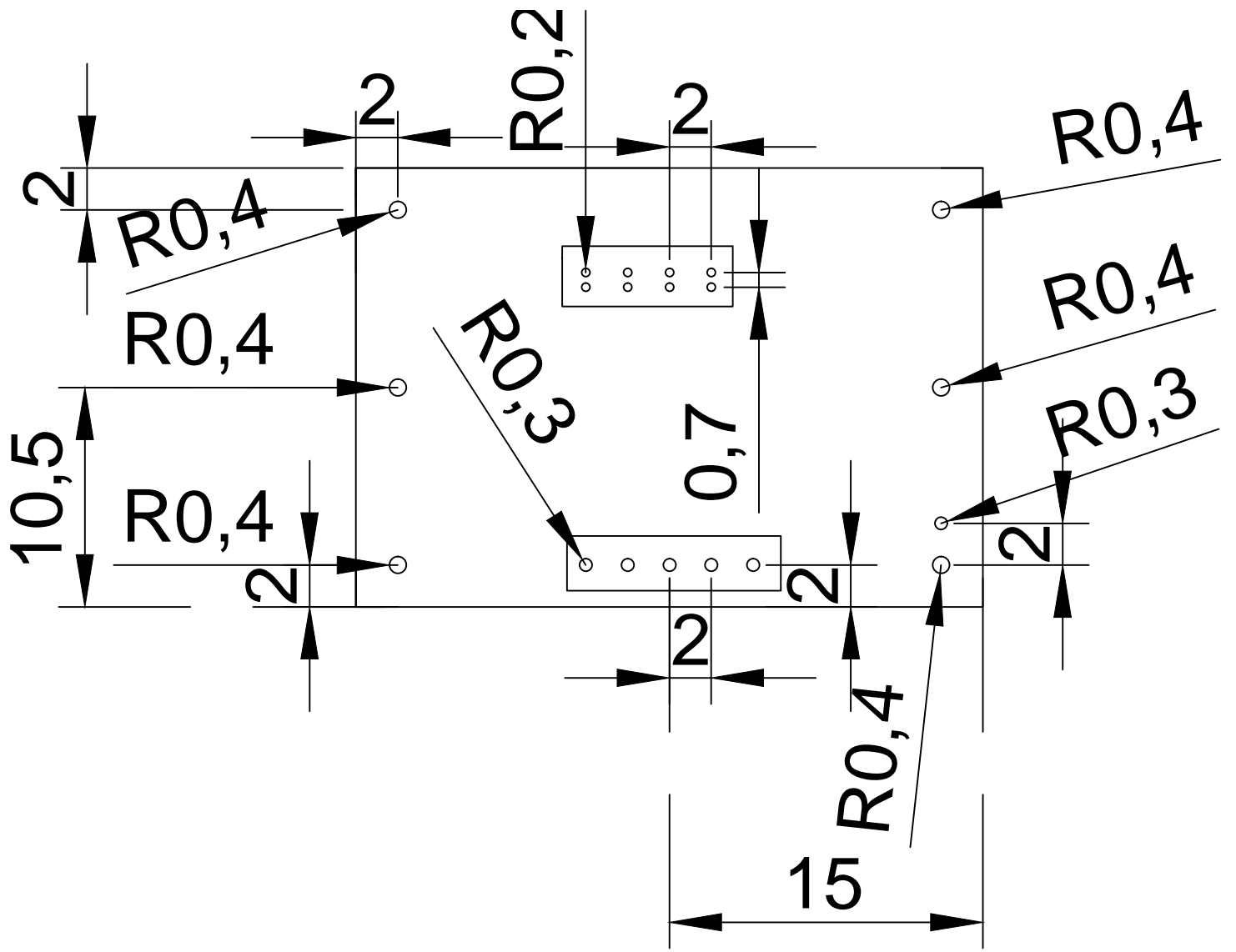

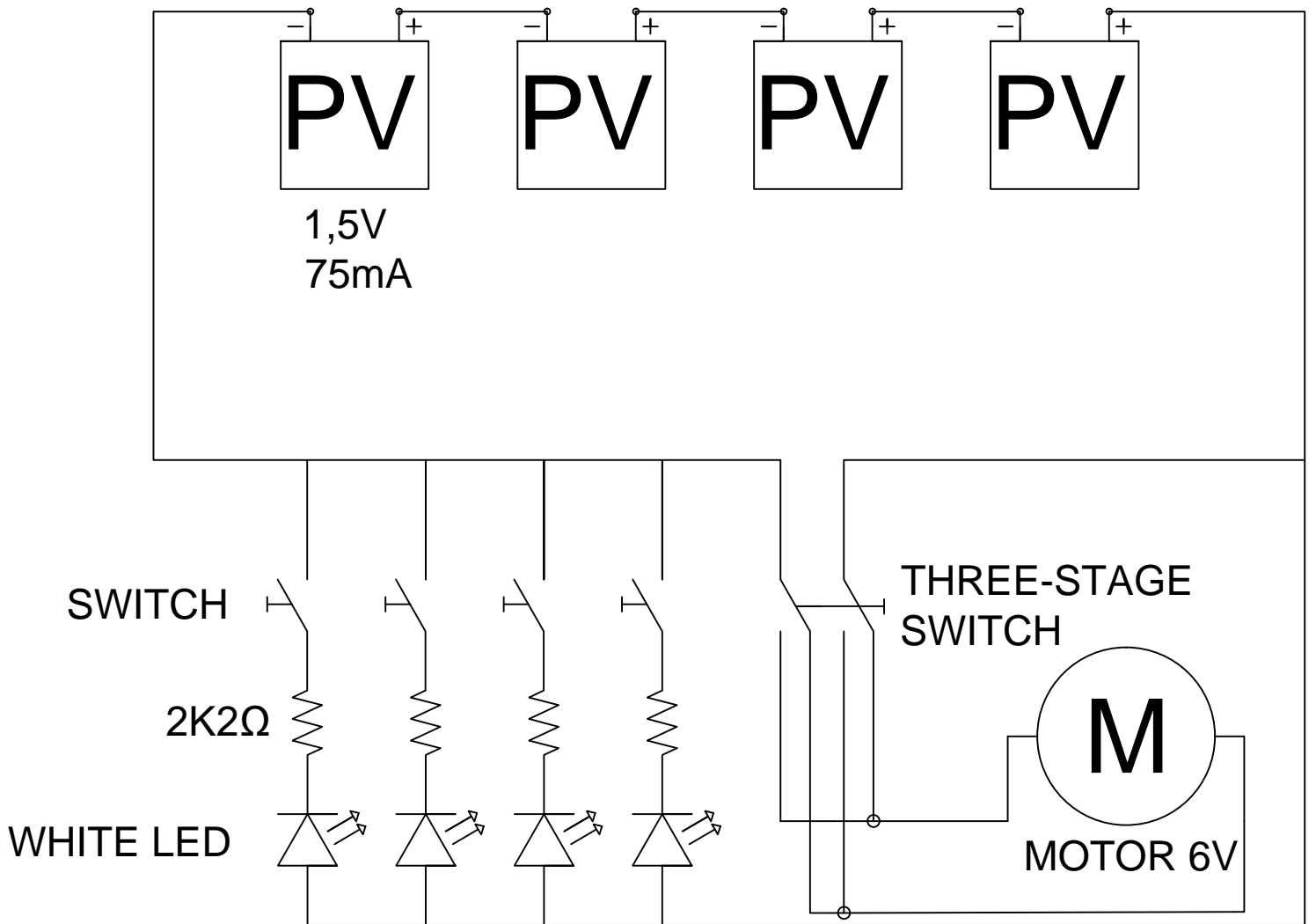



## SOLAR CELL PANNEAU SOLAIRE PANEL SOLAR 1.5 V 110 mW C-0137

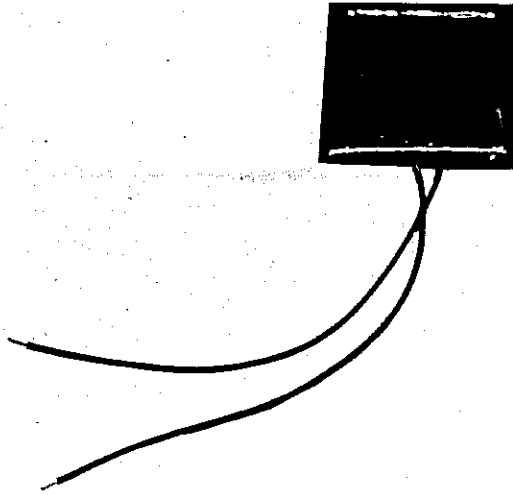

### TECHNICAL CHARACTERISTICS

Power.....	110 mW
Voltage Voc.....	1,5 V. DC
Isc.....	75 mA.
Vm.....	1,0 V.
Im.....	56 mA.
Measures.....	40 x 40 mm
Connection.....	AWG26 13 cm.
Lot.....	4 units

Photovoltaic solar cells and high-performance miniaturized. They are ideal for classroom practices of technology, electricity, electronics, crafts, and robotics for any type of installation that requires a very small cell size and high performance. See our catalog the various special solar engine can be driven directly by these cells .

Mounting and installation. For cell fixation is recommended to use double sided tape on the back. Preferably a spongy base tape. The cell should stand we face the direct sunlight. Its performance depends on the light received. It can run on the inside, if the cell is illuminated with an incandescent lamp, preferably halogen. Not suitable for fluorescent lighting or compact fluorescent lamps .

Connection. Photovoltaic cells can be grouped into assemblies "series", "Parallel" and "mixed." When connecting two or more identical cells in series, the resulting voltage is the sum of all of them and the current intensity is the same for all. When connecting two or more identical cells in parallel, the voltage will be the same for all, with the resulting current intensity equal to the sum of all intensities. With serial, parallel or mixed is possible to obtain voltage and current we require. It is very important to respect the polarity shown in the diagrams .

Les panneaux solaires photovoltaïques de haute performance miniaturisés. Elles sont idéales pour les pratiques en classe de technologie, de l'électricité, l'électronique, de l'artisanat, la robotique et de montage pour tout type de cellule nécessaire par une très petite taille et haute performance. Voir nos spéciaux moteurs solaires en notre catalogue qui peuvent être entraîné directement par ces panneaux solaires.

Pour fixer le panneau recommandé d'utiliser un adhésif double face sur le dos. De préférence, une bande de base spongieux. Le panneau doit être placé adressée directement au soleil. Sa performance dépend de l'éclairement reçu. Vous pouvez travailler à l'intérieur, si le panneau les lumières une lampe à incandescence, halogènes de préférence. Ne convient pas pour l'éclairage fluorescent ou des lampes fluorescentes compactes.

Les panneaux photovoltaïques peuvent être regroupés en ensembles "de série", "parallèle" et "mixtes". Connexion de deux ou plusieurs panneaux, en nombre égal, la tension qui en résulte est la somme de tous et l'intensité du courant est la même pour tous. Connexion de deux ou plusieurs panneaux en parallèle égale, la tension sera la même pour tous, avec l'intensité de courant résultant égale à la somme de toutes les intensités. Avec série, parallèle ou mixte est possible d'obtenir la tension et le courant nous avons besoin. Il est très important de respecter la polarité indiquée dans les diagrammes .

Células solares fotovoltaicas miniaturizadas y de alto rendimiento. Son ideales para prácticas en el aula de tecnología, electricidad, electrónica, manualidades, robótica y para cualquier tipo de montaje que precise una célula de tamaño muy reducido y altas prestaciones.

Consulte en nuestro catálogo los diversos motores solares especiales que pueden ser accionados directamente por estas células. Montaje e instalación. Para la fijación de la célula se recomienda usar cinta adhesiva de doble cara en el dorso. Preferiblemente una cinta con base esponjosa.

La célula debe situarse encarada a los rayos solares directos. Su rendimiento depende de la iluminación recibida.

Puede funcionar en el interior, si se ilumina la célula con una lámpara de incandescencia, preferiblemente halógena. No es adecuada para iluminación de tubos fluorescentes o lámparas fluorescentes compactas.

Conexión. Las células fotovoltaicas pueden agruparse en montajes "serie", "Paralelo" y "mixto".

Al conectar dos o más células iguales en serie, la tensión resultante será la suma de todas ellas y la intensidad de la corriente será la misma para todas.

Al conectar dos o más células iguales en paralelo, la tensión será la misma para todas, siendo la intensidad de la corriente resultante igual a la suma de todas las intensidades.

Mediante conexiones serie, paralelo o mixtas es posible obtener la tensión y corriente que precisemos.

Es muy importante respetar la polaridad que se indica en los esquemas.

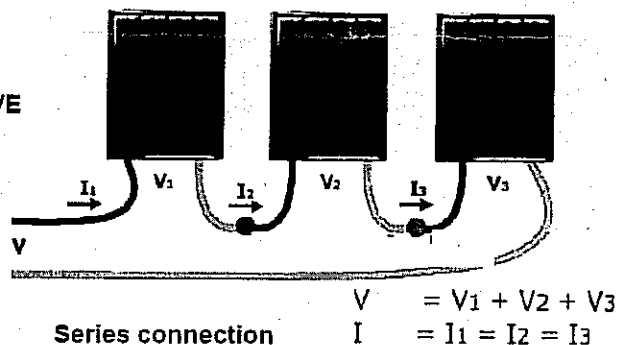
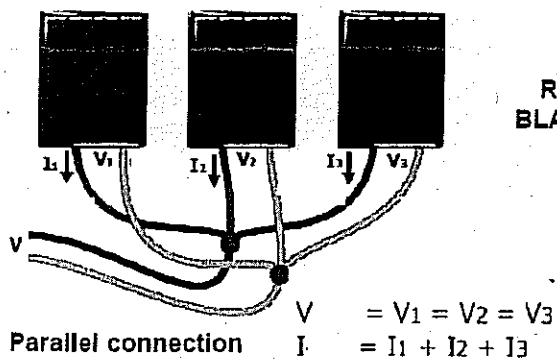

Cebekit <sup>®</sup> is a registered trademark of the Fadisel group



# Sourcingmap

## A12081300UX0999 - Motor micro DC

de Sourcingmap

4.5 de un máximo de 5 estrellas 2 opiniones de clientes

Precio: EUR 12,18

Elige envíos **GRATIS** más rápidos con [Amazon Prime](#) o elige envío **GRATIS** en 4-5 días en pedidos superiores a 29€

Precio final del producto

Vendido y enviado por Amazon. Se puede envolver para regalo.

- Nombre del producto: Motor Micro DC; Modelo n°: GB380-07285; Voltaje: DC 6V
- Corriente (sin carga): 1.3A; Velocidad (sin carga): 30RPM; Esfuerzo de torsión: 2.5g.cm
- Tamaño cuerpo: 12 x 15mm / Diámetro eje: 3mm/ Longitud total: 35mm
- Color principal: Plateado; Material: Metal
- Peso: 11g; Paquete: 1 x DC Micro Motor

### Información de producto

#### Detalles técnicos

Identificador de producto del fabricante	a12081300ux0999
Peso del producto	9 g
Dimensiones del producto	3,5 x 1,2 x 1,5 cm
Número de modelo del producto	a12081300ux0999
Número de productos	1
Número de piezas	1
Número de empuñaduras	1
Sistema de medida	Metric
Componentes incluidos	1 x DC Micro Motor
Incluye baterías	No
Necesita baterías	No
Peso	9.1 gramos





**Compilation of case studies of applying renewable energies to local  
development transnationally implemented**



Co-funded by the  
Erasmus+ Programme  
of the European Union

REPORT OF THE CASE STUDY ON RENEWABLE ENERGIES TO LOCAL  
DEVELOPMENT TRANSNATIONALLY IMPLEMENTED

# Agricultural biomass production for bioenergy in integrated RE systems of small agricultural enterprises

Mouhanna Atena Georgiana  
"Vasile Alecsandri" University of Bacau  
[atnageorgiana@gmail.com](mailto:atnageorgiana@gmail.com)

Case study tutor: Csaba Szűcs  
Renewable energies tutor: Csaba Patkos - GEOLIN  
Rural development tutor: Vicent Querol  
English tutor: Csaba Szűcs  
Professional supervisor: Sandor Nemethy/ Csaba Patkos  
March-April 2017



**Compilation of case studies of applying renewable energies to local  
development transnationally implemented**



Co-funded by the  
Erasmus+ Programme  
of the European Union





## Contents of the project

1. Memory of the project - Introduction .....	8
1.1. Fossil fuel vs renewable energy	10
1.2. Objective of the project	11
1.3. Location of the project	12
1.4. Precedents	14
1.5. State-of-art in the problem domain	24
1.6. Sources of biomass	28
1.7. Design of biomass heating system	28
1.8. Impact of the project for the rural development	29
1.8.1. Environmental impact	31
1.8.2. Social and rural impact	33
1.9. Conclusions	35
1.10. References	
2. Calculations and design .....	40
2.1. Energy demand, system losses and performance rate	40
2.2. Installation sizing and selection of the equipment	44
3. Economical aspects of the project.....	55
3.1. Budget of the installation	56
3.2. PAYBACK, IRR AND NPV	59
4. Project plans.....	64





**Compilation of case studies of applying renewable energies to local  
development transnationally implemented**



Co-funded by the  
Erasmus+ Programme  
of the European Union





# Memory of the project



**Compilation of case studies of applying renewable energies to local  
development transnationally implemented**



Co-funded by the  
Erasmus+ Programme  
of the European Union



## 1. Introduction

Humanity today is massively dependent on Energy. Imagine a day without any energy supply; the poor will be poorer and the rich would hit rock bottom in just one day. Humanity as we know it cannot produce or carry out its everyday activities without energy. The major source of energy that the population is highly dependent on is fossil fuels, mainly oil followed by natural gas and coal. Fossil fuels make modern life possible, they work to generate power transportation systems, electricity and steam, making the production of tens of thousands of commercial goods possible.

Fossil Fuels are easily transformed into energy at a low-cost which makes all countries contribute to the use of those fuels as their main source of energy. Although fossil fuels are somehow easily extracted in some regions around the globe and easily transformed into energy that fulfills our current energy supply needs, a lot of problematic questions arise; for how long are we going to benefit from these energy sources before them drying out?

Fossil Fuels are limited and non-renewable and soon will be depleted as the rate of energy demand will increase in the near future.

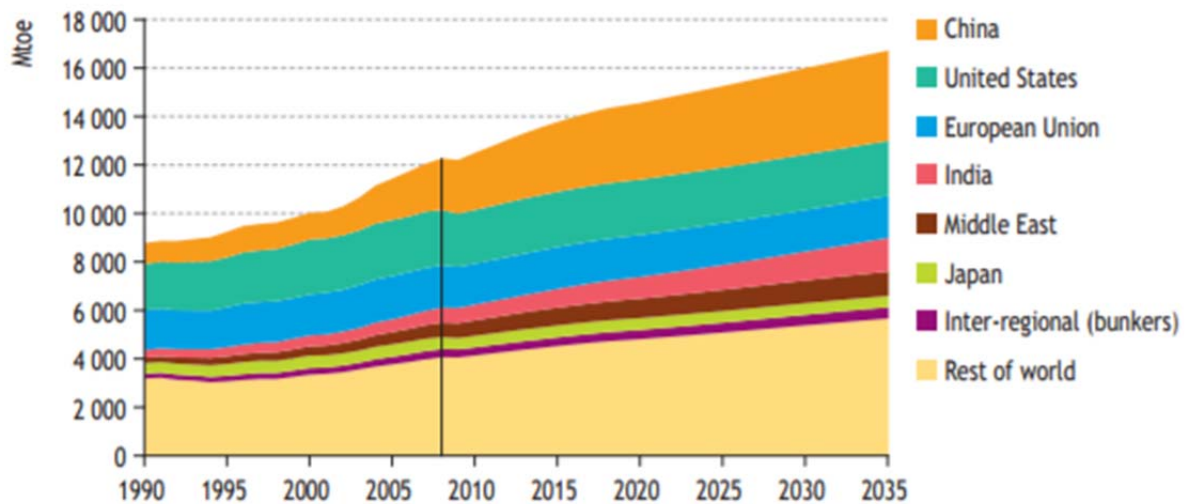

Figure 1. World Energy Demand [1]

(Source: IEA World Energy Outlook 2010)

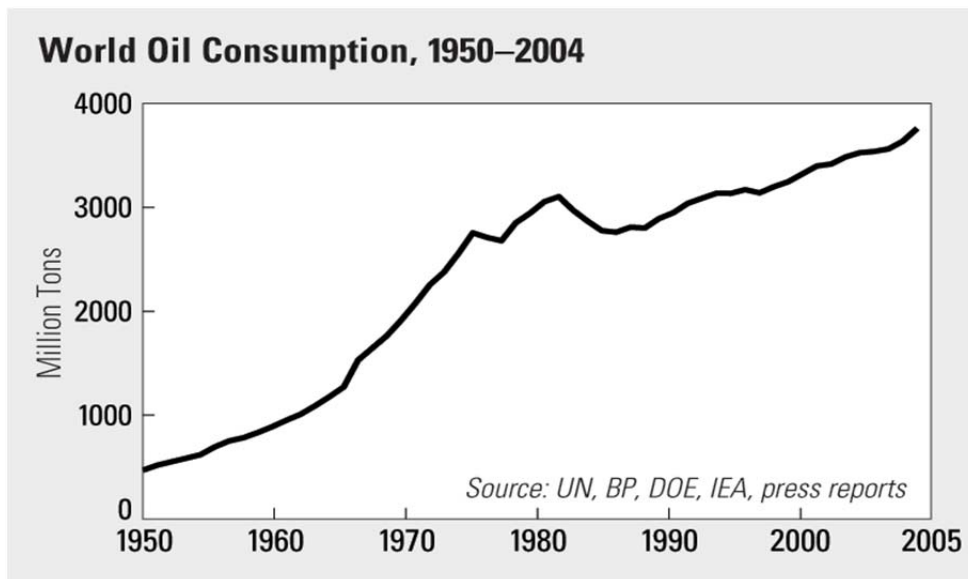

Figure 2. World Oil Consumption [2]

(Source: [http://www.worldwatch.org/brain/images/press/news/vs05-world\\_oil.jpg](http://www.worldwatch.org/brain/images/press/news/vs05-world_oil.jpg) )

According to IEA World Energy Outlook, the world’s main energy supply has boosted up by 58% in 25 years, from about 7.2 billion TOE in 1980 hitting the value of 11.4 billion TOE in 2005.

Experts foresee an increase in the energy demand proportional to the increase of economic growth of emerging market countries such as China, India, and the Middle East. The increase is estimated to be about 48% over the next 25 years, reaching 17.0 billion TOE in 2030.

Table 1. Energy Outlook

Items	Energy Demand M <sub>(toe)</sub>				
	1980	2000	2005	2015	2030
Total primary energy demand	7,223	10,034	11,429	14,121	17,014
Petroleum Oil	3,107	3,649	4,000	4,525	5,109
Transport	1,245	1,936	2,011	2,637	3,171
Petroleum	1,187	1,844	1,895	2,450	2,915
Biofuels	2	10	19	74	118
Other fuels	57	82	96	113	137

(Source: IEA Energy Outlook 2007,2008) [3]

### 1.1. Fossil Fuel vs. Renewable Energy

Fossil energy sources include oil, gas, and coal. They are non-renewable finite resources. The result product of millions of years of decayed prehistoric plants and animals that got gradually buried by layers of rock is what we call now fossil fuels. The type of fossil fuels depends on the nature of microorganisms, plants and animals (organic matter) that was present, for how long it was buried, temperature and pressure conditions along the years. These resources are collected by drilling and mining. Fossil Fuels are burnt to obtain electric energy and refined for heating and transportation fuel. [4]

Advantages of fossil fuels are:

- a. Fossil fuels were used to power our world for decades therefore, the technology used to harness that energy is well-developed;
- b. Fossil fuels are reliable sources of energy and are cheap too. They fulfill all our energy needs for a vast range of activities.

Those advantages might sound good enough, but the disadvantages of fossil fuel consumption are alarming:

- a. Fossil fuels are not green sources of energy. They contribute highly to Global Warming because they contain high levels of carbon and when burnt, they increase the levels of greenhouse gases in our Earth's atmosphere.
- b. It takes millions of years under favorable conditions for fossil fuels to regenerate in nonaerobic processes, which is why they are considered to be non-renewable sources of energy. Even though fossil fuel reserves around the globe might be considerable, humanity has been depending on these fuels to give an initial push into a technologically brighter future, which means that those energy sources, which are not replenishing will dry out sooner or later.

oil	between 2010-2020
coal	100 to 150 years from now
natural gas	from 120 to 150 years from now
<sup>235</sup> uranium	100 to 120 years from now
<sup>238</sup> uranium	10,000 to 60,000 years

Table 2. Traditional fossil fuel yield peaks are not distant [5]

(Source: International Atomic Energy Agency)

- c. Fossil fuels are characterized by unsustainability which made people think about finding alternative sources to power our world’s engines. Those alternative sources would be renewable and eco-friendly energies.
- d. Many accidents could occur while these fuels are transported being highly flammable. Accidents in this case are not as serious as those related to nuclear power, but while transported – if accidents occur- they can produce spills that have been polluting our oceans and seas for the past century. [6]

Analyzing those disadvantages and noticing their obvious impacts on earth’s vital signs, the world’s interest for new sources of energy that cause less harm has awakened leading to the usage of renewable energies.

Renewable energies are sources of power that can never dry out and are abundant around the globe. They are easily replenished at a faster rate than that of their consumption. Using renewable energies serves to reduce the greenhouse gas emissions thus putting limits to the aggravating situation of global warming that we are currently facing.

These green energies come from diverse sources and have the potential to considerably reduce humanity’s tremendous dependency on fossil fuels, and they can also stimulate employment through creating new job offers in new eco-friendly and green technologies.

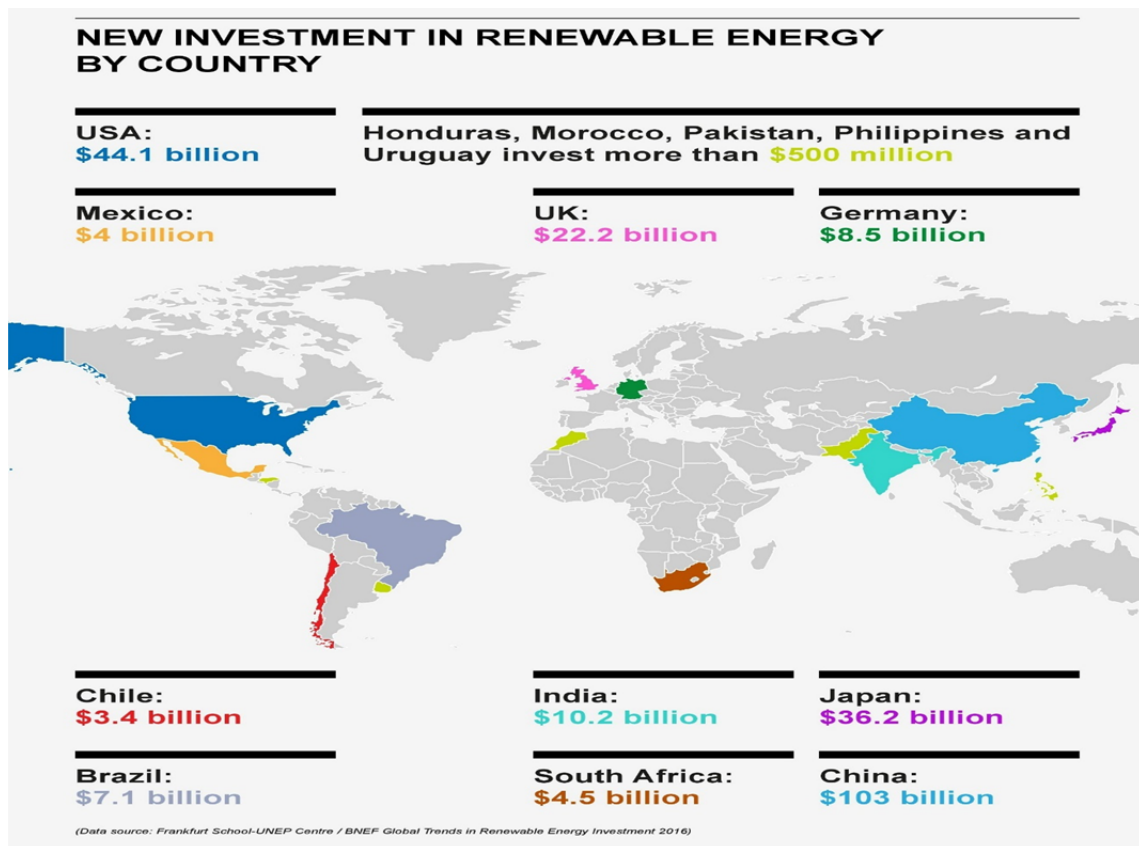

Figure 3. New Investment in Renewable Energy by Country [7]

(Source: <https://www.weforum.org/agenda/2016/04/4-charts-that-show-the-rise-of-renewables/> )

As we can see, countries worldwide have been largely investing in renewable energies in all forms. Moreover, we observe that the underdeveloped countries (e.g. India, South Africa, Chile, Honduras, Pakistan, Philippines) have been investing in green energies in a more evident matter than the developed countries (e.g. USA, and European Countries).

Renewable energies come in diverse forms but almost all of them depend partially or completely on sunlight. Wind and hydroelectric power depend in a complete matter on the differential heating of Earth's surface which leads to air moving creating what we call wind and the creation of precipitation as air is lifted, and that of course is thanks to sunlight. While wind and hydroelectric power are somehow created by sunlight, biomass is the stored solar energy in plants.

There are energy sources independent of solar energy, they are geothermal and tidal energies. [8]

## 1.2. Objective of the project

The main objective is the reduction of greenhouse gas emission through the introduction of innovative elements in the biomass processing and heat production.

- To replace the electric generator system already integrated for the greenhouse due to its low efficiency levels thus introducing a modern green wood-chip based heating system which is the boiler.
- Taking advantage of the availability of cost efficient wood and energy crops to be used as a renewable resource to power the boiler heating system.
- Taking into consideration multiple factors (moisture, wood quality, energy loss, pollution, labor cost, management and maintenance, transportation and harvesting fees, etc.)
- Encouraging the use of green energy systems in rural areas.
- Creating sustainability.
- Creating new job opportunities for locals in this rural area.
- Encouraging agriculture and paprika cultivation.



Global New Investment in Renewable Energy by Technology, Developed and Developing Countries, 2015

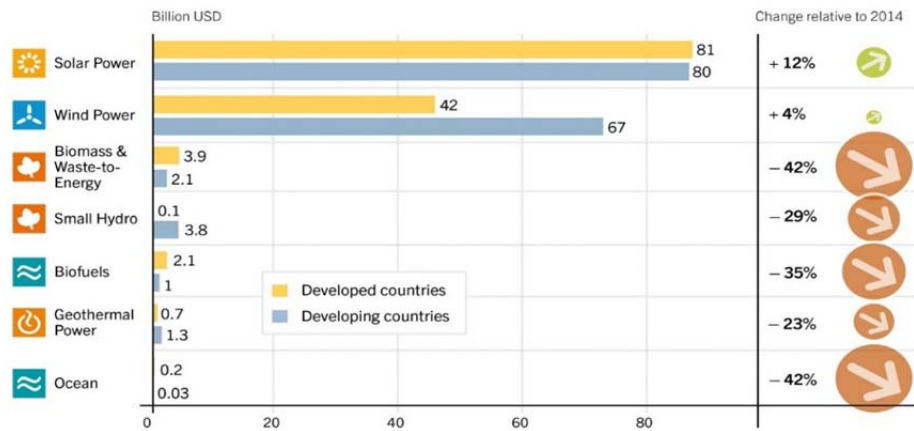

REN21 *Renewables 2016 Global Status Report*



Source: BNEF

Fig. 4. Employment in RE [9]

(Source:

[http://www.se4all.org/sites/default/files/IRENA\\_RE\\_Jobs\\_Annual\\_Review\\_2016.pdf](http://www.se4all.org/sites/default/files/IRENA_RE_Jobs_Annual_Review_2016.pdf))

### 1.3. Location of the project

The project is located in Tass-pusztá, Hungary.

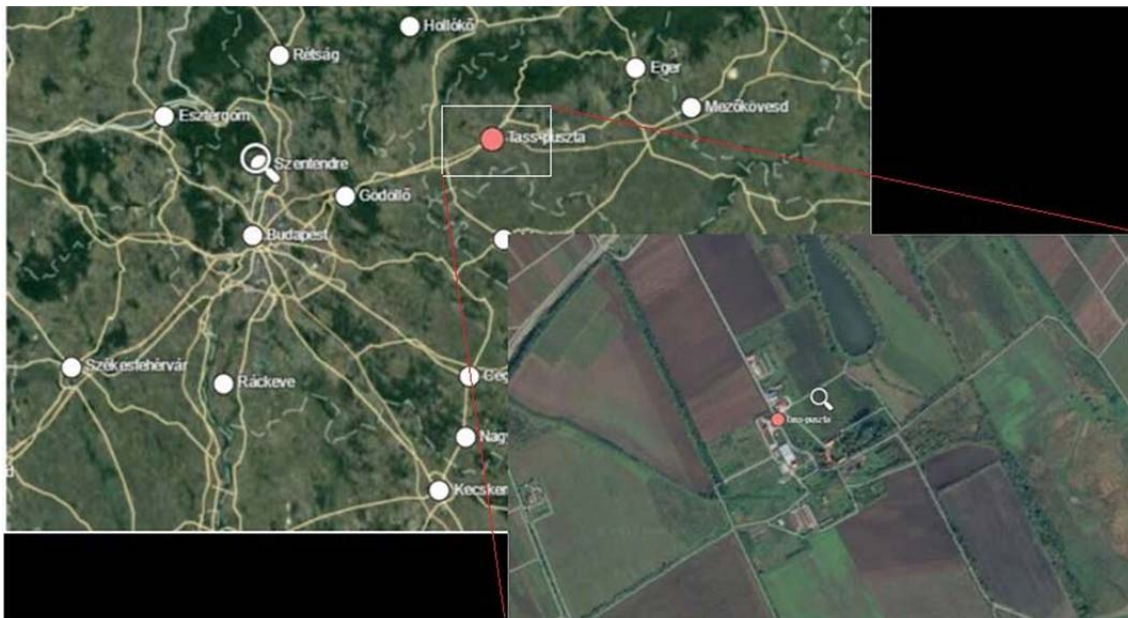

Fig. 5. Tass-pusztá location [10]

(Source: <https://mapcarta.com/18433856>)

**Location:** Hungary, Central Europe, Europe

**Latitude:** 47° 44' 5.3" (47.7348°) north

**Longitude:** 19° 52' 40.4" (19.8779°) east

**Elevation:** 124 metres (407 feet)

Tazz Puzta is an experimental farm belonging to Karoly Robert University. It's main research center is Kompolt center where all the researches are made. Tazz Puszta Farm is basically made of two essential parts:

- The paprika greenhouse that produces approximately 3 tons of ready to sell paprika each year. The greenhouse is the ideal place for paprika to grow and be harvested because paprika can on grow in an average temperature of 25 degrees Celsius.
- The heating plant where an electric generator provides the necessary energy for the heating of the paprika greenhouse.

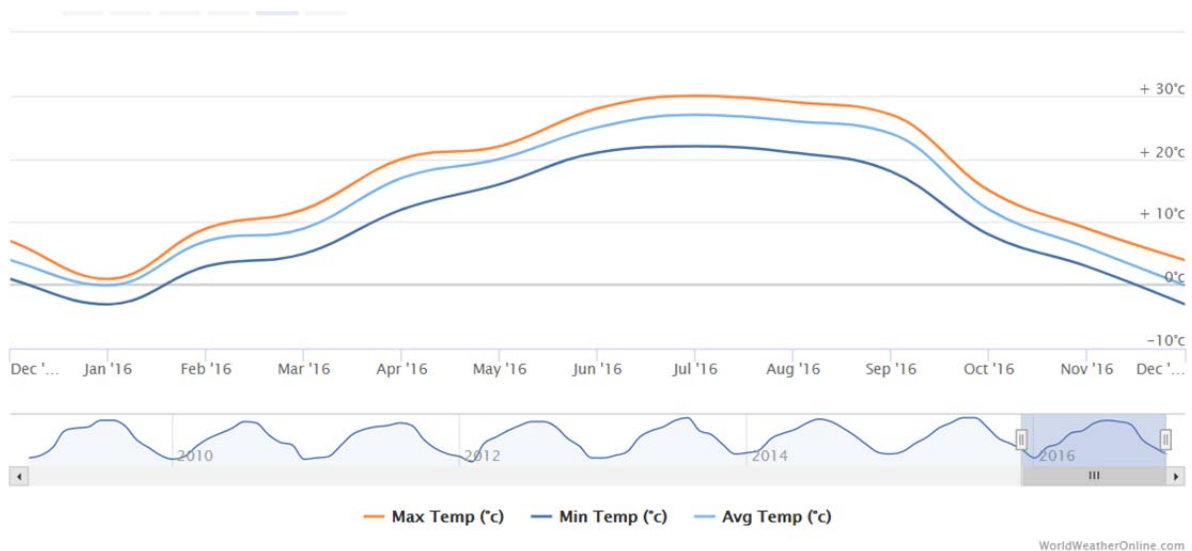

Fig. 6. Average temperature in Tass-puszta, Hungary. [11]

(Source: [https://www.worldweatheronline.com/v2/weather-averages.aspx?locid=971022&root\\_id=954533&wc=local\\_weather&map=~/tas-puszta-weather-averages/heves/hu.aspx](https://www.worldweatheronline.com/v2/weather-averages.aspx?locid=971022&root_id=954533&wc=local_weather&map=~/tas-puszta-weather-averages/heves/hu.aspx) )

## 1.4. Precedents

Biomass based boilers are used to provide heating for several facilities:

- Schools
- Hospitals
- Public buildings
- Hotels
- Commercial buildings
- Greenhouses
- Large-scale agricultural operations
- Manufacturing plants

Most biomass energy plants utilize some kind of wood to address their facilities' needs for space heating or local boiling hot water.

Biomass systems are often capable of giving higher levels of comfort at a lower energy cost. Because biomass fuels are very inexpensive, many building owners can afford comfortable temperatures for various uses especially in winter.

Biomass systems are relatively easy to convert into other types of fuel and offer high flexibility for a green energy future.

Therefore, all these make good enough reasons to replace the old heating system present in Tass-puszta study farm with a modern biomass-based boiler.

## 1.5. State-of-art in the problem domain

### Biomass

Photosynthesis is the process in which plants store solar energy to produce an organic material called starch. This captured energy that plants store is what we now call biomass. Biomass is used widely to produce electricity and heating. It is obtained from plants, animal wastes and other organic materials. It is a renewable and sustainable source of energy because it is a totally natural resource and is abundantly found and replenished. Types of biomass can be summed up in 5 main categories: Wood, garbage, crops, landfill gas and alcohol fuel.

The only way to release its energy, biomass is burnt. The energy release is in the form of heat energy. But biomass can also be converted in biofuels and biogases through multiple processes like fermentation. Those converted products can thus be burnt to produce electric and heat energy. For example, obtained methane gas is obtained from the decomposition of agricultural wastes and garbage in landfills in special containers called digesters and can be used to produce electricity, heating or power garbage trucks. Other examples are biofuels and ethanol that are obtained from sugar canes, vegetable oil and animal fats, and their main usage is to power vehicles.



Fig.7. Biomass Energy [12]

(Source: <http://www.nationalgeographic.org/encyclopedia/biomass-energy/>)

Bioenergy is basically the energy derived from converting biomass which can be used directly as a fuel by burning it, or converting this biomass into biofuel and biogas.

Nowadays, the most challenging requirement for humankind is finding a reliable and most importantly sustainable source of energy to address climate change and global warming. Currently, biomass is the largest global contributor of renewable energy and has the potential to significantly meet our needs of energy in the near and far future.

If managed in the proper ways, biomass can present the following advantages:

- Larger contribution to the total energy production around the globe;
- Economic and social development possibilities in rural areas;
- Reduction of municipal wastes and residues;
- Substitution of fossil fuels and thus assuring a healthier environment and significant greenhouse gas emissions;
- Creation of energy security.

Currently, bioenergy accounts for 10% of global energy consumption, mostly used in traditional ways like burning biomass for heat and cooking.

## 1.6. Sources of biomass – Classification of biomass feedstocks

Biomass feedstocks are classified into 8 major groups:

- Dedicated Energy Crops

Dedicated energy crops can be grown on marginal land due to being non-food substances that can withstand the raw and un hospitable nature of these lands. These energy crops are divided into two categories, one pertaining to herbaceous energy crops and the other to short-rotation woody crops.

Herbaceous energy crops that are perennials that have the ability to live in such raw nature are harvested annually after blossoming to their full productivity at a 2 to 3-year interval.

These include such grasses as switchgrass, miscanthus (also known as elephant grass or e-grass), bamboo, sweet sorghum, tall fescue, kochia, wheatgrass, and others.

Short-rotation woody crops on the other hand are fast growing hardwood trees that have a 5 to 8-year interval of waiting before being harvested at full potential. These include hybrid poplar, hybrid willow, silver maple, eastern cottonwood, green ash, black walnut, sweetgum, and sycamore.

Theoretical consideration of solar capture by plants reveals C4 perennial energy crops to be as efficient as photovoltaic devices to the point of charge separation in photosynthesis. Any subsequent large energy losses occur in the synthesis of stored energy (carbohydrate) and in building and maintaining the system, something man-made photovoltaic devices are unable to do.

The annual yield of a plant with a given genotype at a given location is the product of the total solar radiation and the efficiencies with which the crop first, intercepts that radiation; second, converts it into chemical energy in the form of plant biomass; and third, partitions it into the harvested component. [13]

- Agricultural Crops

These include commodity products such as cornstarch and corn oil, soybean oil and meal, wheat starch, and vegetable oils. Processing these crops into sugar and other extractives can also help in producing plastic as well as other chemical products.

- Agriculture Crop Residues

They include crop wastes that are not usually harvested and left in an agricultural field or the residues left after crops have been harvested like leaves, stalks, stubble, cobs, etc.

- Forestry Residues

Residues often are obtained from precommercial thinning in young stands or removing old stands, non-harvested biomass in logging sites in commercial hardwood and softwood stands. [14]

- Aquatic Plants

Aquatic plants from the seaweed and marine microflora play a role in biomass production. Some of these latter organisms are algae and giant kelp.

As an aquatic organism, algae grow in diverse watery media from freshwaters to seawaters and damp soil; in a fast manner that allows its adaptation in these media, whilst taking in carbon dioxide out of the atmosphere, serving as a great potentially home-grown source of renewable, sustainable fuel; for example, Algenol, has some algae strain that can produce ethanol directly, and the system can then convert remaining biomass into hydrocarbon fuels such as biodiesel, gasoline, and jet fuel. The biorefinery has helped Algenol exceed its milestone of 9,000 gallons of ethanol per acre per year at peak productivity, with an additional 1,100 gallons per acre per year of hydrocarbon fuels.

Land plants currently used to produce biodiesel and other fuels include soy, canola, and palm trees. For the sake of comparison, soy beans produce about 50 gallons of oil per acre per year; canola produces about 160 gallons per acre per year, and palms about 600 gallons per acre per year.

But unlike the plants above, some types of algae can produce at least 2,000 gallons of oil per acre per year, due to its production of fatty lipid cells that contain fuel alongside its photosynthesis process which gives oxygen as a by-product, removes carbon dioxide from the atmosphere, and uses phosphates, nitrogen, and trace elements to grow and flourish. [15,16]

- Biomass Processing Residues

In the use of biomass feedstocks such as wood, residues linger after the process ends. But in return these residues can be used again as a source of energy with minimal cost and high effectiveness as such unused branches and sawdust for heat and fire as an example.

Due to the non-ceasing increase of urbanization, industrialization and population growth around the globe, the amount of food wastes is instantly escalating. So, due to the process of HTL discussed above they consequently represent a widely available resource in the form of biomass, and their use as a raw material in decreasing the environmental cost accompanied with their disposal.

Due to their high moisture content, a solution such as dry valorization is highly unfavorable due to its relative excessive cost. Hence, its alternative, HTL, which converts wet biomass into a crude-like oil with higher heating values up to 40 MJ/kg using subcritical water ( $T=250\text{--}370\text{ }^{\circ}\text{C}$ ,  $P=10\text{--}30\text{ MPa}$ ) [17]

- Municipal Waste

Municipal waste, once a recurring Eco devastating issue for extreme environmentalists, has now become a somewhat rejuvenating subject since it has become one of the important sources of biomass production after its treatment and cultivation. Examples of the latter range from organic matter as sewage to the industrial and commercial wastes, but excluding wood and agriculture waste residues.

For the transformation of wet solid wastes into biocrude or bioenergy a process such as hydrothermal liquefaction must be used. This process is a viable thermochemical process that gives out biocrude which is hydro processed to liquid transportation fuel blend stocks. A feasible percentage of biogenic feed carbons ranging from 20-50% should be installed for the enhancement of this process on an industrial scale.

One of the interesting alternatives in biofuel coming from several conversion processes of solid wastes is Bioethanol ( $C_2H_5OH$ ), one of its properties is that its oxygenated (35%) with a bio base, providing an ability to reduce particulate and  $NO_x$  emissions in compression ignition engines for example.

According to the diagram below, a process done on municipal waste or its transformation into bioenergy or bioethanol in this case is shown.

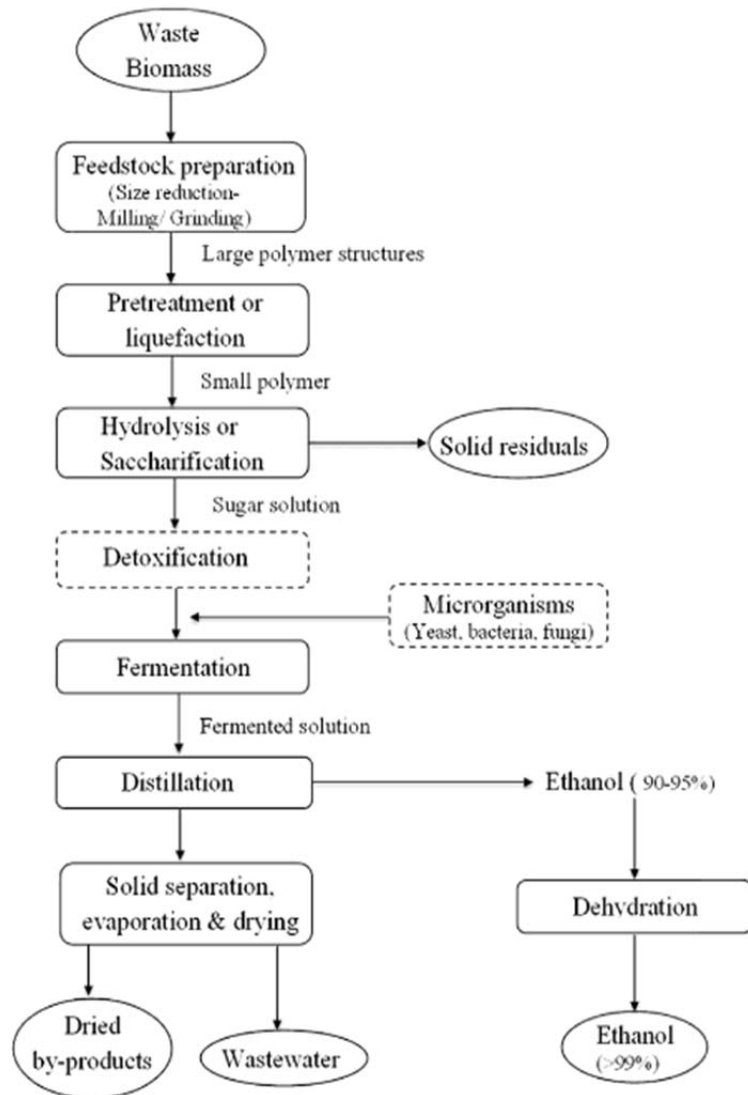

FIGURE 8.1 General block flow diagram of bioethanol production from waste biomass. Modified from M.J. Taherzadeh, P.R. Lennartsson, O. Teichert, H. Nordholm, *Bioethanol production processes*, in: *Biofuels Production*, John Wiley & Sons, Inc., Hoboken, NJ, USA, 2013, pp. 211–253.

Fig.8. Bioethanol Production from Agricultural and Municipal Wastes [18]  
(Source: Current Developments in Biotechnology and Bioengineering Solid Waste Management)

- Animal Waste

Animal wastes are obtained from farms and animal-processing operations. They are a complex mixture of organic materials, if left unprocessed, they can significantly pollute the surrounding environment. Through anaerobic digestion, which are basically a series of



biological reactions where certain type of bacteria break down biodegradable material in the absence of air. These wastes can be used to make many products, including energy.

### 1.6.1. Wood



Fig.9. Wood [19]

(Source: <https://www.google.hu/search?q=wood+biomass&rlz>)

Wood has been used by humanity for decades as a main source of heat for cooking and for light. Wood continues to be an essential fuel for various ways of consumption especially in developing countries.

In Europe, wood is still used highly in the renewable energy domain. The chart below shows wood and wood product in gross inland energy consumption for various European countries in 2014.

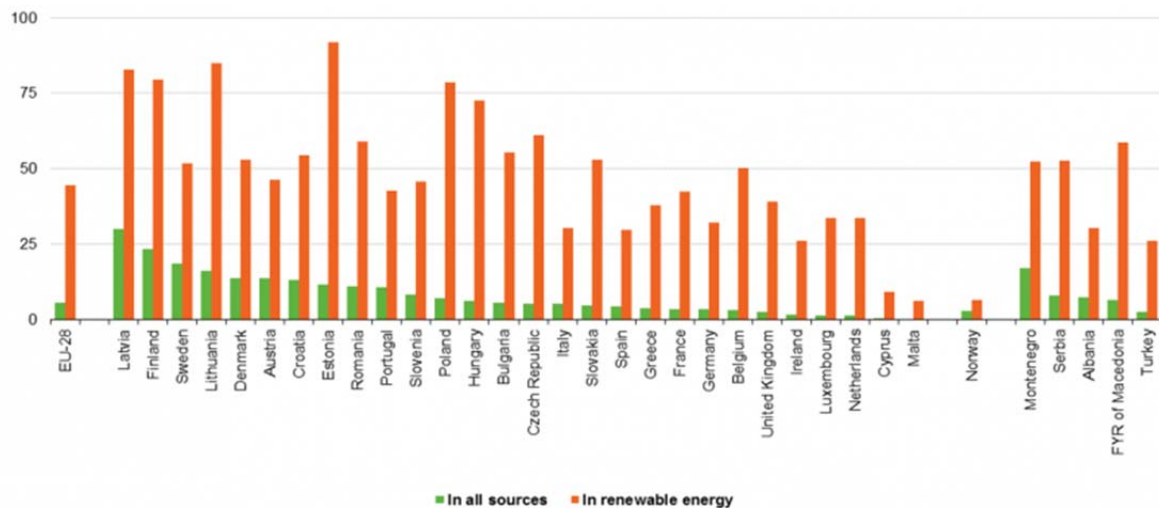

Fig.10. Wood as a source of energy [20]

(Source:[http://ec.europa.eu/eurostat/statistics-explained/index.php/Wood\\_as\\_a\\_source\\_of\\_energy](http://ec.europa.eu/eurostat/statistics-explained/index.php/Wood_as_a_source_of_energy))

Wood is a composite of cellulose, lignin and hemicellulose (43%, 36% and 22%, respectively). A typical analysis of dry wood yields carbon (52%), hydrogen (6.3%), oxygen (40.5%) and nitrogen (0.4%). The proximate analysis of wood shows the following components:

1. wood: volatile matter (80%), fixed carbon (19.4%) and ash (0.6%);
2. bark: volatile matter (74.7%), fixed carbon (24%) and ash (1.3%).

### 1. Forestry and waste of forestry related industries

Forestry residues that are used for advanced biofuel production can be summed up in two types:

- Harvest residues that are left in the forests after logging such as stems, roots, branches, foliage, etc.
- Complimentary fillings, which describe the difference between the maximum need for consumption and the actual harvest needed to satisfy round wood demand.

### 2. Energy forests

Energy forests are getting major interest nowadays when talking about renewable energy resources and for meeting the increasing global energy demand. Energy forests are described as a new type of forestry that's main goal is containing fast-growing trees that provide a higher level of energy when converted to fuel. The main aim of these forests is to produce biomass for energy production purposes. There are two types of energy forestry, short rotation coppice - includes tree crops like willow, Eucalyptus, and many others which can be harvested and cut after 2-5 years - and short rotation forestry.

### 3. Processing wooden biomass

Logs and chips are the two main forms of forestry-derived wooden biomass. Wood pellets are produced from sawmill or wood product processing plant residues and are made in large scale pellet mills. They are unlikely to be appropriate for community scale production. Each wood heating system will have particular fuel requirements e.g. some boilers are designed for larger woodchip sizes than others.

*Processes involved:*

- a. **Logs** - Once harvested, wood needs to be cut to uniform lengths, stacked off the floor, in the woodland for drying and ultimately chopped into logs and transported off site for use in boilers or stoves.



Fig.11. Wooden Logs [21]

(Source: <http://cooroyoutdoor.com/our-products/chainsaws/wooden-logs/>)

- b. **Woodchips** - once harvested wood needs to be cut to uniform lengths, stacked for drying, transported to a processing site if outside the woodlands, chipped using a chipper and screen and transported to the woodchip boiler.



Fig.12. Wood chips [22]

(Source: <http://www.photos-public-domain.com/2010/10/03/red-wood-chips/>)

- c. **Wood pellets** - wood pellets are produced on a factory scale by forcing dried sawdust and clean wood by-products (from sawmill or forestry activities) through holes in a rotating die to form tight pellets. [23]



Fig.13. Pellets [24]

(Source: <http://www.framfuels.com/>)

### 1.6.2. Energy grasses

Conventionally, most solid biomass heating fuels—woodchips, wood pellets, and cordwood—came from forests and the forest products industry. Over the past 15 years, however, growing crops (both herbaceous and woody) specifically for energy has gained widespread appeal, and perennial grasses such as Switchgrass, Miscanthus, and Reed Canary grass present exciting new renewable energy options.

Perennial grasses are now being used as a solid fuel in co-fired coal power plants as well as targeted as a choice feedstock for such advanced biofuels as cellulosic ethanol. Despite this focus on generating electricity and producing liquid fuels, perennial grasses can also be pressed into pellets, briquettes, and cubes and used as a heating fuel to replace or complement fuels made from wood fibers. Including a thermal component in the use of solid biomass for energy increases a combustion system's efficiency more than threefold. [25]

### 1.6.3. Agricultural organic residues

Organic waste or materials obtained from biomass remain at least partly un-degraded for longer times, this effectively removes carbon from the atmosphere. This is the case, for example, when compost that has been spread on agricultural land is only slowly mineralized and increases the soil organic matter, or when organic material in landfills decays only over many years.

Disposal and treatment of organic waste represents a major challenge for the waste industry. Anaerobic digestion is an alternative to composting for a wide range of organic substances including livestock manure, municipal wastewater solids, food waste, industrial wastewater and residuals, fats, oils and grease, and other organic waste streams. Diverting

organic waste to facilities that contain anaerobic digestion technology could lower greenhouse gas emissions, specifically methane released from landfills as waste breaks down. In addition to waste management, anaerobic digestion provides a renewable source of biogas, which can be burnt to generate heat or electricity or upgraded to be used as a vehicle fuel.

Such organic wastes alongside energy crops can be put under microbial conversion to be transformed into biogas widely used in energy production, resource recovery and waste treatment. As well as its role, In the reduction of greenhouse gas emissions and its improvement of the manure and organic waste management system since it can replace mineral fertilizers. [26]

### **1.7. Design of the Biomass Boiler**

What Does a Wood-Chip System Look Like?

Switching from an electric generator to a biomass based heating system can be challenging.

Biomass warming plants are comparable in their practical parts to warming plants that keep running on traditional powers. They incorporate substantial volume fuel stockpiling ability, a means for moving the fuel from the capacity canister to the burner, a burner and heater to consume the fuel also, extract the useable heat from combustion, and association with a chimney that scatters the burning gases. Engine compartments or heater houses for biomass frameworks are normally bigger than regular boiler rooms, since wood boilers are bigger and the fuel handling gear consumes up additional space. The chimney of a biomass framework is typically taller than that for an oil or, on the other hand gas framework.

All things considered, a biomass framework looks much like a regular heater room, with the exception of its fuel chimney. While oil and fluid propane (LP) gas are ordinarily put away in covered tanks (petroleum gas requires no on-location capacity), wood-chip containers might be above or beneath the ground.

If the wood-chip container is subterranean, which is the regular case, just its chimney is noticeable. Over the ground containers may look simply like homestead storehouses: they are round concrete or metal storehouses of different structures and heights. As a rule, biomass energy frameworks in the 1-10 MMBtu size range don't adjust the external appearance of the facility. They fit into the look of the current structures and the encompassing region.

If operated appropriately, they don't create obvious smoke. In light of the fact that the biomass fuel generally consumed is green, or near one-half water, in chilly climate the chimney may demonstrate a plume of consolidated water vapor. Interviews with many framework administrators bolster the conclusion that scent produced by the fuel or the smoke is never an issue.

The components of a biomass boiler system include:

1. The fuel storage facility
2. Boiler room to house the equipment
3. Fuel handling equipment to move the fuel from storage to the boiler
4. A chimney to exhaust the gases
5. Exhaust gas cleaning devices
6. Ash disposal equipment

The person operating the plant is also essential to the success of the system.

### A Typical Biomass System

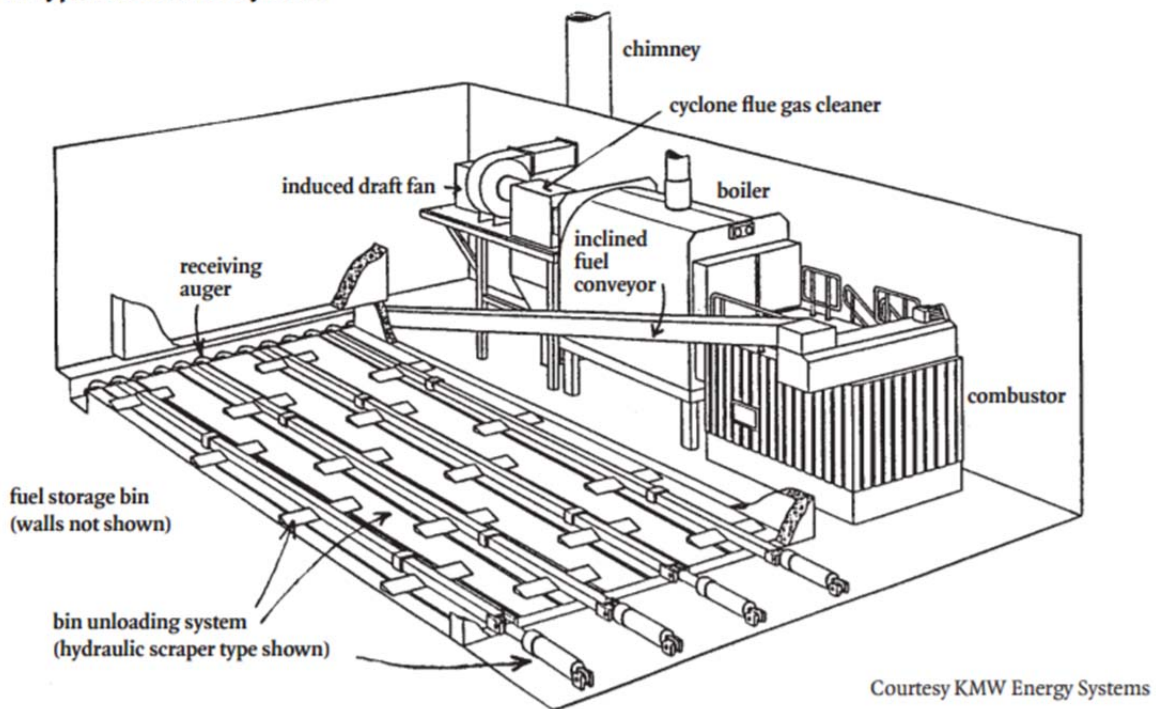

Fig.14. Typical biomass system [27]

(Source: <http://www.biomasscenter.org/pdfs/Wood-Chip-Heating-Guide.pdf>)

Factors to be considered:

1. The characteristics of the fuel to be used

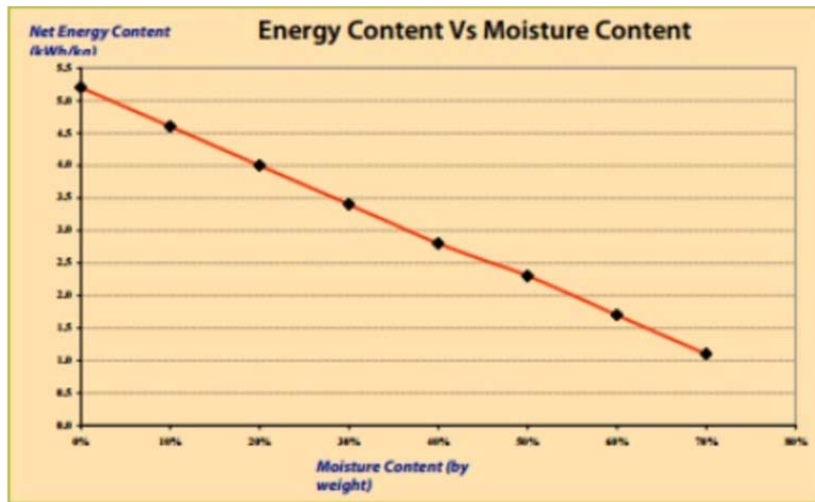

Fig.15. Energy Content Vs Moisture Content [28]

(Source: <https://www.slideshare.net/ConorDorman/improving-the-energy-efficiency-of-fota-wildlife-park> )

All biomass fuels are made up halfway of water. Fuel dampness is usually expressed on a wet premise: a fuel that is half water by weight would have a 50% wet basis moisture content. Fuels are likewise once in a while described on a dry premise. A similar fuel would have a 100% dry premise dampness content, in light of the fact that the heaviness of water is equivalent to the weight of dry wood. Most purchased biomass fuel is green or undried, with 30-55% of the conveyed weight being water. All references to fuel moisture are on a wet premise.

Fuel ought to dependably be shielded from precipitation to counteract solidifying and clustering, treating the soil, and warm development. Biomass fuel that has dependably been kept under cover will dry out if left after some time. In most systems, however, the fuel does not remain in the capacity container sufficiently long to dry significantly, or to start treating the soil on the off chance that it has been rained on. High fuel dampness levels diminish consuming efficiency in light of the fact that the significant of the fuel that is water is not burnable. Efficiency is likewise lessened since an expansive piece of the vitality accessible in the wood itself is utilized to warm up and dissipate this dampness. One approach to increment efficiency is drying the fuel on location. Be that as it may, the cost of hardware to do this is high. Hence, fuel driers are never found in offices measured underneath 10 MMBtu.

Fuel	Net Calorific Value kWh/kg	Bulk density kg/m <sup>3</sup>	Volumetric energy density kWh/m <sup>3</sup>
Wood (solid, oven dry, 0% mc)	5.3	400-600	2,100 - 3,200
Wood pellets (~8% mc)	4.8	650	3,100
Log wood (stacked, 20% mc)	4.1	350-500	1,400 - 2,000
Wood chips (30% mc)	3.5	250	870
Miscanthus (bale, 25% mc)	3.6	140-180	500 - 650
Heating oil	11.8	845	10,000
Anthracite	9.2	1,100	10,100
House coal	7.5-8.6	850	6,400 - 7,300
Natural gas (NTP)	10.6	0.9	9.8
LPG	12.9	510	6,600

Table 3. Heating values for different types of fuels [29]

(Source: [https://ec.europa.eu/energy/intelligent/projects/sites/iee-projects/files/projects/documents/forest\\_guide\\_for\\_designers\\_and\\_architects\\_en](https://ec.europa.eu/energy/intelligent/projects/sites/iee-projects/files/projects/documents/forest_guide_for_designers_and_architects_en))

Moisture Content (MC)	Gross Heating Value (GHV-AF)
oven-dry	8500
25%	6375
30%	5950
35%	5525
40%	5100
45%	4675
50%	4250
55%	3825
60%	3400

Table 4. Moisture content and energy output [30]

(Source: <http://www.biomasscenter.org/pdfs/Wood-Chip-Heating-Guide.pdf>)

Efficiency can be defined by the amount of useful heat output from combustion, divided by the heat input of the fuel. For efficiency calculations, the input fuel's energy content can be characterized either by its as-fired gross heating value (GHV-AF) or by its net heating value (NHV). For obvious reasons, there is a need to be consistent in the way in which efficiency is calculated.

Green wood combusts with relatively low efficiency because it contains a large amount of moisture. GHV based efficiency calculations look at the total heating potential of the wood,



including the energy that is “wasted” in vaporizing water and in not condensing water vapor in the flue gases. When efficiency calculations are based on NHV, which removes fuel moisture from the equation, efficiencies increase significantly compared to efficiencies calculated on a GHV basis. Some European manufacturers (or manufacturers with product lines based on European technology) report their efficiencies based on NHV. Prospective buyers must be sure that they know what heating value basis is being used when they evaluate the efficiency of different combustion systems.



Fig.16. Combustion efficiency. [31]

(Source: [https://www.researchgate.net/figure/270398042\\_fig4\\_Fig-7-Combustion-ef-fi-ciency-characteristics-of-a-typical-woodchip-furnaceboiler](https://www.researchgate.net/figure/270398042_fig4_Fig-7-Combustion-ef-fi-ciency-characteristics-of-a-typical-woodchip-furnaceboiler))

2. The energy capacity and pattern of demand to be met

How big should the biomass system be?

How to decide the adequate Btu yield and by what method should the backup system be sized.

These will be discussed in the following points depending on the objectives to be carried.

Regardless of the target, net oversizing of the biomass plant should be deliberately avoided, due to the natural tendency of designing oversized biomass plants which will ultimately affect the efficiency of the plant, thus consuming too much fuel and the possibility of generating too much smoke in low load scenarios.

The primary objective here is to minimize backup fuel use. In our case the system should be sized to cover the full heating load of the greenhouse in use. In cold weather (period of high peak load) the system will be running almost constantly at full potential output.

The backup fuel system would not be needed to meet the load except for short periods.

Most of the time the system will be running less efficiently due to the fact that high peak load conditions are less frequent.

In this case, poplar tree woodchips are going to be used a fuel for the heating system, being harvested from the energy forest nearby the study farm.

### 3. The cost and the performance of the equipment

Semi-automated greenhouse heating systems usually cost less than those fully automated systems found in schools or hospitals. There are 3 main reasons for this difference in system costs.

Firstly, tractor based semi-automated systems that use tractors to transport the wood chips from the storage bin to the daily bin are inexpensive to be built. The construction variations also affect the differences in the total cost of building a greenhouse heating system, being cheaper

when less expensive construction material is used and vice versa in case the higher end products are used. Further savings come from already owning some handling equipment and controls.

Secondly, due to this installation system being used for a greenhouse heating purpose, most of the resources to be used are already available on site and the greenhouse staff can also be used to install the biomass system, thus evading the high costs of hiring architects/engineers and labor forces.

Thirdly, sophistication and additional features heavily affect the payload of the project because while using a less complicated system with no exhaust gas cleaning equipment may reduce cost levels, it would not offer the comfort of the higher end micro-processor fully automated self-cleaning equipment but would considerably decrease the total price tag of the greenhouse project.

### 4. Local legislations relating to buildings and the environment. [27]

## 1.8. Design of the biomass heating system

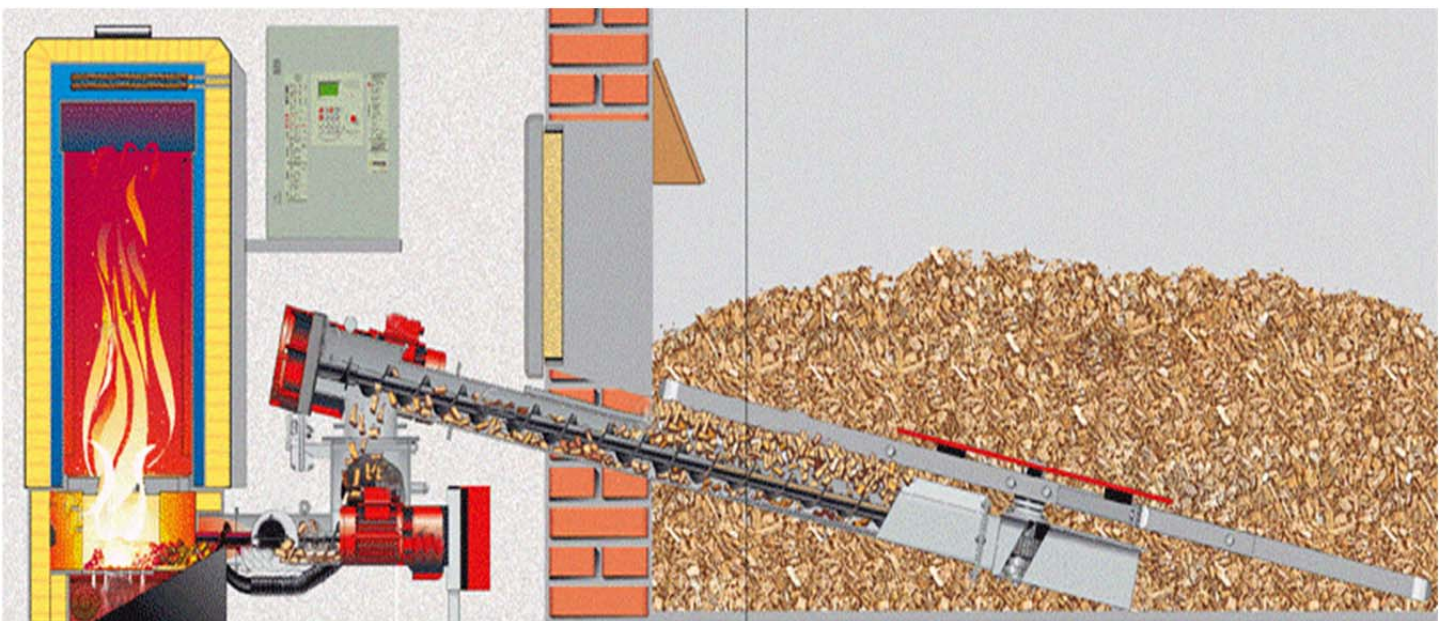

Fig.17. Wood chip heating system [32]

(Source: <http://www.williamsrenewables.co.uk/biomass/woodchip-boilers/>)

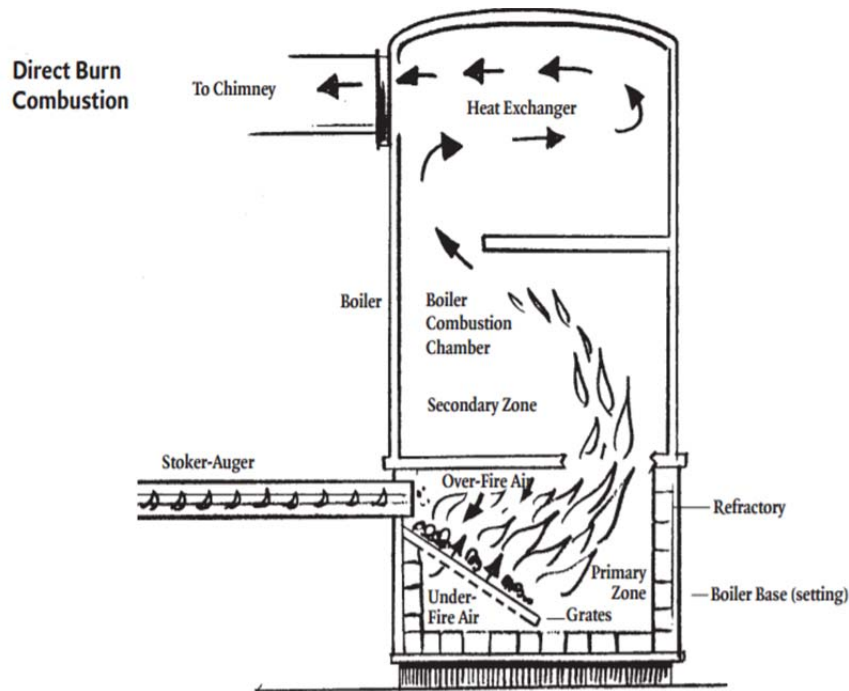

Fig.18. Biomass Boiler [27]

(Source: <http://www.biomasscenter.org/pdfs/Wood-Chip-Heating-Guide.pdf>)

### The fuel storage system

In this case a below-ground concrete bin is chosen, having the following advantages:

- In cold weather conditions the underground bins prevent the chips from freezing due to the bottom layers of chips, which are below frost levels.
- No mechanical equipment must be used to discharge the chips into the bin because self-unloading trucks can use gravity for ease of discharge.
- The underground position of the bin aids in the visual aspect of the compound, not obstructing or deterring as those built above ground.



Fig.19. Storage bin and fuel handling system

### **The fuel handling system**

Biomass is conveyed using automated equipment, from the storage facility into the boiler room and eventually the combustion chamber.

Beginning with the fuel removal from the storage bin, which is done using hydraulic scrapers (with a back-forth motion) at the base of the bin, discharging fuel from the bin and feeding a horizontal receiving auger that runs along one of the bin's sides which transports the fuel towards the combustion chamber.

This system profits of a small metering bin located between the storage bin and combustion chamber which separates the rapid flow of wood chips being transported from the bin carefully controlling the feed rate of the fuel that goes through to the combustion chamber.

## Combustion Chamber

In this case, a single combustion chamber is being used which is located directly under the boiler, set on a base supporting the boiler.

The grates and fuel feed systems are in the refractory lined setting where air is injected into it, both below and above the grates.

In this design, the furnace volume of the setting is open to the combustion chamber of the boiler above it, where the hot gases will rise up from the grate area into the combustion chamber of the boiler where the combustion of the hot gases and solid particles is completed.

Properly designed with effective combustion controls, direct burn systems are capable of highly efficient combustion with low emissions.

This boiler is chosen to be of 160 kW power.



Fig. 20 . Combustion Chamber.

### 1.8.1. Other Equipment

For this installation it is necessary to size a proper pump, a reservoir, an expansion vessel and an adequate length of steel pipes to heat the greenhouse.

## 1.9. Impact of the project for the rural development

The concept of ‘sustainability’ has been enhancing considerably in the last three decades, but only a few people have been concerned about this matter before. Development was considered to have infinite possibilities and the concept of scarcity was never taken into consideration on the way towards a better life. The main scope was believed to be the defeat of nature, and not the twisting and shaping of the world with nature towards a “wealthy society” with respect to nature’s rules. All of these thoughts came from the idea that natural resources are endless – no one could be bothered in the case of exhaustion of old shafts and wells, because new mine-shafts and oil wells were discovered. In the Articles of Agreement of the International Monetary Fund and the World Bank of 1944 is mentioned that the resources of our planet are infinitely rich and global welfare can be guaranteed for all. Those Articles were writing about Earth’s huge reserves that could be enough for even 50 billion people. Regarding the downfall of raw materials, the human insight was without a question believed to be able to solve the emerging problems by finding substitute resources, while an energy crisis was considered to be impossible.

Sustainable development is described as the development that meets the needs of the present without compromising the ability of future generations to meet their own needs. It links two main key concepts, the concept of needs and the concept of limitations.

The decline of polluting activities could greatly boost the implementation of the principles of sustainability. Despite the decline of industrial activities and the relative backwardness of a region the existing production is only partly sustainable. Sustainability can be measured against the following criteria:

- Management of natural resources
- Biological and operational structure harmonized with its environment, degree of intensity
- Minimized use of chemicals and artificial inputs
- Retained biodiversity
- The responsibility of sustainable development at a global scale [34].

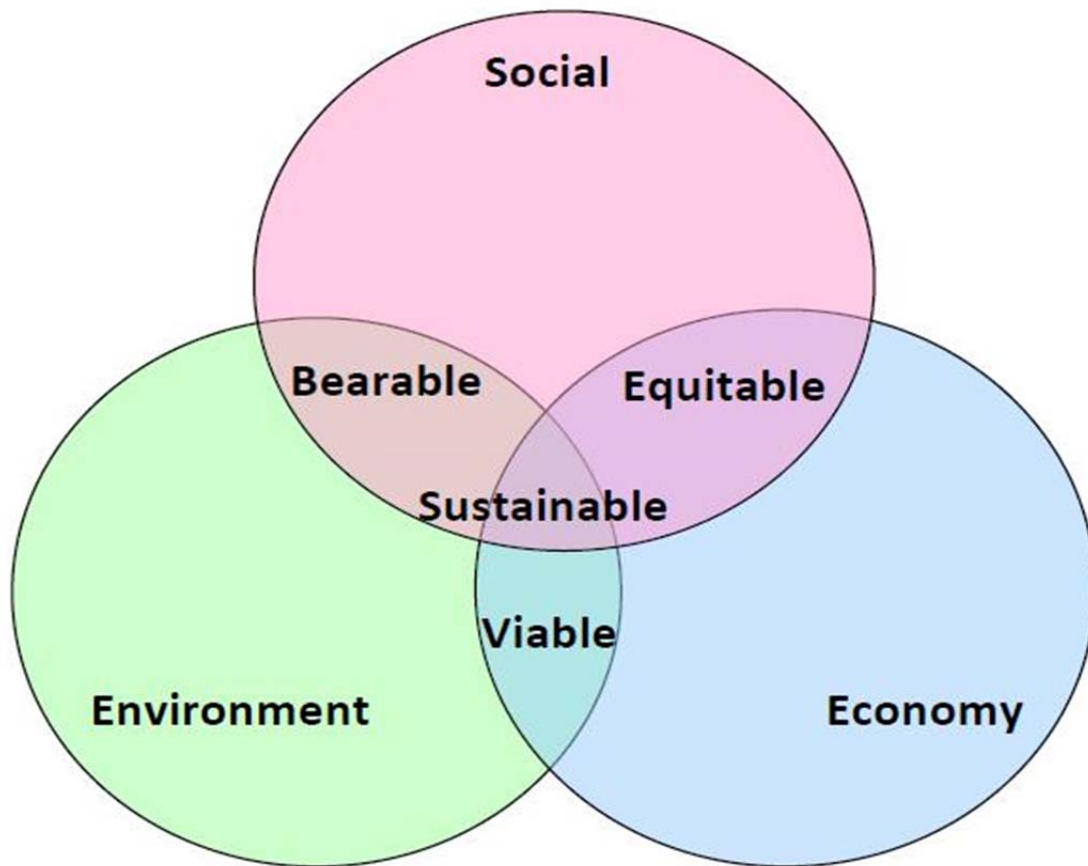

Figure 21. Sustainable development main basis. [33]

(Source:

[https://www.google.hu/search?q=sustainable+development&rlz=1C1CHZL\\_enRO733RO733&source=lnms&tbm=isch&sa=X&ved=0ahUKEwj9hqTFmMPTAhXGJZoKHeYYAa4Q\\_AUICigB&biw=1536&bih=735#imgdii=8DWwk6VE79YLNm:&imgcr=ZmuRVt3bf1FUtM:\)](https://www.google.hu/search?q=sustainable+development&rlz=1C1CHZL_enRO733RO733&source=lnms&tbm=isch&sa=X&ved=0ahUKEwj9hqTFmMPTAhXGJZoKHeYYAa4Q_AUICigB&biw=1536&bih=735#imgdii=8DWwk6VE79YLNm:&imgcr=ZmuRVt3bf1FUtM:))

### Environmental impact

As shown in the introduction above, fossil fuels are highly pollutant while renewable energies – in this case biomass- are clean energies that help our environment somehow regain its vital signs. The most obvious environmental impacts that using biomass for energy production are:

- Biomass can produce a considerable amount of energy beside the fact that it can have almost zero carbon footprint if used in a proper way. For example, even burning biomass can be clean low on pollution if burnt at a specific temperature.
- Forest residues, animal wastes and municipal wastes would be used for a good cause instead of dumping them and polluting the soil and water.

- Greenhouse gas emissions would be kept under control, minimizing the carbon dioxide and other toxic gases from our Earth's atmosphere.

### Social and Rural Impact

Consumption of renewable energies in rural areas specifically has a positive direct impact on social and rural development in those areas.

The use of biomass for energy production can present the following impacts in rural areas:

- Minimizing unemployment by creating job offers in many fields like farming, installation of boilers, and power plants where electric energy from biomass is produced.
- Low energy bills since biomass is way cheaper than any fossil fuel used nowadays.
- Attraction of investments in the field of energy production improving the economic status of the rural area.
- Touristic attractions.
- Encouraging the investments in new farms and the production of energy crops and energy forests.
- Minimizing migration of the habitants and the youth by creating the favorable conditions of job offers and proper livelihood.
- Educating people and informing them about their strong impact upon the environment and the steps that should be taken in order to live at peace with our surrounding.
- Starting educational courses at schools about farming, agriculture and renewable energies.
- Creating extra money for land owners that would sell their share of energy crops and biomass to energy producing units.
- Innovating and rejuvenating the area with numerous projects knowing that the economic status would be considerably blooming.
- Raising the family incomes in rural areas by producing their own energies, would give them the ability to invest in other projects that lead to rural development.
- Sustaining the farm's stability and evolution towards future expansions that lead to a larger paprika production.



### 1.10. Conclusion

Shifting from an electric heating system to a wood chip based heating system can be beneficial in various fields; economic, environmental and social.

- Wood fuel is cost effective being economically competitive with other fuels used for heating also woodchips are often stable, not depending on exogenous factors such as fossil fuels.
- Wood chips are small in size and boilers can be fed through an automated system, being easy to store and producing a minimal amount of ash
- Wood chips are easily obtainable and available if properly used due to the fact that they are green, renewable resource and a sustainable fuel which does not produce carbon dioxide emissions which harm the environment. The amount of dioxide emitted through burning is roughly equivalent to the amount absorbed during the growth of trees.
- This wood chip boiler heating system is energy-efficient requiring minimal user input and easy cleaning labour as well as affordable maintenance and supervision.
- This wood chip heating system will be able to support local economies because the wood chips are locally produced providing more jobs for local people and businesses such as wood chip machine operators as well as transport companies, that can lead to energy independence.

The financial side for Tass-puszta to pursue the installation of a woodchip heating system are very good, favourable economics are driven by substituting an electric generator high-cost low-efficiency system for the more advantageous low-cost high-efficient heating system that runs on locally produced woodchips.

From an economic point of view, the investment and project costs, however, will be recovered in time through fuel cost savings.

## 1.11. References

- [1]. <http://www.worldenergyoutlook.org/media/weo2010.pdf>
- [2]. [http://www.worldwatch.org/brain/images/press/news/vs05-world\\_oil.jpg](http://www.worldwatch.org/brain/images/press/news/vs05-world_oil.jpg)
- [3]. <http://www.eria.org/Energy%20Situation%20in%20the%20World.pdf>
- [4]. <https://energy.gov/science-innovation/energy-sources/fossil>
- [5]. International Atomic Energy Agency
- [6]. <http://energyinformative.org/fossil-fuels-pros-and-cons/>
- [7]. <https://www.weforum.org/agenda/2016/04/4-charts-that-show-the-rise-of-renewables/>
- [8]. <http://www.altenergy.org/renewables/renewables.html>
- [9]. [http://www.se4all.org/sites/default/files/IRENA\\_RE\\_Jobs\\_Annual\\_Review\\_2016.pdf](http://www.se4all.org/sites/default/files/IRENA_RE_Jobs_Annual_Review_2016.pdf)
- [10]. <https://mapcarta.com/18433856>
- [11]. [https://www.worldweatheronline.com/v2/weather-averages.aspx?locid=971022&root\\_id=954533&wc=local\\_weather&map=~/-tas-pusztaw-weather-averages/heves/hu.aspx](https://www.worldweatheronline.com/v2/weather-averages.aspx?locid=971022&root_id=954533&wc=local_weather&map=~/-tas-pusztaw-weather-averages/heves/hu.aspx)
- [12]. <http://www.nationalgeographic.org/encyclopedia/biomass-energy/>
- [13]. <http://www.sciencedirect.com/science/article/pii/S0958166908000542>
- [14]. <http://www.altenergy.org/renewables/biomass-feedstocks.html>
- [15]. [https://www.nasa.gov/centers/ames/news/features/2009/clean\\_energy\\_042209.html](https://www.nasa.gov/centers/ames/news/features/2009/clean_energy_042209.html)
- [16]. <https://energy.gov/eere/articles/making-algal-biofuel-production-more-efficient-less-expensive>
- [17]. \*\*\*Maxime Deniel, Geert Haarlemmer, Anne Roubaud, Elsa W.H., Jacques Fages, (2016). Energy valorisation of food processing residues and model compounds by hydrothermal liquefaction Book retrieved from URL.
- [18]. \*\*\* Jonathan Wong, R. Tyagi, Ashok Pandey (2016). Current Developments in Biotechnology and Bioengineering: Solid Waste Management Book, retrieved from URL.
- [19]. <https://www.google.hu/search?q=wood+biomass&rlz>
- [20]. [http://ec.europa.eu/eurostat/statistics-explained/index.php/Wood\\_as\\_a\\_source\\_of\\_energy](http://ec.europa.eu/eurostat/statistics-explained/index.php/Wood_as_a_source_of_energy)

- [21]. <http://cooroyouther.com/our-products/chainsaws/wooden-logs/>
- [22]. <http://www.photos-public-domain.com/2010/10/03/red-wood-chips/>
- [23]. <https://www.forestry.gov.uk/forestry/infd-9qqln7>
- [24]. <http://www.framfuels.com/>
- [25]. <http://www.biomasscenter.org/resource-library/fact-sheets/grass-energy-basics>
- [26]. <http://onlinelibrary.wiley.com/doi/10.1002/elsc.200620128/full>  
<http://ftp.jrc.es/EURdoc/JRC87124.pdf>  
<https://energy.gov/eere/energybasics/articles/anaerobic-digestion-basics>
- [27]. <http://www.biomasscenter.org/pdfs/Wood-Chip-Heating-Guide.pdf>
- [28]. <https://www.slideshare.net/ConorDorman/improving-the-energy-efficiency-of-fota-wildlife-park>
- [29]. [https://ec.europa.eu/energy/intelligent/projects/sites/iee-projects/files/projects/documents/forest\\_guide\\_for\\_designers\\_and\\_architects\\_en](https://ec.europa.eu/energy/intelligent/projects/sites/iee-projects/files/projects/documents/forest_guide_for_designers_and_architects_en)
- [30]. <http://www.biomasscenter.org/pdfs/Wood-Chip-Heating-Guide.pdf>
- [31]. [https://www.researchgate.net/figure/270398042\\_fig4\\_Fig-7-Combustion-efficiency-characteristics-of-a-typical-woodchip-furnaceboiler](https://www.researchgate.net/figure/270398042_fig4_Fig-7-Combustion-efficiency-characteristics-of-a-typical-woodchip-furnaceboiler)
- [32]. <http://www.williamsrenewables.co.uk/biomass/woodchip-boilers/>
- [33].  
[https://www.google.hu/search?q=sustainable+development&rlz=1C1CHZL\\_enRO733RO733&source=lnms&tbn=isch&sa=X&ved=0ahUKEwj9hqTFmMPTAhXGJZoKHeYYAa4Q\\_AUICigB&biw=1536&bih=735#imgdii=8DWwk6VE79YLNLM:&imgcr=ZmuRVt3bf1FUtM:](https://www.google.hu/search?q=sustainable+development&rlz=1C1CHZL_enRO733RO733&source=lnms&tbn=isch&sa=X&ved=0ahUKEwj9hqTFmMPTAhXGJZoKHeYYAa4Q_AUICigB&biw=1536&bih=735#imgdii=8DWwk6VE79YLNLM:&imgcr=ZmuRVt3bf1FUtM:)
- [34]. \*\*\*Dr. Robert Magda, Dr. Norbert Bozsik, Dr. Tamas Erdelyi, (2015). Sustainable Green Innovation. Gyongyos, Hungary: Vareg Hungary Commercial and Service Ltd.



# Calculation and Design



**Compilation of case studies of applying renewable energies to local development transnationally implemented**



Co-funded by the  
Erasmus+ Programme  
of the European Union



## 2. Calculations

### 2.1. Temperature in Tass-puszta, Hungary

The following table and graph show an archive of temperatures recorded in Tass-puszta in year 2016. [x]

Month	Minimum Temperature	Average Temperature	Maximum Temperature
Dec'15	1	4	7
Jan'16	-3	0	1
Feb'16	3	7	9
Mar'16	5	9	12
Apr'16	12	17	20
May'16	16	20	22
Jun'16	21	25	28
Jul'16	22	27	30
Aug'16	21	26	29
Sep'16	18	24	27
Oct'16	8	12	15
Nov'16	3	6	9
Dec'16	-3	0	4

Table 5. Minimum, average and maximum temperatures in Tass-puszta 2016.

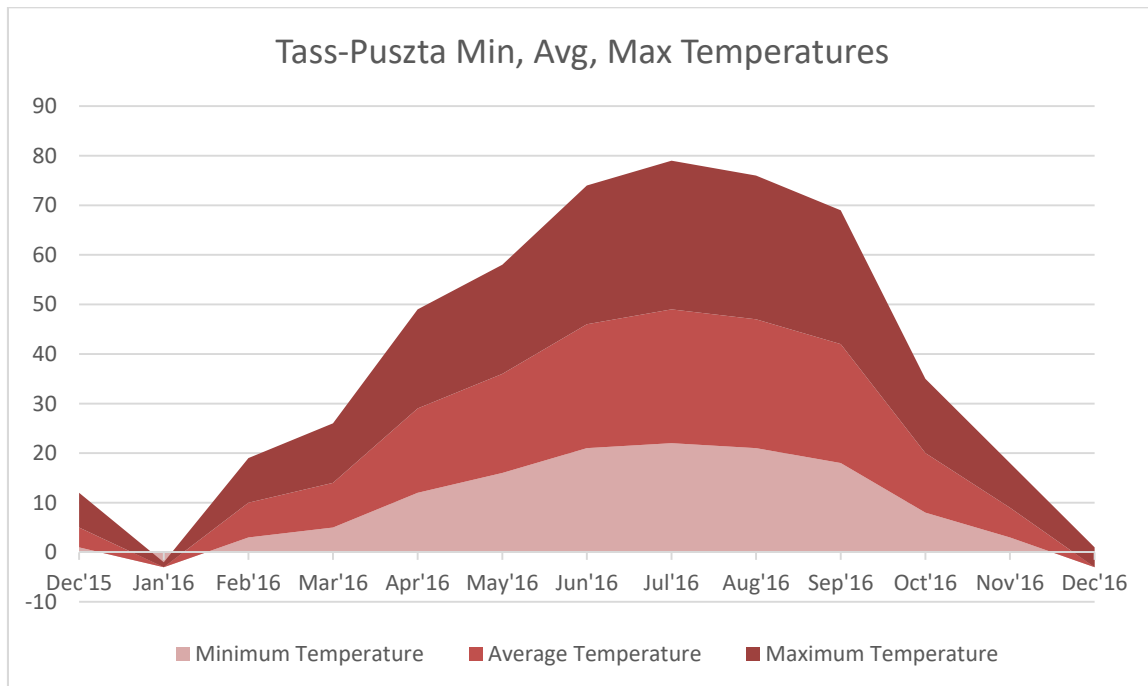

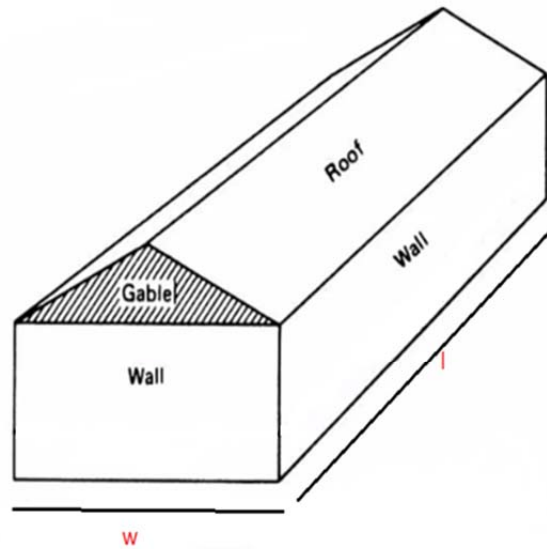

In order to calculate the heat demand of the greenhouse, it is essential to define the basic parameters of the latter. These parameters are defined as in the figure above.

Where:

$l$  is the length of the greenhouse = 80 m

$w$  is the width of the greenhouse = 10 m

$H$  is the height of the wall = 4 m

$h$  is the height of the gable = 1 m

## 2.2. Heat loss

Heat loss in this case can be calculated according to the results of three energy losses which include:

1. Structural heat loss
2. Thermal loss due to ventilation

### 2.2.1. Structural heat loss

Type of covering material	U Value (BTU/sq.ft°Fhr)	U Value (W/sq.mK)
Glass single layer	1.1	6.2414
Glass double layer	0.7	3.9718
Glass triple layer	0.5	2.837
Polyethelene single layer	1.1	6.2414
Polyethelene double layer	0.7	3.9718
Double acrylic or polycarbonate	0.6	3.4044
Corrugated polycarbonate	1.2	6.808
Concrete block	0.5	2.837
Plywood	0.7	3.9718
Concrete poured	0.8	4.5392
Greenhouse with thin thermal curtain	0.3-0.7	1.7022-3.9718
Uninsulated perimeter	0.8	4.5392
Insulated perimeter	0.4	2.2696

Table 6. U value for structural through conduction.

The following considerations are taken into account:

- The roof and gable are made of a double glass layer
- The walls are made of double polyethylene layer
- The floor is made of poured concrete

In this case, the minimal outside temperature is considered to be  $-3^{\circ}C$

To calculate the structural thermal loss, the following relation is given:

$$Q = U \cdot A \cdot \Delta T$$

Where:

- Q is the heat loss measured in Watts
- U is the thermal loss coefficient  $W/(m^2K)$
- A is the area measured in  $m^2$
- $\Delta T$  is the temperature difference;  $T_{inside}-T_{outside}$  measured in Kelvin



Element	U (W/m <sup>2</sup> K)	A (m <sup>2</sup> )	$\Delta T$ (K)	Q (W)
Roof	2.409	800	25	48,180
Gable	2.409	10	25	602.25
Walls	2.049	720	25	43,362
Floor	2.38	800	18.85	35,890
<b>Total Thermal Loss/ Energy demand</b>				<b>128,034.25</b>

Table 7. Total thermal loss.

### 2.2.2. Thermal loss due to ventilation

Considering that the index of minimum renovation inside the greenhouse has a value of 1(1/h), we can calculate the minimum flow of air renovation and respectively the coefficient of thermal loss due to ventilation using the following relations:

$$V_i' = V_i \cdot n_{min}$$

$$H_{v,i} = 0.34 \cdot V_i \cdot n_{min}$$

Where  $V_i$  is the volume of the greenhouse under study.

Thermal power loss due to ventilation is calculated using the following relation:

$$Q_v = H_{i,v} \cdot \Delta T$$

Interior Volume [ $m^3$ ]	3,600
Outside Temperature [K]	270
Inside Temperature [K]	295
Minimum Index of air renovation [1/h]	1
Minimum air flow $V'_{min}$ [ $m^3/h$ ]	3,600
Thermal loss coefficient $H_{v,i}$ [w / k]	1,224
Thermal power loss due to ventilation [W]	30,600

Table 8. Thermal power loss through ventilation.

$$Q_{total} = Q_{structural} + Q_{ventilation} = 158,634.25 \text{ W}$$

### 2.2.3. Annual Heat Demand

Base temperature is defined as the temperature at which a building or any other type of construction does not need heating or cooling. It is also called comfort temperature. In this case of a greenhouse, base temperature is different from the normal base temperature of the city or location, because a greenhouse has to maintain a certain temperature at which the agricultural output remains intact. In our case of a paprika growing greenhouse, the base temperature is 18 degrees Celsius. The heat degree days is calculated utilizing the following relation:

$$HDD_{18} = (18 - T_{avg}) \times \text{Number of days}$$

For the calculation of HDD, during summer months, the boiler is not used due to the hot weather.

Month	Number of days	Average Temperature (°C)	HDD <sub>18</sub>
January	31	0	558
February	28	7	308
March	31	9	279
April	20	17	20
May	-	20	-
June	-	25	-
July	-	27	-
August	-	26	-
September	-	24	-
October	31	12	186
November	30	6	360
December	31	4	343
<b>Total HDD<sub>18</sub></b>			<b>2,054</b>

Table 9. Total HDD

The annual energy demand can be calculated using the total HDD<sub>18</sub> calculated above and the total heat loss  $Q_{total}$  as in the following relation:

$$E = \frac{HDD_{18} \cdot Q \cdot \text{hours/day}}{T_{comfort} - T_{outside}}$$

Where,

- $Q$  is the total heat loss expressed in kW

- Hours/day is the total heating hours per day, 24 hours in this case.

Therefore, the annual energy demand is equal to 278,170 kWh

### 2.3. Pipe heating system

In order to calculate the necessary pipe length needed for the greenhouse, heat dissipated by 1m<sup>3</sup> of a steel pipe must be calculated.

Given:

$$\bar{q}_l = \frac{T_i - T_e}{\frac{1}{\pi d_i \alpha_i} + \frac{1}{2\pi \lambda_{st}} \ln \frac{d_e}{d_i} + \frac{1}{\pi d_e \alpha_e}}$$

Where,

- $\bar{q}_l$  is the linear heat transfer.
- $T_i$  is the water temperature.
- $T_e$  is the exterior temperature, i.e. ambient temperature.
- $D_i$  is the interior diameter of the pipe.
- $D_e$  is the exterior diameter of the pipe.
- $\lambda_{st}$  is the thermal conductivity of steel of which the pipe is made of.
- $\alpha_i, \alpha_e$  are the heat convection coefficients.

$\alpha_i$  and  $\alpha_e$  are calculated using the following relation:

$$\alpha = \frac{Nu \cdot \lambda}{l}$$

Where:

- Nu is the Nusselts number.
- $\lambda$  is the thermal conductivity coefficient.
- L is the length of the pipe.

Nu can be calculated using the following equation:

$$Nu = 0.135(Gr \times Pr)^{0.33}$$

Where:

- Gr is Grashof number
- Pr is Prandt number

Where Gr is calculated as follows:

$$G_r = \frac{g \cdot l^3 \cdot \beta(t_1 - t_2)}{\nu^2}$$

Where:

- $g$  is the gravitational acceleration.
- $L$  is the length of the pipe.
- $\beta$  is the inverse of the average temperature in K.
- $\nu$  is the cinematic viscosity.

$$\beta = \frac{1}{T_m + 273.15}; T_m = \frac{t_1 + t_2}{2}$$

Given,

Term	Symbol	Value	Unit
Exterior diameter	$d_e$	0.16	m
Interior diameter	$d_i$	0.14	m
Ambient temperature	$T_e$	25	°C
Water temperature	$T_i$	70	°C
Interior wall pipe temperature	$T_{pi}$	67	°C
External wall pipe temperature	$T_{pe}$	60	°C
Thermal conductivity of steel	$\lambda_{st}$	53	W/mK
Thermal conductivity of water at 70°C	$\lambda_{water}$	0.65	W/mK
Thermal conductivity of air at 25°C	$\lambda_{air}$	0.025	W/mK
Kinematic viscosity of air at 25°C	$\nu_{air}$	$15.5 \times 10^{-6}$	m <sup>2</sup> /s
Kinematic viscosity of water at 70°C	$\nu_{water}$	$0.47 \times 10^{-6}$	m <sup>2</sup> /s
Prandtl's number for air at 25°C	$Pr$	0.69	-
Prandtl's number for water at 70°C	$Pr$	2.99	-

Table 10. Given Values.

First case:

Convective heat transfer between the water and the interior pipe wall.

$$T_m = \frac{70 + 67}{2} = 68.5$$

$$\beta = \frac{1}{T_m + 273.15} = \frac{1}{68.5 + 273.15} = 0.002$$

$$G_r = \frac{9.8 \cdot 0.14^3 \cdot 0.002 (70 - 67)}{(0.47 \times 10^{-6})^2} = 7 \times 10^8$$

$$Nu = 0.135 (7 \times 10^8 \cdot 2.99)^{1/3} = 84.4$$

$$\alpha_i = \frac{Nu \cdot \lambda}{l} = \frac{84.4 \cdot 0.65}{0.14} = 391.8 \text{ W/m}^2\text{K}$$

Second case:

Convective heat transfer between the exterior pipe wall and the air.

$$T_m = \frac{60 + 25}{2} = 42.5$$

$$\beta = \frac{1}{T_m + 273.15} = \frac{1}{42.5 + 273.15} = 0.003$$

$$G_r = \frac{9.8 \cdot 0.16^3 \cdot 0.003 (60 - 25)}{(15.5 \times 10^{-6})^2} = 2.1 \times 10^7$$

$$Nu = 0.135 (2.1 \times 10^7 \cdot 0.69)^{1/3} = 18.99$$

$$\alpha_i = \frac{Nu \cdot \lambda}{l} = \frac{18.99 \cdot 0.025}{0.16} = 2.96 \text{ W/m}^2\text{K}$$

Then,  $\bar{q}_l$  can be calculated as follows:

$$\bar{q}_l = \frac{70 - 25}{\frac{1}{\pi \cdot 0.14 \cdot 391.8} + \frac{1}{2\pi \cdot 53} \ln \frac{0.16}{0.14} + \frac{1}{\pi \cdot 0.16 \cdot 2.96}} = 60 \text{ W/m}$$

Knowing the value of  $\bar{q}_l$ , we can calculate the total length of steel pipes needed using the following relation:

$$Q = \bar{q}_l \cdot l$$

$$\text{Thus, } l = \frac{Q}{\bar{q}_l} = \frac{158,634}{60} = 2,643 \text{ m}$$

#### 2.4. Pressure loss

Pressure losses or drops of fluids passing through pipes usually occur for various reasons. Sometimes the fluid loses pressure throughout the installation and sometimes it gains pressure due to differences in elevation between the end and the start of the pipe.

Some of the reasons behind pressure loss are mentioned below:

- Friction between the fluid passing and the pipe wall.
- Friction between the layers of the fluid itself.
- Elevation differences.
- Existence of pipe fittings, bends, narrowing, and elbows.

It is essential to calculate the pressure loss throughout the system because the size of the chosen pump should be able to cover the pressure losses along the installation.

#### Flow Rate

The flow rate is calculated using the following relation:

$$\text{Flow rate} = \frac{1}{4} \cdot \pi \cdot d^2 \cdot V = 0.01 \text{ m}^3/\text{s}$$

where:

- D is the inner diameter of the pipe.
- V is the velocity of the fluid passing through the pipe, in this case the velocity of hot water is estimated to be around 1 m/s.

#### Reynold's number

$$Re = \frac{V \cdot d}{\nu}$$

Where:

- $V$  is the velocity of the fluid, 1 m/s.
- $D$  is the internal diameter.
- $\nu$  is kinematic viscosity of water at 70°C.

$Re = 0.29 \times 10^6 > 2,300$ ; which indicates that in this case we have a turbulent flow.

To determine the friction coefficient  $\lambda$ , we have to use the calculation relation for turbulent flow considering the case of a smooth pipe as follows:

According to Filonenko's formula[x],

$$\begin{aligned}\lambda &= (1.82 \log Re - 1.64)^{-2} \\ &= (1.82 \log (0.29 \times 10^6) - 1.64)^{-2} \\ &= 0.014\end{aligned}$$

Linear pressure loss or head loss

$$h_l = \lambda \frac{l}{d} \cdot \frac{v^2}{2g}$$

Where:

- $\lambda$  is the friction coefficient calculated above.
- $l$  is the length of the pipe.
- $d$  is the internal diameter of the pipe.
- $v$  is the velocity of the fluid, in this case water, passing through the pipe.
- $g$  is the gravitational acceleration.

$$\begin{aligned}h_l &= 0.014 \cdot \frac{2,400}{0.14} \cdot \frac{1^2}{2 \cdot 9.8} \\ &= 12.2 \text{ m} = 1.196 \text{ bar}\end{aligned}$$

Local pressure loss

$$h_s = \Sigma \xi \frac{v^2}{2g}$$

Where:

- $\xi$  is the local pressure loss chosen to be equal to 0.138. [x]
- $v$  is the fluid velocity.
- $g$  is the gravitational acceleration.



$$\begin{aligned}h_s &= 1000 \cdot 0.138 \cdot \frac{1^2}{2 \cdot 9.8} \\ &= 7 \text{ m} = 0.68 \text{ bar}\end{aligned}$$

$$\begin{aligned}\text{Total pressure loss} &= \text{linear pressure loss} + \text{local pressure loss} \\ &= 1.196 + 0.68 \\ &= 1.876 \text{ bar}\end{aligned}$$

Which implies that the adequate pump pressure to recover the pressure losses in the system is that of 2 bar.

## 2.5. Sizing the buffer tank

The buffer or reservoir is considered to have (3...5) times the debit of the pump, which means that the reservoir should be able to feed the pump with fluid independently up to almost 4-5 minutes until it dries out.

In this case:

$$\text{Flow rate} = 0.01 \text{ m}^3/\text{s} = 600 \text{ l/min}$$

So, the buffer tank should be 5 times the flow rate =  $5 \times 600 = 3,000 \text{ l}$

## 2.6. Yearly amount of wood chips

The yearly amount of wood chips is based on 3 important factors:

- The yearly head demand measured in kwh/year
- The heating value of woodchips measured in kwh/kg, in this case, the woodchips are considered to be of 30% moisture [x]
- The efficiency of the boiler %

$$\begin{aligned}\text{Wood chips (kg/year)} &= \frac{E/\text{year}}{H'(M)30 \cdot Ef\%} \\ &= \frac{278,170}{3.4 \cdot 80\%} \\ &= 102,268 \text{ kg/year} = 102 \text{ tons/year}\end{aligned}$$



# Budget and Economic Analysis



**Compilation of case studies of applying renewable energies to local  
development transnationally implemented**



Co-funded by the  
Erasmus+ Programme  
of the European Union



Denomination	Units	Cost (€)	Total Cost (€)
Boiler GILLES HPK-RA 160 kW	1	€ 20,000.00	€ 20,000.00
Steel pipes (1 meter)	2,400	€ 8.28	€ 19,875.00
Expansion vessel (400 l)	1	€ 680.00	€ 680.00
Buffer tank (3000 l)	1	€ 2,300.00	€ 2,300.00
Accessories	NA	€ 1,500.00	€ 1,500.00
Installation	NA	€ 1,000.00	€ 1,000.00
Maintenance	1	€ 200.00	€ 200.00
Check valve	3	€ 150.00	€ 450.00
Water pump (4 bar)	1	€ 230.00	€ 230.00
Transport fees	NA	€ 620.00	€ 620.00
Auger	1	€ 2,440.00	€ 2,440.00
TOTAL GREENHOUSE HEATING			€ 49,295.00
MATERIAL EXECUTION BUDGET			€ 49,295.00
13% OF GENERAL EXPENSES			€ 6,408.35
6% OF INDUSTRIAL BENEFITS			€ 2,957.70
SUBTOTAL			€ 58,661.05
21% TVA			€ 12,318.82
<b>TOTAL BUDGET</b>			<b>€ 70,979.87</b>

Considerations	
Capital cost	€ 70,979.87
Estimated energy production	797,440 kW
Annual energy loss	0,5%
Pellet cost	0,04€/kW
Gasoil cost	0,059€/kW
Wood chip annual increase	0,4%
Gasoil annual increase	3,5%
Discount rate	4,02%
O&M cost	€ 456
Investment period	20 years
Grant	35%



Year	Energy Production (kWh/year)	Wood chip cost (€/year)	Gasoil cost (€/year)	Estimated savings (€/year)	O&M cost (€)	Cash flow (€)	Cumulative cash flow (€)
0							
1	797,440.00	31,897.60	47,048.96	15,151.36	456.00	14,695.36	14,695.36
2	793,452.80	31,865.62	48,452.19	16,587.13	456.00	16,131.13	30,826.49
3	789,485.50	31,832.05	51,316.55	19,484.50	456.00	19,028.50	49,854.99
4	785,538.00	31,798.50	52,631.05	20,832.50	456.00	20,376.50	70,231.49
5	781,610.30	31,764.60	53,931.10	22,166.50	456.00	21,710.50	91,941.99
6	777,702.20	31,730.24	55,216.80	23,486.56	456.00	23,030.56	114,972.55
7	773,813.68	31,695.40	56,488.39	24,792.99	456.00	24,336.99	139,309.54
8	769,944.60	31,660.12	57,745.80	26,085.68	456.00	25,629.68	164,939.22
9	766,094.87	31,624.39	58,989.30	27,364.91	456.00	26,908.91	191,848.13
10	762,264.39	31,588.20	60,218.80	28,630.60	456.00	28,174.60	220,022.73
11	758,453.06	31,551.64	61,434.69	29,883.05	456.00	29,467.05	249,489.78
12	754,660.79	31,514.60	62,636.80	31,122.20	456.00	30,666.20	280,155.98
13	750,887.48	31,477.20	63,825.40	32,348.20	456.00	31,892.20	312,048.18
14	747,133.04	31,439.30	65,000.00	33,560.70	456.00	33,104.70	345,152.88
15	743,397.37	31,401.10	66,162.30	34,761.20	456.00	34,305.20	379,458.08
16	739,677.38	31,362.30	67,310.60	35,948.30	456.00	35,492.30	414,950.38
17	735,978.90	31,323.26	68,446.03	37,122.70	456.00	36,666.70	451,617.08
18	732,299.00	31,283.81	69,568.40	38,284.59	456.00	37,828.59	489,445.67
19	728,637.50	31,243.97	70,677.83	39,433.86	456.00	38,977.86	528,423.53
20	724,994.30	31,203.75	71,774.40	40,570.65	456.00	40,114.65	568,538.18

Year	Payback (€)	Payback with grant (€)	NPV (€)	NPV with grant (€)
0				
1	(56,284.51)	(31,441.56)	(56,852.43)	(32,009.40)
2	(40,152.38)	(15,310.43)	(41,943.80)	(17,100.70)
3	(21,124.88)	3,718.07	(25,029.57)	(186.47)
4	(748.38)	24,094.57	(7,613.75)	17,229.34
5	20,962.12	45,805.07	10,225.60	35,068.60
6	43,992.68	68,835.63	28,417.19	53,260.10
7	68,329.67	93,172.62	46,896.30	71,739.20
8	93,959.35	118,802.30	65,604.00	90,446.20
9	120,868.26	145,711.21	84,487.40	109,330.20
10	149,042.86	173,885.81	103,485.70	128,328.60
11	178,469.91	203,312.86	122,569.39	147,412.20
12	209,136.11	233,979.06	141,687.96	166,530.70
13	241,028.31	265,871.26	160,796.52	185,639.20
14	274,133.01	298,975.96	179,866.04	204,708.70
15	308,438.21	333,281.16	198,861.16	223,703.80
16	343,930.51	368,773.46	217,760.14	242,602.70
17	380,597.21	405,440.16	236,525.08	261,367.60
18	418,425.80	443,268.75	255,141.51	279,984.00
19	457,403.66	482,246.61	273,579.47	298,421.90
20	497,518.31	522,361.26	291,821.69	316,664.10



Payback	4 years
Payback with grant	2 years
NPV	4 years
NPV with grant	3 years
IRR	4 years
IRR with grant	3 years



**Compilation of case studies of applying renewable energies to local  
development transnationally implemented**



Co-funded by the  
Erasmus+ Programme  
of the European Union





# Project Plans





**Compilation of case studies of applying renewable energies to local  
development transnationally implemented**



Co-funded by the  
Erasmus+ Programme  
of the European Union



## I. Greenhouse

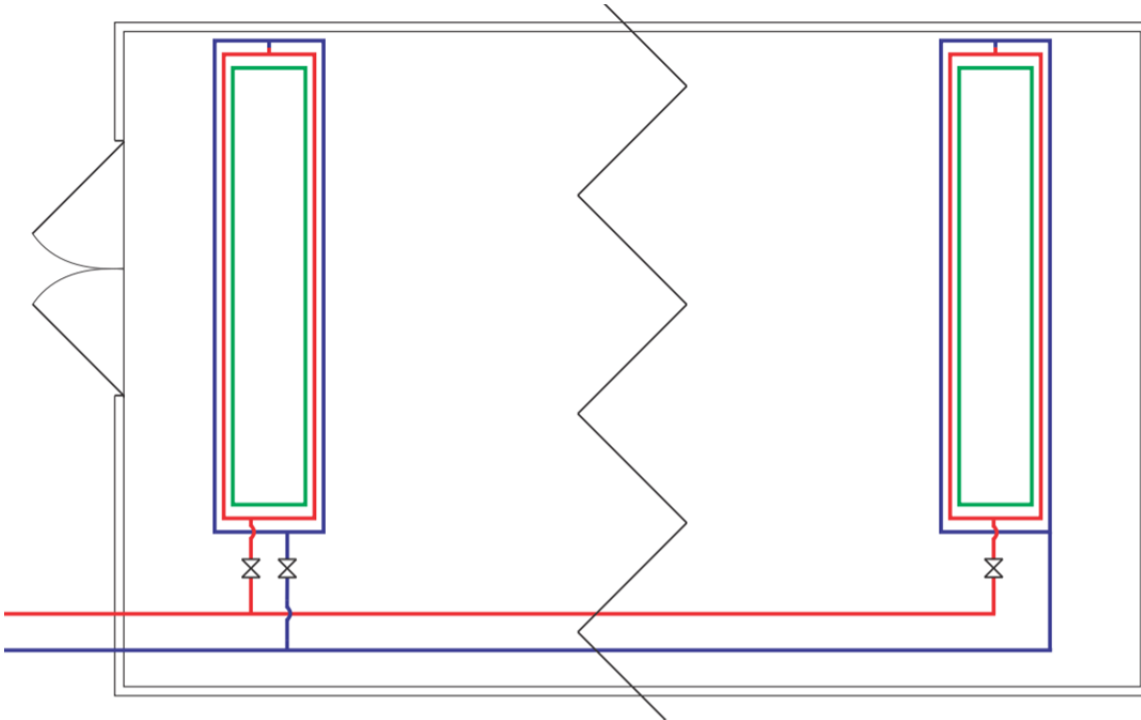

## II. Boiler

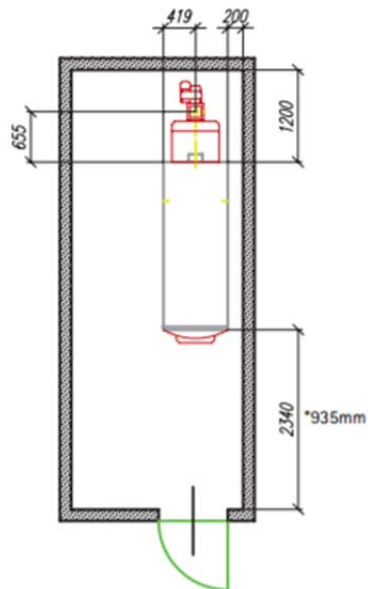



**Compilation of case studies of applying renewable energies to local  
development transnationally implemented**



Co-funded by the  
Erasmus+ Programme  
of the European Union





**Compilation of case studies of applying renewable energies to local  
development transnationally implemented**



Co-funded by the  
Erasmus+ Programme  
of the European Union

REPORT OF THE CASE STUDY ON RENEWABLE ENERGIES TO LOCAL  
DEVELOPMENT TRANSNATIONALLY IMPLEMENTED

# Differences between 2 PV systems in irrigation

Corneliu Zediu

”Vasile Alecsandri” University of Bacau

[zediucorneliu@gmail.com](mailto:zediucorneliu@gmail.com)

Case study tutor: Lluís Monjo

Renewable energies tutor: Jose Segarra Murria - UMANS

Rural development tutor: Vicent Querol

English tutor: Csaba Szűcs

Professional supervisor: Zsuzsanna Kray

UMANS – Urbanisme i Medi Ambient Nebot i Segarra

La Vall d’Uixó, March-April 2017



**Compilation of case studies of applying renewable energies to local development transnationally implemented**



Co-funded by the  
Erasmus+ Programme  
of the European Union





## Contents of the project

1. Introduction to the project.....	7
1.1. Objectives of the project	9
1.2. scope	9
1.3. location of the project	10
1.4. precedents	11
1.5. state-of-art in the problem domain	13
1.6. design systems to be compared	23
1.7. design of the pv array	27
1.8. the impact of the project on rural development	28
1.8.1. Environmental impact	30
1.8.2. Social and rural impact	32
1.9. conclusions	34
1.10. references	35
2. Calculations and design .....	40
2.1. energy demand, system losses and performance rate	40
2.2. installation sizing and selection of the equipment	44
3. Economical aspects of the project.....	55
3.1. budget of the installation	56
3.2. payback, IRR and NPV	59
4. Project Plans .....	65





**Compilation of case studies of applying renewable energies to local development transnationally implemented**



Co-funded by the  
Erasmus+ Programme  
of the European Union





# Memory of the project



**Compilation of case studies of applying renewable energies to local  
development transnationally implemented**



Co-funded by the  
Erasmus+ Programme  
of the European Union



## 1. Introduction to the Project

For centuries people have looked for ways to improve their life starting with the fundamental needs. Agriculture, then as now, is the biggest provider of our food and raw materials for industries. However, agriculture depends on many factors such as the quality of the seeds, mineral in the soil, geographical position, as well as the quantity of water and climate. The last two are interdependent because water can be provided from rivers (Figure 1) in the area as well as from precipitation.

Another option to provide water for irrigation is to install a special pump in the soil through the groundwater powered by photovoltaic panels (Figure 2). This system can be used as the main system of irrigation as well as a backup system. Although renewable energy (RE) makes a low impact on the environment, a farmer or a company may benefit from other important advantages of it like: energy independence, sustainability or low cost of energy.



Figure 1. Irrigation from river <sup>[1]</sup>

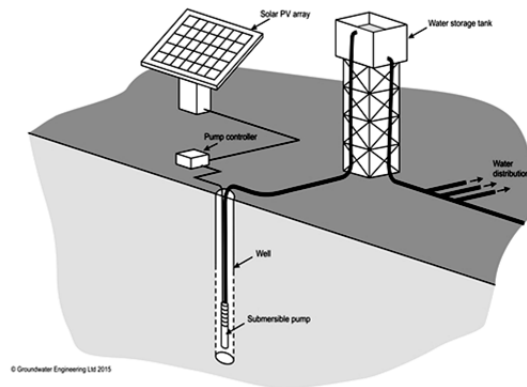

Figure 2. Off-grid irrigation system <sup>[2]</sup>

Renewable energy has a great impact on rural areas. Besides maintaining the energy requirements for private contractors, RE can fulfil the need of an entire rural society:

- Low-price energy – even though the initial price is substantial, in the medium and long time terms, the price of renewable energy is low and sustainable.
- Economic growth – by decreasing the price of energy, people and companies have more capital for spending on their needs, which can lead to a better economic cycle.
- Energy independence – RE can be installed in places where connection to the grid represents technological difficulties or high construction costs.
- Job opportunities – this can happen directly by creating jobs in the field or indirectly by decreasing the cost of energy of the companies resulting in more capital for human resources
- Modern design – equipment of renewable energy sources has a futuristic design and gives a modern touch to rural environment.
- Young people – with the benefits of increased job opportunities and life stability, young people tend less to move in different locations.
- Variety for personal/ industrial use – it depends on the technology, the profile of the customer can change depending on the need.

Even more, the benefits of RE can be noticed on a worldwide scale. For example, in 2015 the International Renewable Energy Agency (IRENA) has recorded that “8.1 million people were hired in renewable energy industry from which almost 2.8 million jobs were in solar energy (Figures 3 and 4) all around the globe with an increasing trend.”<sup>[3]</sup>

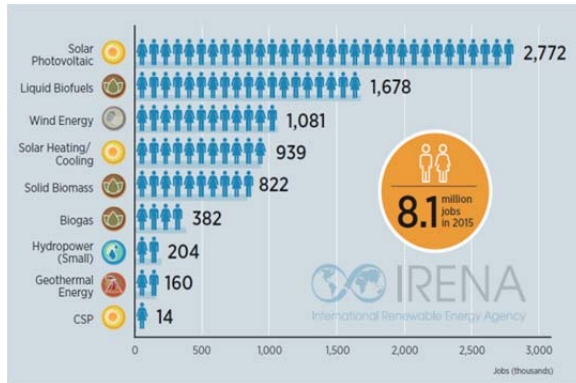

Figure 3. Renewable Energy Employment by Technology<sup>[3]</sup>

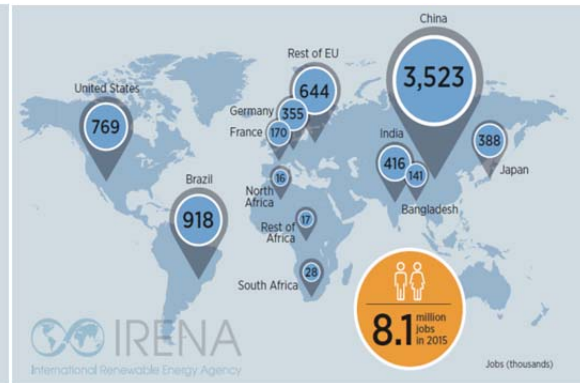

Figure 4. Renewable Energy Employment in Selected Countries and Regions<sup>[3]</sup>

Another important factor that awakes the interest for alternative energy sources is given by limited fossil fuel resources. Therefore, sustainability has become a big part of research for the new technologies. The emergence of these technologies is built on principles gained over time. In consequence we start harvesting energy from endless sources of natural energy. The interest in sustainable energy can be seen in international statistics. For example, from 2014 to 2015 it has registered in amount of +3.5 % of RE power (Figure 5 and 6).<sup>[5]</sup>

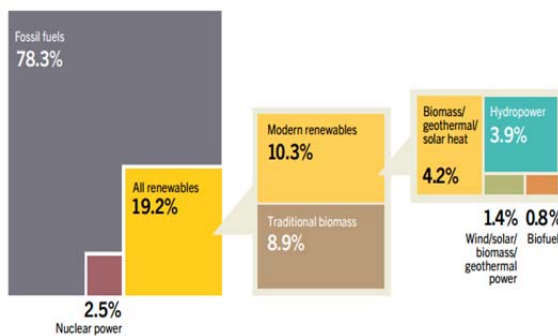

Figure 5. Estimated Renewable Energy Share of Global Final Energy Consumption, 2014<sup>[5]</sup>

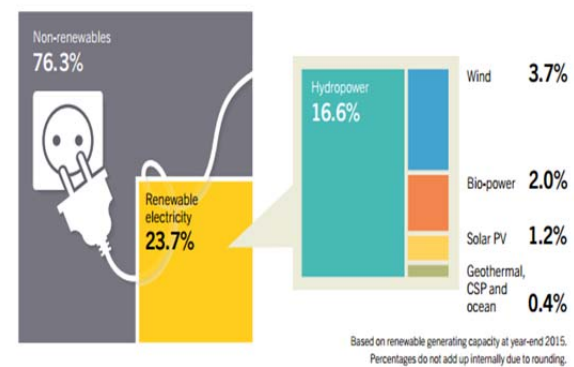

Figure 6. Estimated Renewable Energy Share of Global Electricity Production, End-2015<sup>[5]</sup>

To define the RE industry, governments have set up laws and directives in order to facilitate growth. The legislation is different in each country but they are align with the International Conferences on Environment and Renewable Energy (ICERE), World Future Energy Summit (WFES), EU Directives (e.g. Directive 2009/28/EC of the European Parliament and of the Council of 23 April 2009 on the promotion of the use of energy from renewable sources and amending and subsequently repealing Directives 2001/77/EC and 2003/30/EC).<sup>[4]</sup>

### 1.1. Objectives of the project

One of the objectives of the project is to ensure the information needed to design a photovoltaic system that will produce enough energy for an underground pump. The pump has to irrigate 75.660 m<sup>2</sup> of agriculture land as shown in Table 1. The calculation will be related to the summer month being the main demand.

Month	Mar.	Apr.	May	June	July	Aug.	Sept.	Oct.	Nov.
Hours	3	4	4	5	5	5	4	3	2

Table 1. Irrigation hours per day

On the other hand, the social impact has to be taken into account. The introduction of any new technologies in the rural environment has to protect and preserve the ecosystems of the areas as well as the traditions and habits. In the context of the modern lifestyle and the evolution of the society, RE can fulfil the socio-economic aspects.

### 1.2. Scope

According to a European Union (EU) report from 2012, “More than half (51.3 %) of the EU’s land area is within regions classified as being predominantly rural”. However, the population located in those areas represent just 22.3 % of EU-27 population with 112.1 million people”<sup>[6]</sup>. In data registered in 2015, after Croatia’s accession to the EU (2013), the distribution of urban-rural population has changed as shown in Figure 7 and Figure 8.

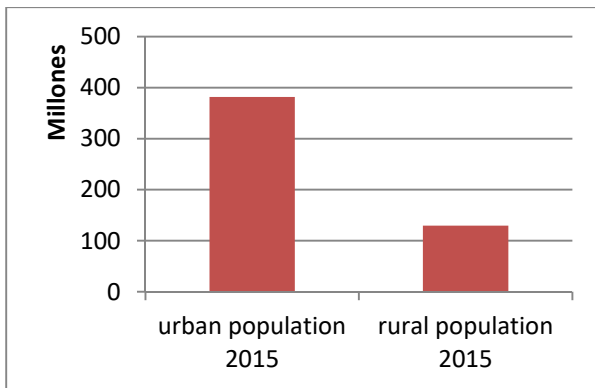

Figure 7. Urban – Rural population<sup>[7]</sup>

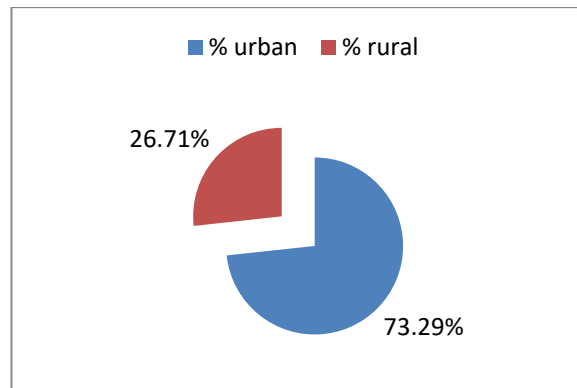

Figure 8. Urban – Rural percentage<sup>[7]</sup>

Within this context were rural areas which represent half of EU surface and include just one fourth of the population, this project aims to design one type of system that may improve life conditions for the habitants. This initiative came as a result of many researches that showed the benefits of a well-developed province.

According to the Renewable Energy to Rural Development Summary (Brief for Policy Makers), RE offers to rural areas:

- Affordable and sustainable energy that triggers the economy;
- Development of new income sources as a result of innovation of new products;
- Expansion of businesses thanks to technological advancement leading to new jobs for entire population;

- Strengthened tax base that comes with improvement of public services within the possibility of a development plan of the area;
- Growing population as a result of better life condition and determination of young people not to migrate to big cities. [8]

### 1.3. Location of the project

The location of the project is situated near to a town named Jérica (in Valencian Xèrica) in Castellón province of Valencian Community, Spain. (39°54' N 00°34' W) presented in Figure 9. In the 2009 census, Jérica registered 1703 habitants. The official language spoken by the citizens is Spanish and also the language spoken by most of the people in the region, "Valencià". [9]



Figure 9. The location of Jérica [10]

The municipality has an area of 78.30 km<sup>2</sup>. It is crossed by the river Palancia, and an area in the south is part of the Calderona mountain range. The town centre is located at a height of 523 m, on a rocky promontory along the Palancia river channel. The precipice valley is very difficult to access and therefore, the population has settled in the opposite direction, along the slope of the hill. [9]

The first proves of actual settlements originate from the XI century in period of Muslims but also there are evidences of human activities from Neolithic period. Iberians and Romans have left proves of their presence in Jérica's history.

One of the challenges of the project is to introduce modern technologies in a traditional environment without disturbing the landscape, the culture and the social life of the habitants.

The climate of Jérica is classified as "warm-temperate subtropical climate" or after Köppen-Geiger system as Csa. With an average temperature of 14,5 °C this climate behaviour is given by the presence of the mountains and the Mediterranean Sea within the influences of geographical position. It also offers an average of 2689 hours of sunshine with 75 clear days/ year. The evolution of the sun during the year can be seen in the in following figures.

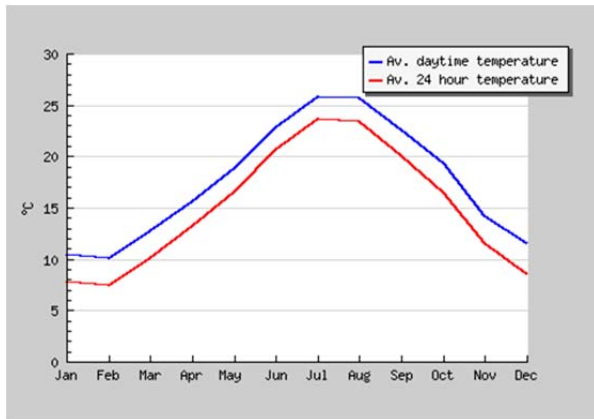

Figure 10. Average daytime temperatures in location of the project<sup>[11]</sup>

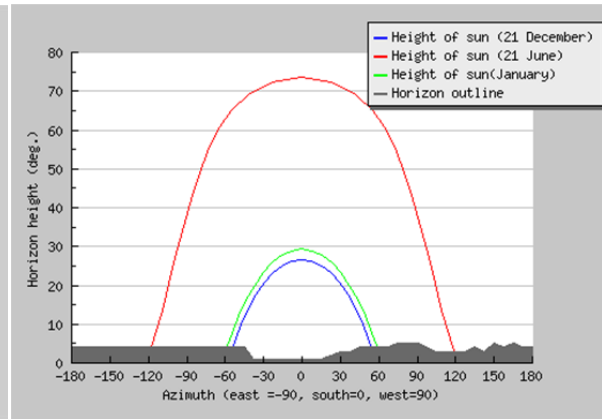

Figure 11. Height of the sun on the horizon outline<sup>[12]</sup>

For the particular case, the months evaluated are June, July and August. For these months, the official monthly average values of temperature, clear/ cloudy/ rainy/ stormy days and hours of sunshine are presented in Table 2.

Month	T	TM	Tm	R	H	DR	DT	DD	I
June	22.5	27.3	17.6	19	63	2.8	2.7	8.4	296
July	25.3	30	20.6	9	64	1.4	2.1	11.7	329
August	25.6	30.3	20.9	24	66	2.4	3.9	7.9	290

Table 2. Monthly average weather values<sup>[13]</sup>

- T Monthly average temperatures (°C)
- TM Monthly average of maximum daily temperatures (°C)
- Tm Monthly average of minimum daily temperatures (°C)
- R Monthly average rainfall (mm)
- H Average relative humidity (%)
- DR Monthly average number of rainfall days equal or greater to 1mm
- DT Monthly average number of stormy days
- DD Monthly average number of cloudless days
- I Monthly average number of hours of sunshine

This characteristic offers good conditions for the primary section of the economy (direct use of natural resources; e.g.: agriculture, forestry, fishing, and mining).

Traditionally, the primary sector has been of great importance in the Jericano economy. The agriculture of arid land has been important, producing *olive*, *carob* and *almond* crops. Recently, rural tourism has been an important sector relying on the medieval market.<sup>[14]</sup>

The placement of the installation is designed to be situated at a distance of 5-6 km away from the city, in an agricultural area of 75.660 m<sup>2</sup> designated to harvest 30 ha almond and 3 ha lavender for commercial purpose (selling the raw and derived products such as oil and essence).



### 1.4. Precedents

Photovoltaic panels are used to provide energy in rural environment for irrigation systems in many types of installations but all of them follow the principles (Figure 12: A & B). Mainly, the differences are made by the water sources, requirements needed by the water pump (power, flow, pressure) and the way of distribution of the power. Often, a generator is used as a back-up system in case of bad weather condition or during the maintenance of the PV-system.

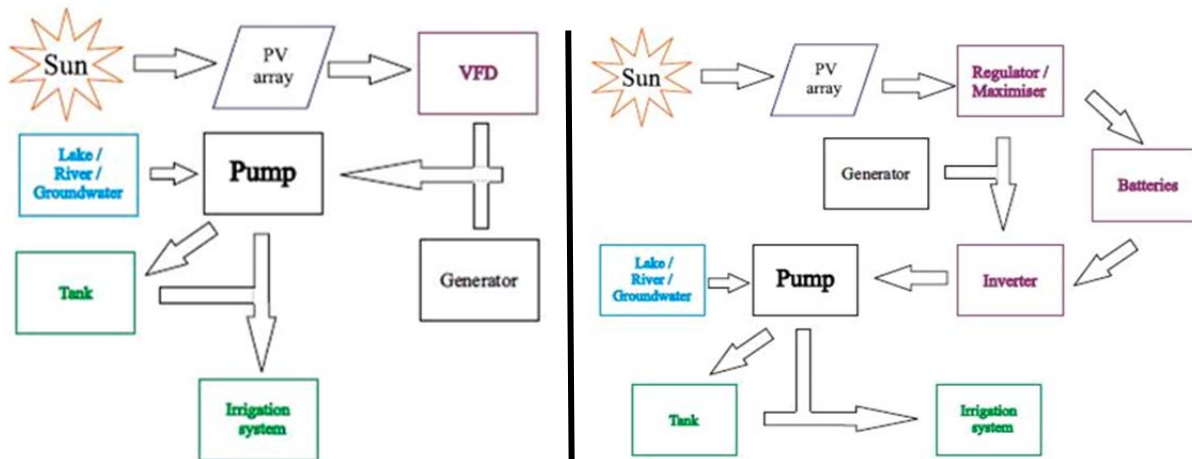

Figure 12-A. Irrigation system with VFD

Figure 12-B. Irrigation system with batteries

To choose the most efficient system of irrigation, a technological and an environmental analysis is required. Starting from the amount of water (flow and pressure) needed, a water pump is chosen as in the following case (project made by Heliotec 2006 S.L. a Spanish SME from Castellón province).<sup>[15]</sup>

A project situated in Quargla (Argelia) had to provide 1.000 m<sup>3</sup> of water each day during the months of June, July and August from a depth of 120 m. The selection of the pump was made according to these requirements. As a result, a hydraulic pump of 125 CV – 92 kW, 380-415 V / 50 Hz; 460 V / 60 Hz was chosen.<sup>[15]</sup>

Analysing monthly radiation levels for 2 different angles (a – 0° and b – 30° ,Figure 13), average hours of radiation per month (Figure 14) and production curve for one kW system (Figure 15), the company designed a PV array for 27 kW compound by 90 modules with peak of 300 Wp organized in 6 parallel lines compound in series of 16'th PV panels.<sup>[15]</sup>

	Daily radiation [kWh/m <sup>2</sup> /day]	Days in month	Monthly radiation [kWh/m <sup>2</sup> /month]
January	3,61	31,00	112
February	4,66	28,00	131
March	6,11	31,00	189
April	6,75	30,00	202
May	7,33	31,00	227
June	7,89	30,00	237
July	7,78	31,00	241
August	7,14	31,00	221
September	5,74	30,00	172
October	4,91	31,00	152
November	3,97	30,00	119
December	3,28	31,00	102
ANNUAL	5,77	365,00	2.110

*a*

	Daily radiation [KWh/m <sup>2</sup> /day]	Days in month	Monthly radiation [kWh/m <sup>2</sup> /month]
January	5,61	31	174
February	6,45	28	181
March	7,23	31	224
April	6,99	30	210
May	6,88	31	213
June	7,05	30	211
July	7,11	31	220
August	7,11	31	220
September	6,42	30	193
October	6,33	31	196
November	5,94	30	178
December	5,27	31	163
ANNUAL	6,53	365	2384

*b*

Figure 13. Radiation per month on angle<sup>[15]</sup>

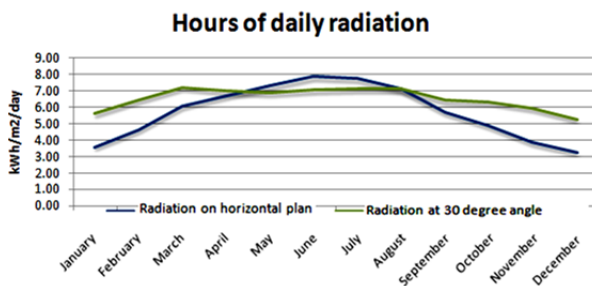

Figure 14. Hours of daily radiation<sup>[15]</sup>

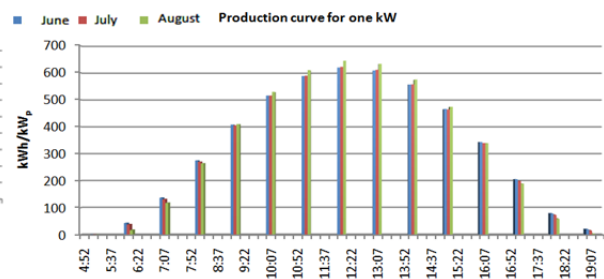

Figure 15. Production curve for one kW system<sup>[15]</sup>

This system is design to work through a variable frequency driver (VFD – check 1.5 E) that provides the capacity of running at different speeds of the engine offering accurate control.<sup>[15]</sup>

### 1.5. State-of-art in the problem domain

The challenging part of the project is to provide a more efficient system to provide energy for the existing irrigation system. The existing installation consists of a generator (Figure 16 - CTM-60 L, Carod) as source of energy for the pumps that execute the irrigation as shown in Figure 17.



Figure 16. Generator CTM-60 L, Carod<sup>[16]</sup>

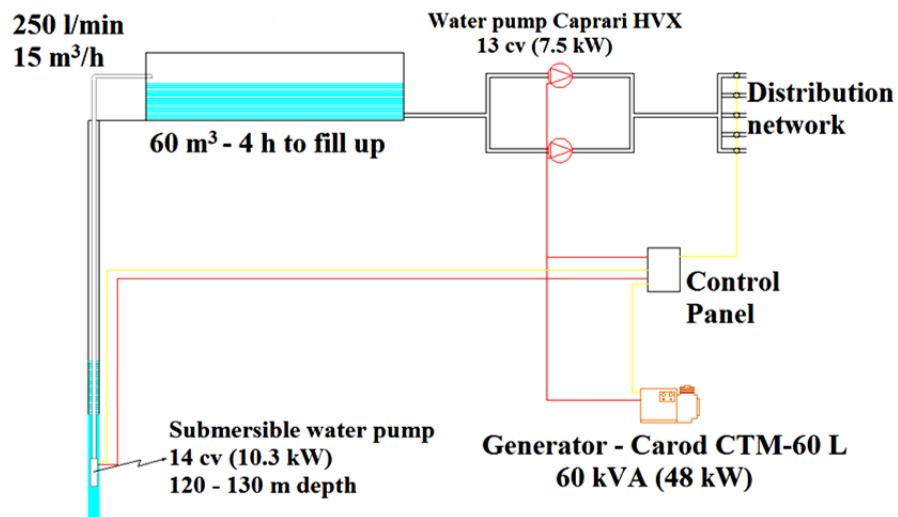

Figure 17. Previous Irrigation system<sup>[17]</sup>

The new system is design to replace the 3 pump with a more efficient pump regarding flow and consumption. The pump will be powered by the photovoltaic system that fits the best in demands of the contractor.

Starting from the power source, the system is a compound of the following:

- A. Solar Radiation
- B. PV panels : PV cells + designated structure
- C. Charge controller : Regulator / MPPT
- D. Battery
- E. PV inverters or Variable frequency driver (VFD)
- F. Loads
- G. Other aspects

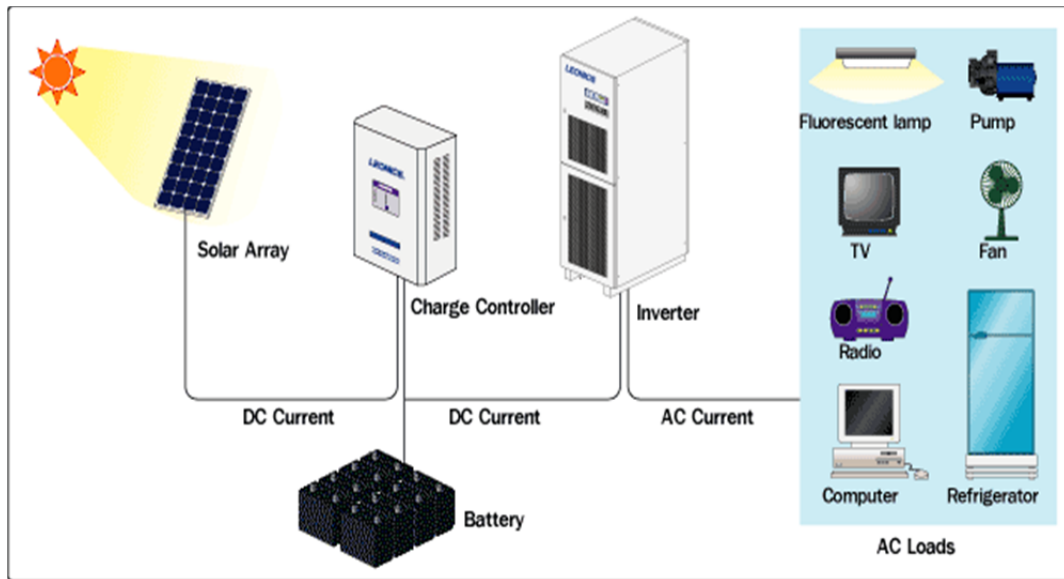

Figure 18. Components of Off-Grid PV System<sup>[18]</sup>

#### A. Solar Radiation.

Solar radiation is the main source of energy that turns into electricity inside photovoltaic cells via photovoltaic effect. This phenomenon occurs when solar radiation photons impact on a semiconductor surface. If the photon hits the semiconductor surface with enough energy, it releases an electron that leaves enough space for the electrons to move and generate an electric current as a consequence.<sup>[19]</sup>

Factors that influence the level of radiation over the PV-panel :

- a. Radiation;
- b. Inclination;
- c. Losses due to shades;
- d. Losses due to dirt;

#### a. Radiation.

Solar radiation is made up of groups of electromagnetic waves with different frequencies and, therefore, different energies. The representation of the energy of radiation according to the wavelength, or the frequency, is known as the spectrum.<sup>[19]</sup>

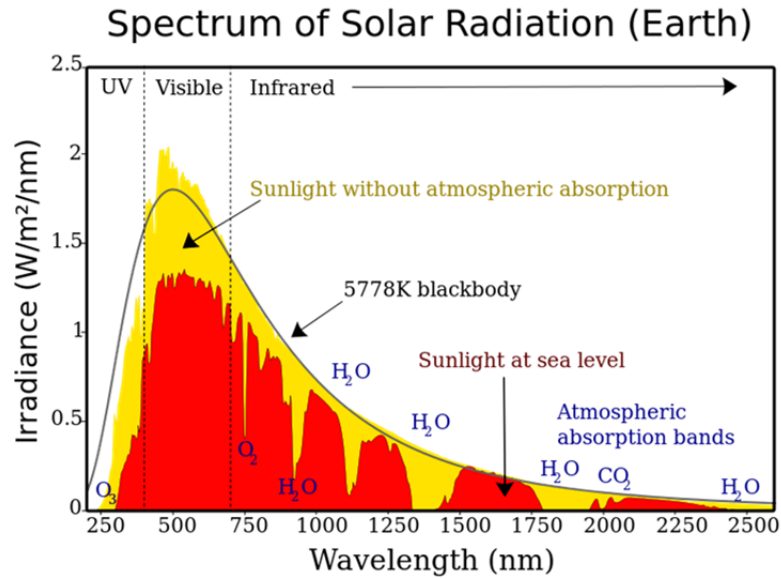

Figure 19. Solar Radiation Spectrum, by Robert A. Rohde <sup>[20]</sup>

From all the spectrum, the radiation that contributes for producing energy within PV panels have values between 390 nm and 750 nm is named as visible range. This type of radiation has the power to interact with materials used in the manufacturing of photovoltaic cells. <sup>[19]</sup>

The quantity of radiation can be different depending on the way of its distribution. Therefore, we have Direct Radiation, Diffuse Radiation and Reflected Radiation (Figure 20).

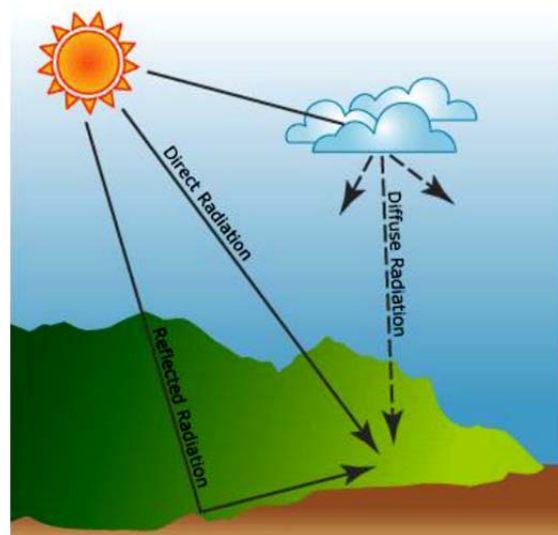

Figure 20. Radiation types World map by SolarGIS <sup>[21]</sup>

Incoming radiation provided by the sun from 1983 to 2005 - in Spain had in average values between 3 and 5 kWh (Figure 21) with a direct radiation between 1.5 and 4.2 kWh (Figure 22).

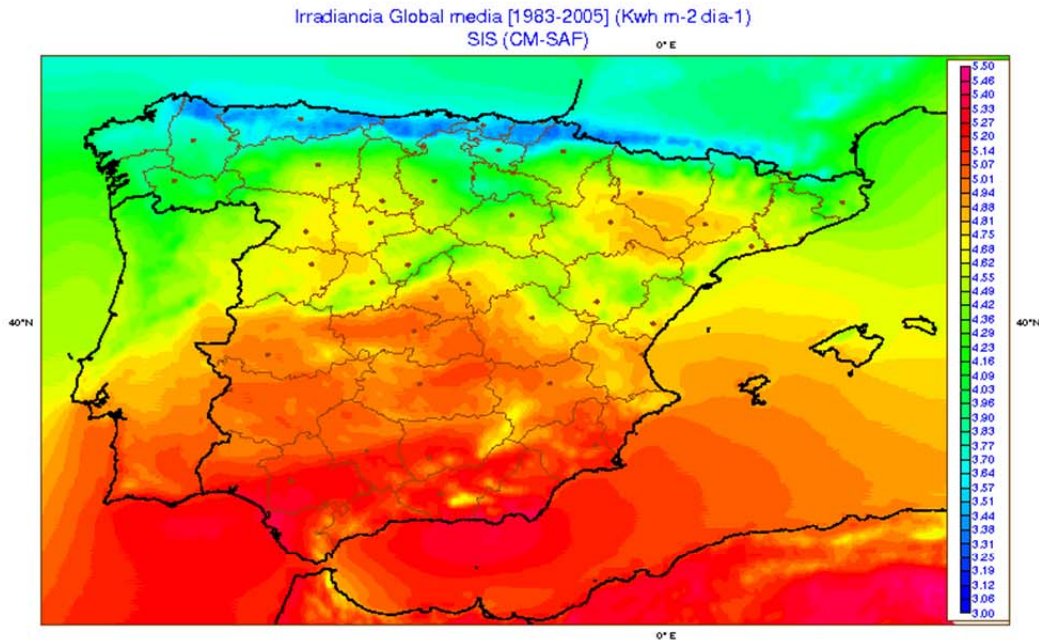

Figure 21. Incoming Radiation – Spain<sup>[22]</sup>

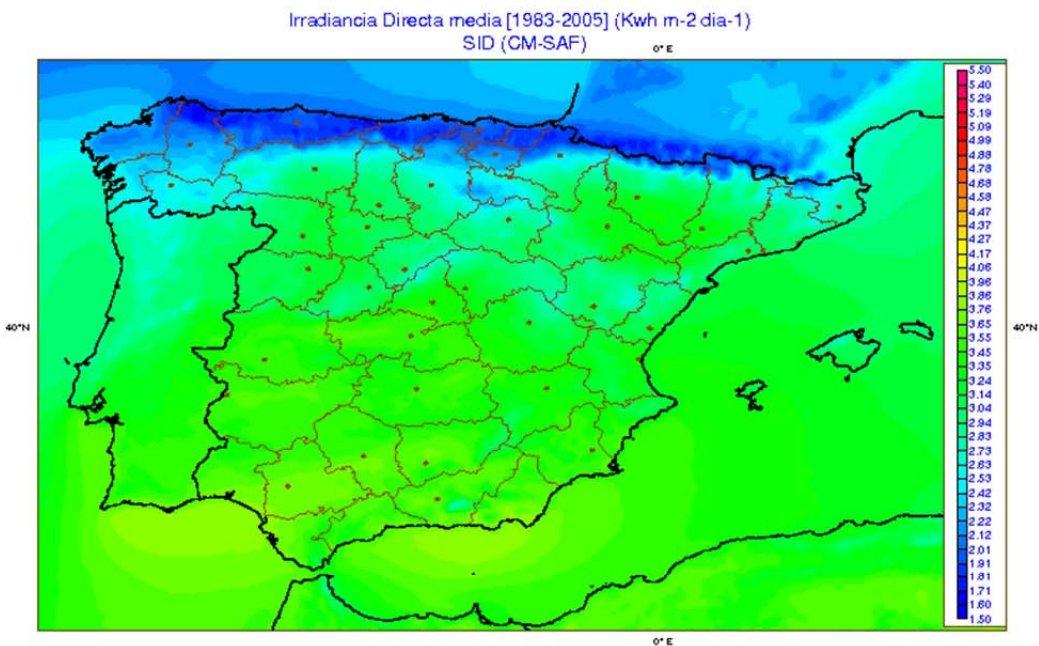

Figure 22. Direct Radiation – Spain<sup>[22]</sup>

Another important factor for radiation level is the “variation of solar energy flow” that includes<sup>[19]</sup>:

- *Geographical sunlight variation* (each surface gets a distinguished quantity of radiation depending on the geographical position);
- *Diurnal light variation*: caused by the rotation of the Earth around its own axis and its trajectory around the Sun. This daily variation produces changes in the solar radiation on a surface throughout the day and the months of the year (Figure 23).”

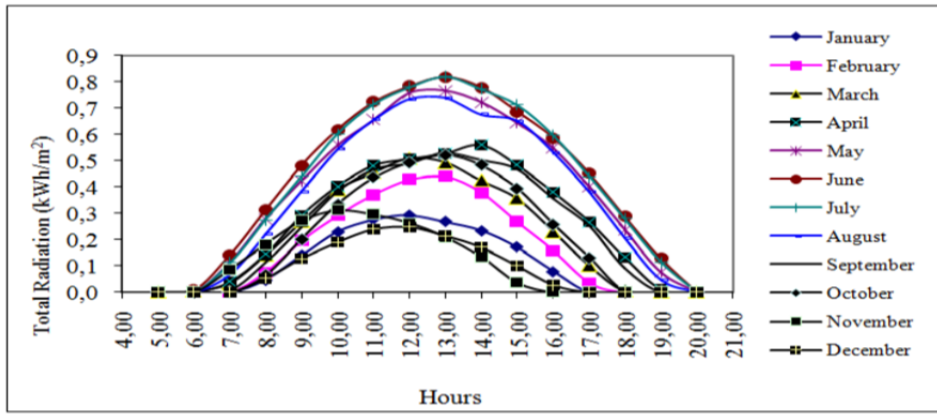

Figure 23. Diurnal Light Variation <sup>[19]</sup>

- *Elevation or altitude.* Surfaces situated at higher altitude above the sea level get a higher quantity of solar radiation because of thinner atmosphere and a shorter distance from the sun.

b. Inclination

Different angles between the surface and the sun can increase or decrease the efficiency of the PV-panels. The proper angle is variable during the day and year because of the continuous movement of the Earth and the Sun. To calculate the angle of the PV modules, there are three different situations that need to be taken into account:

Annual demand:  $\alpha = \phi - 10$  Eq. (1) <sup>[19]</sup>

Summer demand:  $\alpha = \phi - 20$  Eq. (2) <sup>[19]</sup>

Winter demand:  $\alpha = \phi + 10$  Eq. (3) <sup>[19]</sup>

$\alpha = \phi - 20^\circ = 39^\circ - 20^\circ = 19^\circ$  Eq. (4)

$\alpha$  – angle;  $\phi$  – latitude of the location

From practical consideration, the chosen angle is  $\alpha = 20^\circ$  (Figure 24).

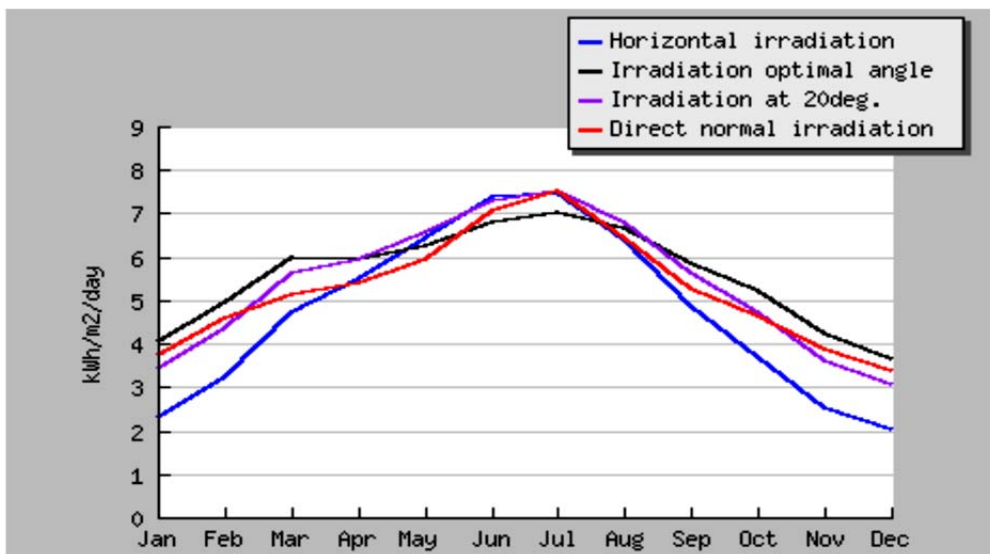

Figure 24. Irradiation by angle for PV Panel - PVGIS-CMSAF

c. Losses caused by shadow

Anything that comes between the Sun and the PV-panel can contribute to decrease the quantity of solar radiation leading to less efficiency. Shades on PV-panels can come from natural sources as clouds and trees but also from artificial sources as buildings, columns and other PV-panels situated too close to one to another.

d. Losses caused by dirt and dust

Photovoltaic systems are affected by dirt and dust because of the weather condition (wind) and placement of the systems (rural or heavy industry areas). Estimated losses in a normal environment are considered to be 5%.

B. PV panels : PV cells + designated structure

Advancement of technologies lead the companies to provide a wide range of photovoltaic cells made with different types of semiconductors:

Name	Material	Efficiency	Observation
Monocrystalline silicon	Same time of silicon crystals	Up to 14-18 %	<ul style="list-style-type: none"> <li>▪ highest efficiency</li> <li>▪ high cost to produce the monocrystals</li> </ul>
Polycrystalline silicon	Different types of silicon crystals	Up to 12-14 %	<ul style="list-style-type: none"> <li>▪ High efficiency for a lower price</li> </ul>
Amorphous silicon / Thin film panel	Non-crystal silicon	≈ 10%	<ul style="list-style-type: none"> <li>▪ cheapest</li> <li>▪ flexible</li> <li>▪ used in curved and irregular surfaces</li> </ul>
CIS and CISG	Copper, indium, selenide and gallium (CISG)	≈ 10%	<ul style="list-style-type: none"> <li>▪ used in thin film modules</li> </ul>
CdTe	Cadmium telluride	≈ 10%	<ul style="list-style-type: none"> <li>▪ used in thin film modules</li> </ul>
Others	Researchers are continuing to develop new technologies that produce electricity using photovoltaic cells.		

Table 3. PV Cells materials

PV cells are assembled on Solar Panels with different sizes and shapes. Most of the traditional PV panels are configured for fixed or mobile (with sun tracking systems) structures.

Fixed structures can be used as coplanar (parallel) structures or with inclination. Depending on the need (solar radiation, placement, costs and governmental regulation), engineers choose the proper structure. Coplanar structures are usually mounted on the roofs with a proper distance to ventilate the structure.





Figure 25. Coplanar PV Panels<sup>[23]</sup>



Figure 26. Inclined PV Panels<sup>[24]</sup>

To raise the efficiency, PV-cells can be assembled on PV panels with a sun tracking system. By changing the angle between the Sun and the surface (Figure 27), the cells can absorb more solar radiation intensifying the productivity by up to 40 %.

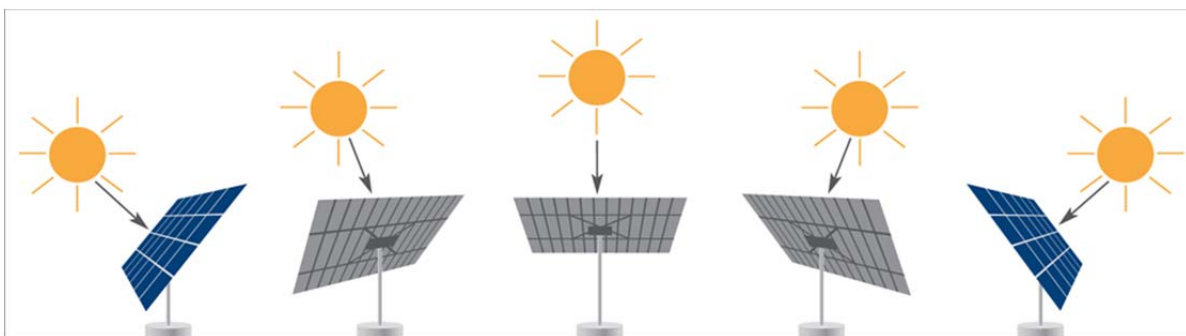

Figure 27. Sun tracking system<sup>[25]</sup>

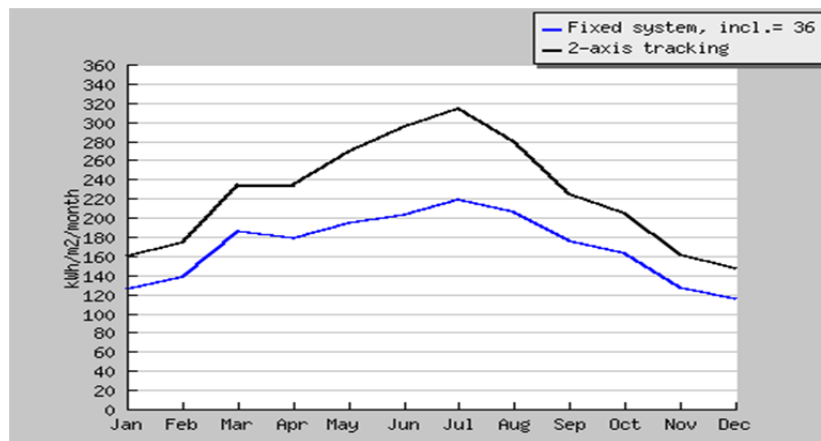

Figure 28. Fixed system vs. 2-axis Sun tracking system - PVGIS-CMSAF

### C. Charge controller: Regulator / MPPT:

**Regulator** – It is an electrical component that controls the flow of DC from the PV panels to the battery to prevent overcharging or over-discharging. As a result, a regulator is a life optimizer for the batteries. They tend to have input voltages of 12 or 24 V, which limits their use with certain types of panels. <sup>[26]</sup>

**MPPT (Maximum Power Point Tracking)** – are an evolution from traditional charge controllers. These power converters analyse the energy flow of the photovoltaic panels and

compare it with their internal algorithm to make the best use available. They enable the use of panels usually employed in grid connecting installations without problems, and they can even reach an input voltage of 150 Vcc. <sup>[26]</sup>

#### D. Batteries

A battery or a battery cell is a device that converts chemical energy into electric energy by moving electrons from a negative pole to a positive pole through a medium environment named electrolyte. It can be exploited for one cycle named dischargeable battery or for more named rechargeable battery by changing the poles. Batteries come in high diversity in electric power, sizes, number of cycles, dischargeable rate and purposes. The most common batteries used in PV installations are:

Name of the Battery	Performance – Lifetime				Specifications
Monobloc Battery	400 cycles to 75% of discharge				Recommended for vacation houses, caravans or ships as a result of low maintenance making it an economical battery.
GEL and AGM monobloc batteries <sup>[27]</sup>	Average Temp.	AGM 'Deep Cycle'	Gel 'Deep Cycle'	Gel 'Long Life'	Low self-discharge (keep full charged for up to 6 months with no important charge losses). Free gas emission during operation makes it optimal for solar installation, caravans and ships.
		Years			
	20°C	7-10	12	20	
	30°C	4	6	10	
	40°C	2	6	5	
Semi-stationary monobloc batteries <sup>[28]</sup>	Flat plate : 50-1000 cycles within 15-18 years at 80% discharge				Tubular batteries have the highest efficiency with low electrolyte pollution.
	Tube plate : 1100 – 1800 cycles in 20 years at 80% discharge				
CPZS	1500 cycles at 80% of discharge				Optimized for intensive use within a high rate of discharge Commercialized in 2V cells.
OPZS	1500 cycles at 80% of discharge				With the option to see the electrolyte level and with low-maintenance, OPZS batteries are commonly used in PV installations.

Table 4. Batteries commonly used for PV installations

#### E. PV inverters and Variable frequency driver

Inverters have the ability to transform direct current (DC) into alternating current (AC). The process transforms the electricity stored in batteries or generated by PV panels (12V, 24V or 48V) into electricity required for appliances or the grid (voltage and frequency). Depending on the needs, an installation can use different types of inverters:

Grid-tie inverters (GTI)	<ul style="list-style-type: none"> <li>to inject power in the grid, a GTI must have the same phase and the same voltage.</li> <li>the highest efficiency recorded for GTI goes up to 94-96%.</li> </ul>						
Stand-alone inverter (Figure 29)	<ul style="list-style-type: none"> <li>frequently used for off-grid power systems .</li> <li>drains the power from the batteries and convert it to required characteristic of energy for the appliances.</li> <li>their efficiency depends on the type of the wave emitted:</li> </ul>						
	<table border="1"> <tr> <td>Square wave inverter</td> <td> <ul style="list-style-type: none"> <li>low price;</li> <li>noise made by harmonic interferences;</li> <li>recommended for small appliances.</li> </ul> </td> </tr> <tr> <td>Modified sine wave inverter</td> <td> <ul style="list-style-type: none"> <li>best quality-price;</li> <li>the waves are similar to the sine waves;</li> <li>recommended for variable frequencies</li> </ul> </td> </tr> <tr> <td>Pure sine wave inverters</td> <td> <ul style="list-style-type: none"> <li>the most efficient</li> <li>high cost in account of high technology required.</li> <li>generates pure sine waves.</li> </ul> </td> </tr> </table>	Square wave inverter	<ul style="list-style-type: none"> <li>low price;</li> <li>noise made by harmonic interferences;</li> <li>recommended for small appliances.</li> </ul>	Modified sine wave inverter	<ul style="list-style-type: none"> <li>best quality-price;</li> <li>the waves are similar to the sine waves;</li> <li>recommended for variable frequencies</li> </ul>	Pure sine wave inverters	<ul style="list-style-type: none"> <li>the most efficient</li> <li>high cost in account of high technology required.</li> <li>generates pure sine waves.</li> </ul>
	Square wave inverter	<ul style="list-style-type: none"> <li>low price;</li> <li>noise made by harmonic interferences;</li> <li>recommended for small appliances.</li> </ul>					
Modified sine wave inverter	<ul style="list-style-type: none"> <li>best quality-price;</li> <li>the waves are similar to the sine waves;</li> <li>recommended for variable frequencies</li> </ul>						
Pure sine wave inverters	<ul style="list-style-type: none"> <li>the most efficient</li> <li>high cost in account of high technology required.</li> <li>generates pure sine waves.</li> </ul>						

Table 5. Inverters

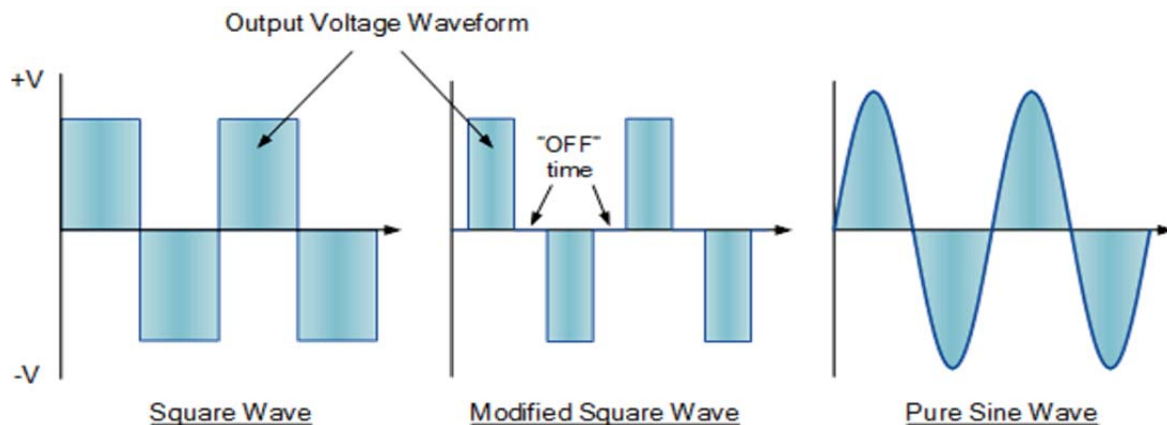

Figure 29. Stand alone inverter waves<sup>[29]</sup>

The variable frequency driver (VFD) or adjustable speed driver (ASD) has the ability to transform DC into AC through 6 isolated gate bipolar transistors (IGBT) that control the voltage and the frequency.

#### F. AC loads

AC loads represent the last link from the electric chain, shortly, the consumer of electricity. There are different for each chain, depending on the purpose of it. In Figure 18 a wide range loads are presented.

#### G. Other aspects

- Cell temperatures.

By warming the temperature of PV-cells, the semiconductor material is losing its properties to become a conductor. Depending on the technology and the material a PV module loses an average of 4% for every 10°C.

- Losses made by wires

Wiring losses are due to their resistance to electrons movement named as “Joule Effect” ( $P = R \times I^2$ ). DC losses may be as high as 1.5 % and AC losses can reach 3 %. [19]

Per total, by combining the elements we can find the following type of systems:

a) PV + VFD + Pump ± Tank → Consumption (Con.);	b) PV + Regulator/ MPPT + Batteries + Inverter + Pump ± Tank → Consumption (Con.)
<ul style="list-style-type: none"> <li>▪ better control on the system: On/OFF</li> <li>▪ multiple speed giving accuracy of flow and pressure;</li> <li>▪ most frequently used for irrigation because of good grades for quality-price;</li> <li>▪ recommended to be used with the tank;</li> <li>▪ costs are compensated in time;</li> <li>▪ difficult to use in changeable weather condition.</li> </ul>	<ul style="list-style-type: none"> <li>▪ the system can be used to provide energy for a variety of energy consumers;</li> <li>▪ can be used in places with changeable weather;</li> <li>▪ higher cost supplied by the extra equipment;</li> <li>▪ costs are compensated in time.</li> </ul>
<p>* Efficiency of the PV system can be increased by using sun tracking system</p>	

Table 6. Differences between systems

### 1.6. Design systems to be compared

For making the complete comparison of the systems, it is necessary to know initially, the equipment used for the installations. Both assemblies are designed to produce energy for the same load. Furthermore, the PV array will contain the same type of PV modules for making a fair comparison. The selection of the equipment is based on the cost-effective rate as well as the competence of devices in favour of high yield.

The final power consumer is a submersible water pump made from stainless steel produced by HN Bombas S.L. The pump model that coincides with the needs is GJ012-25 (Figure 30). In Figure 30 it is shown that at 130m depth, the pump provides 260 l/min. To do so, the three phase engine of the pump requires 11kW of energy.

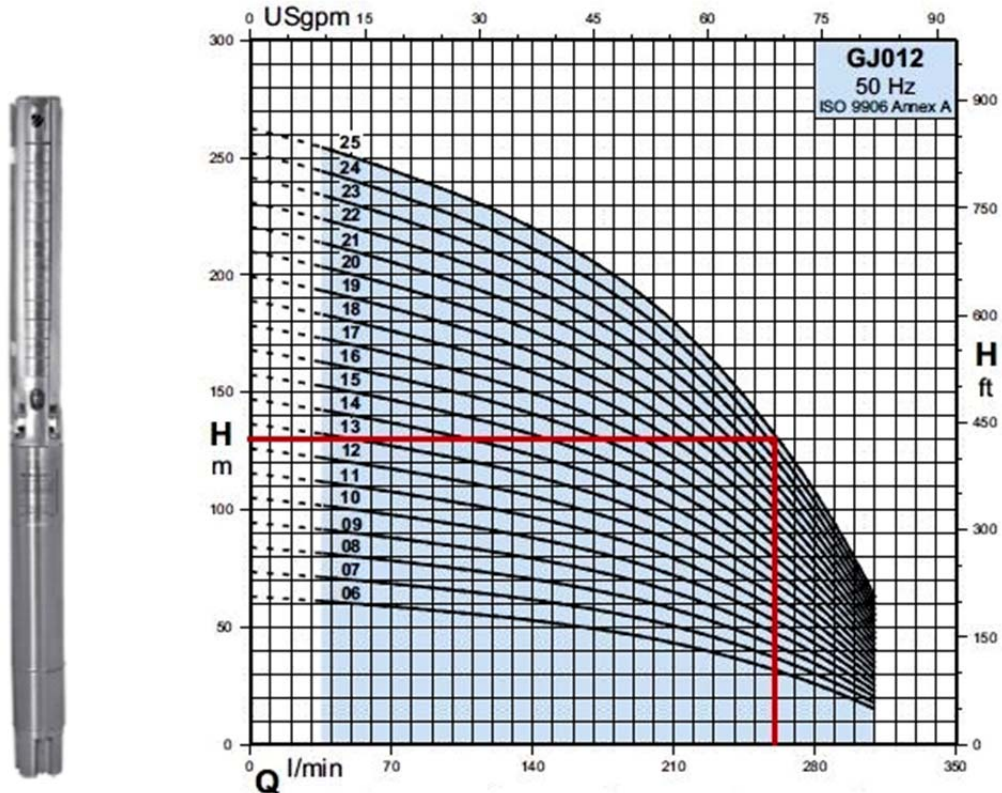

Figure 30. GJ012-25 Pump and flow graphic<sup>[30]</sup>

The energy required to feed the pump will be produced by PV modules AS-6P-310 (Figure 31) manufactured by Amerisolar Co. with a performance of 310 W per module at 17.01 % efficiency of conversion. The company assures a linear power warranty of 91.2 % of the nominal power after 12 years and furthermore 80.6 % of the nominal power after 30 years. This specification can encourage the payback while keeping high performance. The module is made from 72 polycrystalline cells (156x156 mm) distributed 6 x 12. Moreover, the frame of the module is design to support up to 5400 Pa.<sup>[31]</sup>

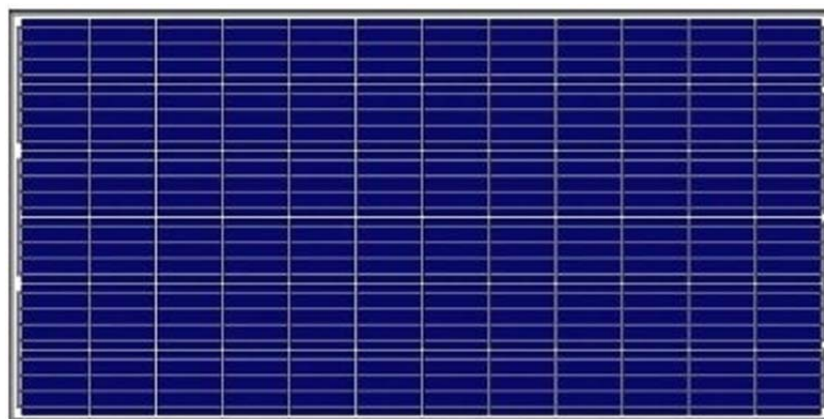

Figure 31. PV module AS-6p-310<sup>[31]</sup>

To make the PV array, the modules will be placed on a structure provided by Turbo Energy Private Limited company that produces a variety of structures at different angles. Because the location of the project is in an agricultural area, the structure has to assure enough height to the modules for a good ventilation and also stability.

To complete the circuit and to connect the PV Array with the pump, it is designed to use one of the 2 ways described in the previous subchapters. As mentioned, the variable frequency driver (VFD) replaced by regulator/ MPPT, batteries and inverter. Each system has different influence over the system with different assets.

The VFD equipment (Figure 32) is selected to be in line with the pump demands as well as with the power of the PV array. As a consequence, the Iksut Solar 425 manufactured by Baico S.L. is preferred because it is able to transform the DC into AC at 11 kW. In addition, it is specially designed to drive a submersible pump for different activities, including irrigation. The body is light (8.5 kg) made from aluminium that helps the two fans from inside to cool down the mechanism.<sup>[32]</sup>



Figure 32. VFD Iksut Solar<sup>[32]</sup>

Even of presenting a lot of advantages including the replacement of Regulator/MPPT, batteries and inverter, the installations that include VFD cannot store the energy for being used in further time.

The regulator and the MPPT are used for the same purpose but there are some differences given by the efficiency of the system and the cost.

Regulator	MPPT
Harvesting the voltage from the PV panels while charging the batteries or giving energy to the inverter	Harvesting the voltage from the PV panels while charging the batteries or giving energy to the inverter
More like a connector between PV panels and the batteries or inverter.	Extracting the full potential from the PV panels in any conditions
Recommended for smaller installation	Works at high efficiency while used at bigger installations
Lower price	Higher price

Table 7. Regulator and MPPT

For the installation is designed to use a MPPT manufactured by Schneider Electric, a German company specialized in electric management that provides different types of electric equipment all around the world. To have a better link between the equipment, the inverter will be provided by the same company giving the opportunity to see the dates on the display for a better control.

The XW MPPT 80 600 model fits with the needs of the installation via its output up to 600 V in DC (operating range 195 – 550 V), load current of 80 A, maximum power at 4800 W

(45 °C) at an efficiency of 96 % nominal power for 48 V battery bank. Moreover, the load controller has incorporated protection for ground faults plus three selectable stages of algorithm for charging conferring manual control in order to maximize the performance according to the needs. The technology installed, Shade Tolerant Fast Sweep™ MPPT, cause better harvesting under partial shadow conditions.<sup>[33]</sup> The purpose of MPPT is to maximize the accumulation of energy and to offer a long life for the battery bank.

To store the energy, the system uses the batteries fabricated by Tab+ Batteries (Figure 33). The reason for using OPzS batteries include: low life discharge, high capacity, low maintenance (water level easy to be checked) and ergonomic. The manufacturer provides a wide range of batteries that provide from 60 Ah up to 2675 Ah in different conditions, recommended to supply energy for self or back up installations.<sup>[34]</sup>



Figure 33. Tab+ Battery - OPzS series<sup>[34]</sup>

The transfer from DC to AC is made by the Schneider inverter, Conext XW+ 5548 NA. This inverter has the ability to work on single phase as well as on three phases from 7 kW to 102 kW in temperatures that can reach 70 °C. The system is able to prioritize solar energy use, peak shaving, load shifting and assists generators with heavy duty loads.<sup>[35]</sup> In addition, the inverter is easy to install being mounted on the wall, share the same display with the MPPT making monitoring easier.

For back-up generator, the installation will use the existing generator shown in Figure 16. Although, to power the pump GJ012-25, it is required 25 % of the capacity of the generator resulting in pointless fuel burn and pollution. Another option could be the purchase of a smaller generator. An example of smaller generator is the one manufactured by Genesal Energy S.L., a company specialized in generators that can be used in different environments and purposes (Gas Generator, Diesel Generator, Hybrid Generators, Marine Generator, Light Tower, Generators for special power). Considering the needs of the system, the generator able to be used is XS Power Gen22KC with sound isolation (Figure 34) that covers the power needs.<sup>[36]</sup>



Figure 34. Genesal Generator XS Power Gen22KC <sup>[36]</sup>

### 1.7. Design of the PV array

Analysing the previews subchapter we can determin the type of structure needed to support the PV modules. The structures have to support 21 kW PV modules representing 68 modules separated in 17 modules/ set or 16 kW PV modules via 52 modules separated in 13 modules/ row. Each system will use the dimension of the module provided in Table 8 (1956x992x50 mm) and will contain 2 series per string (Figure 35).

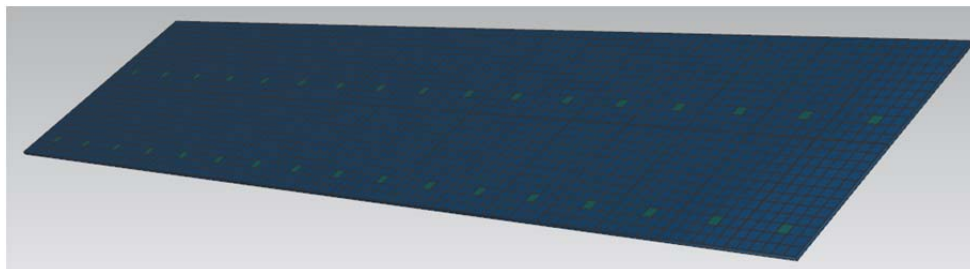

Figure 35. 2 series/ row – 21kW PV installation

The next requirement is to find the separation distance between the rows in order to have a minimum of 4 hours of sun over the PV panels in the shortest day of the year, 21 December (international regulation). For this it is required to know the length of the modules per set. The modules are placed on the structure at 20 mm to each other leading the calculation to the following:

$$2 \text{ (modules)} \times 1956 + 20 = 3932 \text{ mm } (\approx 4 \text{ m}) \quad \text{Eq. (5)}$$

Considering the proper angle to be  $\beta = 20^\circ$  and the length of the set 4m, we can substitute the values shown in the Figures 36 to find the height.



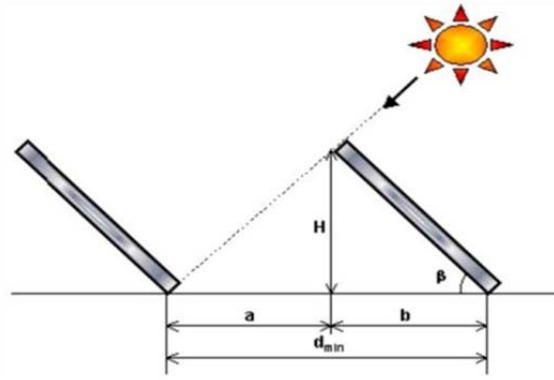

Figure 36. Separation distance<sup>[20]</sup>

$$H = \sin \beta \times \text{length} = \sin 20^\circ \times 4\text{m} = 0.342 \times 4 = 1.368 \text{ m} \quad \text{Eq. (6)}^{[20]}$$

$$b = \cos \beta \times \text{length} = \cos 20^\circ \times 4\text{m} = 0.939 \times 4 = 3.756 \text{ m} \quad \text{Eq. (7)}^{[20]}$$

$$a = \frac{H}{\text{tg}(61^\circ - \text{place latitude})} = \frac{1.368}{\text{tg}(61^\circ - 39.9^\circ)} = \frac{1.368}{\text{tg} 21.1^\circ} = 4.786 \text{ m} \quad \text{Eq. (8)}^{[20]}$$

$$d_{\min} = a + b = 4.786 + 3.756 = 8.542 \text{ m} \quad \text{Eq. (9)}^{[20]}$$

As a result, a minimum distance of 8.542 m can assure 4 hours of sun for both installations. In Table 8 the type of structure used is presented in order to make the PV array like in Figure 37.

Manufacturer	Turbo Energy	
Type	Aluminium structure bend at 20°	
Number of modules	4	2
For 21 kW system	8	1
For 16 kW system	6	1

Table 8. Type of structure



Figure 37. Model of PV array<sup>[37]</sup>

### 1.8. The impact of the project on rural development

As specified above, PV energy presents lots of benefits in rural areas. From economic growth due to low energy price, business stimulation, new job opportunities, low migration rate to big cities to energy sustainability. Depending on the amplitude of the PV installation, these factors can be in different proportion.

Another factor that influences the impact is the purpose of the installation. RE systems can be used for social reasons ordered by the government as well as for private contractors. Therefore, the size of the system can differ in many ways (Table 9).

Type of contractor	Government - society	Private
Dimension	Larger	Smaller
Energy demands	Higher	Lower
Complexity	Higher	Simpler
Cost	High – easier to sustain	High – harder to sustain
Other	Because the installation is for society, more persons have benefits from this	The contractor is the main beneficiary of the installation. Depending on the contractor needs, the private installation can increase in dimension, power and complexity.

Table 9. Difference between the contractors

It must be taken into account that both types are located in rural environments and the most important is to fit in the landscape as well as to preserve the environment while they assure the energy needs.

Over the years, interests in PV energy have grown. In particular in agriculture, all over the Earth there are different types of systems that provide irrigation water in different conditions from different sources. The most common type for isolated areas is the PV installation that uses the VDF in the circuit because of the following reasons:

- Less equipment in the circuit result in lower initial cost as well as easier maintenance;
- Irrigation is mostly required in sunny days when the Sun provides enough energy for the system. In cloudy or rainy days, even if the system does not have enough power for the pump, the irrigation may not be required;
- The VDF can start running the pump at lower frequency in exchange of lower flow. For this situation it is recommended to use a reservoir.

In another train of thoughts, to design a PV installation includes analysis, assembly and maintenance. These steps involve all kinds of resources: human resources (engineers, constructors, etc.), natural resources, financial resources, energy and time. Each resource is

involved in different proportion contributing but also polluting as such. The following subchapters mean to highlight these implications.

### 1.8.1. Environmental impact

Environment impact of the project involves the natural resources used to provide all the conditions to make a project to be realized as well as its strains and emissions in nature. It implies:

- a) Space, landscape and soil manipulation;
- b) Energy exploitation;
- c) Air pollution and green house emission;
- d) Water demand and pollution;
- e) Noise and visual impact;
- f) Waste production and management.

- a) Space, landscape and soil manipulation.

Considering that the project is placed in an agricultural area of 75.660 m<sup>2</sup> located on the hills of Jerica, the facility is designed to not affect the stability of the soil and to use a minimum surface needed that provides the required energy. The soil suffers minimum changes when constructing. Furthermore, the top height of the PV being 2 m, the influence over birdlife is minim due to integration into the landscape.

Soil resources used in all the process are meant to be used in manufacturing the equipment (PV modules, structure, electric components, wires, etc.) as well as to build the structure and not the least, collateral resources used by the people involved in the project. Maintenance of the batteries can produce acid spill leading to small contamination of the area. In consequence, the installation is designed to reduce the entire pollution risks.

- b) Energy exploitation.

Energy exploitation refers to all the resources used to provide electrical and potential energy needed for all the steps of the project, from first steps when designing the project (power for computers), from the time of building the installation (gas for generators and for machines/cars – movement). After building it, all the energy requirements are provided by the installation.

- c) Air pollution and green house emission.

The PV installation does not produce pollution during energy production. The only pollution is made indirectly by the process of manufacturing the PV modules and the building process. However, some pollution is made when the generator is powered. All the stages make a carbon footprint on the environment.

Thus the system is designed to use the generator just in special cases such as maintenance on the PV array or cloudy days. By comparing the dates provided by Weather National Agency of Spain (Table 2) and the maintenance requirements of the equipment, the generator has an

average of 5 days of running per month. Although, depending on the dryness of the soil and the rainy days during each month of the year, the owner has the final decision over the hours of irrigation.

To see the differences between the actual installation, PV system with actual generator, PV system with substitute generator and the grid, it is necessary to taken into account the following data:

- Generator operate in average 1074 hour a year with a consumption of 8.59 l/h;
- Equivalent kgCO<sub>2</sub> emission per one litre of diesel fuel: 2.79 kg<sup>[38]</sup>;
- Grid electrification emission factor: 0.372 kgCO<sub>2</sub>/kWh<sup>[39]</sup>;
- For PV system:
  - 175 hours of operating generator;
  - Energy requirement for all year: 11770 kWh;
  - Actual generator consumption (less than 50 of capacity): 5.73 l/h;
  - Substitute generator consumption (approx. 75% of capacity): 4 l/h;

Source of power	Actual system	PV with actual Generator	PV with substitute Generator	Grid
kgCO <sub>2</sub> per year	25739.59	2797.67	1953	4378.44

Table 10. Equivalent kgCO<sub>2</sub> per energy source

d) Water demand and pollution.

Special for PV installation water is needed for construction mixing it with cement to fix the structure in to the soil. Also, water is used to clean the PV array. Water used for cleaning is provided by the irrigation system itself.

Pollution of the water can be made by pesticides used for agriculture purposes.

e) Noise and visual impact.

Noise pollution has low levels because the installation does not include moving parts. Still, some noise is provided by the generator in the moments of running. For this reason, the generator has a soundproof design to minimize noise.

The visual impact of the installation is minimal being a small installation with a maximum height of 2 m making it unnoticeable.

f) Waste production and management.

In first instance, the PV installation does not produce waste due to the operation system. The wastes produced around the installation are due to initial installation work of the structure, PV modules, equipment and wires and due to the end of life cycle assessment (LCA). For this case, the EU has mentioned in 2012 in Waste Electrical and Electronic Equipment Directive (WEEE) the recycling policy. Applying the regulation of WEEE, the PV installation it is designed to recycle the components by sending it to a collection centre located at 80 km away from the installation point, in Castellón de la Plana. Furthermore, the waste will be sorted depending on material: semiconductors, glass, ferrous and non-ferrous and so on.<sup>[41]</sup>

During LCA of PV modules (20 – 30 years), the batteries are recycled 2-3 times due to their life assessment (around 10 years) in special condition because of the electrolyte toxicity.

Moreover, the company designed a plan in which the wastes from technological process are used to extract oil and essence. The leftover may be sold to a biomass company for woodchips, pellets, sawdust, etc.

### **1.8.2. Social and rural impact**

The purpose of modern technology is to improve the life of the habitants but in a rural environment the social impact of the installation has a big influence for the people. To clarify, the social impacts are as following:

- a) Energy security;
- b) Economic development;
- c) Climate impact.

#### **a) Energy security**

The most important advantage of having an off-grid system involves the economic aspects of it. Many companies give a warranty of at least 15-20 years of operating system without any changes if the operational and maintenance (O&M) requirements are respected.

Energy price from the grid during the years get affected by inflation resulting to higher cost by time. Therefore, the price of the energy produced by PV installation can be considered to be constant and by comparing the prices, the PV installation pays back the investment.

#### **b) Economic development**

Energy price affects the price of the products in many companies leading to competitive deficiency and difficulty in management. Energy security can contribute to adjust the prices and creating competitiveness. Moreover, it can be used in marketing as it gives extra value and distinguish through competition. Giving the purpose of the land, the company helps to supply more food for people from rural and urban areas. In actual situation, the PV installation gives the opportunity to diminish the cost and to increase productivity creating a good opportunity to increase the income and develop the company. The owner is planning to extend the product range by harvesting rosemary in the coming months. More people can be hired in order to take advantage of the new conditions.

In an indirect way, the process to develop and sustain the PV installation involves specialists in different domains such as: engineers, electricians, constructors but also unqualified workers. Besides, it can be used as an example in school projects, making the new generations to be more interested in this field due to the futuristic design and the worldwide information in renewable energy. Furthermore, during the expositions, speeches and local meetings, the benefits of RE can be shared. In addition, by multiplying the PV installation in the area, the young people can be motivated to study RE.

c) Climate impact mitigation

The data in Table 10 shows the different quantity of equivalent CO<sub>2</sub> released into the local atmosphere in one year. From that we can determine the total of tCO<sub>2</sub> released in 20 years as shown in Figure 38 and Table 11.

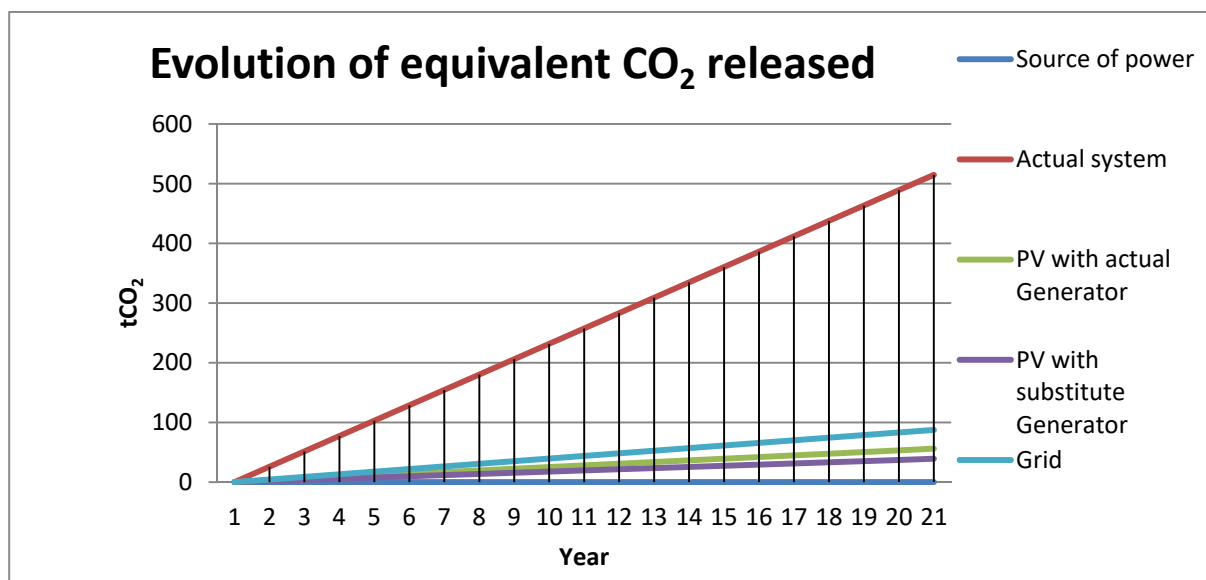

Figure 38. Evolution of equivalent CO<sub>2</sub> released in 20 years

Source of power \ Year	Actual system	PV with actual generator	PV with substitute generator	Grid
1	25,740	2,798	1,953	4,378
2	51,479	5,595	3,906	8,757
3	77,219	8,393	5,859	13,135
4	102,958	11,191	7,812	17,514
5	128,698	13,988	9,765	21,892
6	154,438	16,786	11,718	26,271
7	180,177	19,584	13,671	30,649
8	205,917	22,381	15,624	35,028
9	231,656	25,179	17,577	39,406
10	257,396	27,977	19,530	43,784
11	283,135	30,774	21,483	48,163
12	308,875	33,572	23,436	52,541
13	334,615	36,370	25,389	56,920
14	360,354	39,167	27,342	61,298
15	386,094	41,965	29,295	65,677
16	411,833	44,763	31,248	70,055
17	437,573	47,560	33,201	74,433

18	463,313	50,358	35,154	78,812
19	489,052	53,156	37,107	83,190
20	514,792	55,953	39,060	87,569

Table 11. Equivalent tCO<sub>2</sub> in 20 years

This analysis reveals the climate benefits of changing the actual system. Each situation presents a high reduction of greenhouse emissions:

- PV with actual generator: 89.13 %;
- PV with substitute generator: 92.41 %.

## 1.9. Conclusions

Given the purpose of the project, the final installation was chosen from four possible installations, based on many factors showed in every chapter. Starting from the first chapter, we can see the technical differences of the installations with advantages and disadvantages that fit for our case. These differences are highlighted in the second chapter for a better analysis, resulting in the plans presented in chapter 4. Starting from the technical data, an economic analysis was made in chapter 3 in order to see the costs and the payback time of the installations.

Therefore, the most convenient installation is the photovoltaic installation of 21 kW power that uses variable frequency driver to power the water pump. As a backup system a Genesal generator is recommended to be used.

The decision was made given the following main reasons:

- irrigation is not a priority during cloudy and rainy days;
- it is easy to maintain the system;
- low initial investment & low O&M cost;
- pollution is at the minimum. When the generator is not used, the installation will not emit any greenhouse emission;
- the owner saves a big amount of money that can be reinvested or used in different activities for the local environment.

The installation gives more benefits over the year for the local area:

- promoter of RE in rural area;
- it can stimulate people to use RE;
- it is a good example for others how to benefits from RE.

Based on the analyses and the estimations, the owner of the land has improved his management plan. As a result, he has decided to extend the product range of the company and to get involved in more activities in relation to rural development due to the social impact of the company.

## 1.10. References

Web references:

- [1] Shubhangi Khapre (2016.03.08). Maharashtra budget 2016-17: Deadline for irrigation projects likely. URL:<http://indianexpress.com/article/cities/mumbai/maharashtra-budget-2016-17-deadline-for-irrigation-projects-likely/>
- [2] Groundwater Engineering Limited (2014.03.03). Introduction to solar water pumping. URL:<https://www.groundwatereng.com/blog/2014/03/introduction-to-solar-water-pumping>
- [3] IRENA (2016). Renewable Energy and Jobs, Annual Review 2016. URL:[http://seforall.org/sites/default/files/IRENA\\_RE\\_Jobs\\_Annual\\_Review\\_2016.pdf](http://seforall.org/sites/default/files/IRENA_RE_Jobs_Annual_Review_2016.pdf)
- [4] Directive 2009/28/EC of the European Parliament and of the Council of 23 April 2009. URL:<http://eur-lex.europa.eu/legal-content/EN/ALL/?uri=celex%3A32009L0028>
- [5] REN21 (2016). RENEWABLES GLOBAL STATUS REPORT 2015. URL:[http://www.ren21.net/wpcontent/uploads/2015/07/REN12GSR2015\\_Onlinebook\\_low1.pdf](http://www.ren21.net/wpcontent/uploads/2015/07/REN12GSR2015_Onlinebook_low1.pdf)
- [6] Eurostat (2013 February). Rural development statistics by urban-rural typology. URL:[http://ec.europa.eu/eurostat/statistics-explained/index.php/Rural\\_development\\_statistics\\_by\\_urban-rural\\_typology](http://ec.europa.eu/eurostat/statistics-explained/index.php/Rural_development_statistics_by_urban-rural_typology) )
- [7] URL:[http://www.geohive.com/earth/pop\\_urban.aspx](http://www.geohive.com/earth/pop_urban.aspx)
- [9] Wikipedia (2017.03.28). Jérica. URL:<https://en.wikipedia.org/wiki/J%C3%A9rica>
- [10] Google Maps. URL:<https://www.google.ro/maps/place/J%C3%A9rica,+12450,+Castell%C3%B3n,+Spain/@39.8565044,0.7929493,10.08z/data=!4m5!3m4!1s0xd607dfdd52a96ed:0x402af6ed72240f0!8m2!3d39.8873558!4d-0.5730713>
- [11] Photovoltaic geographical information system (PVGIS). URL:<http://re.jrc.ec.europa.eu/pvgis/apps4/MRcalc.php>
- [12] Photovoltaic geographical information system (PVGIS). URL:<http://re.jrc.ec.europa.eu/pvgis/apps4/DRcalc.php>
- [13] Spain's National Meteorological Agency. URL:<http://www.aemet.es/en/serviciosclimaticos/datosclimatologicos/valoresclimatologicos?l=8500A&k=val>
- [14] Wikipedia (2017.03.28). Jérica. URL: <https://en.wikipedia.org/wiki/J%C3%A9rica#Economy>
- [18] LEONICS CO. Stand-alone Solar Power System. URL:[http://www.leonics.com/system/solar\\_photovoltaic/stand\\_alone\\_solar\\_power\\_system/stand\\_alone\\_solar\\_power\\_system\\_en.php](http://www.leonics.com/system/solar_photovoltaic/stand_alone_solar_power_system/stand_alone_solar_power_system_en.php)
- [20] Wikipedia (2017). Sunlight. URL:<https://en.wikipedia.org/wiki/Sunlight>
- [21] URL:<http://www.biofuturo.net/>



- [23] URL:<http://lifefreeenergy.com/w/what-is-photovoltaic-panels.html>
- [24] URL:<http://delmonsolar.com/Products.php>
- [25] GPIIISolar. Solar Tracking. URL:[http://www.gpiisolar.com/solar\\_tracking/tracking\\_system](http://www.gpiisolar.com/solar_tracking/tracking_system)
- [27] Victron Energy. Gel and AGM Batteries. URL:<https://www.victronenergy.com/upload/documents/Datasheet-GEL-and-AGM-Batteries-EN.pdf>
- [28] SBS LLC. Comparison Between Flat and Tubular Positive Plates. URL:[http://www.sbsbattery.com/PDFs/SBS\\_WP\\_101\\_BattComp-WithRefs.pdf](http://www.sbsbattery.com/PDFs/SBS_WP_101_BattComp-WithRefs.pdf)
- [29] Alternative Energy Tutorials. Solar Power Inverter. URL:<http://www.alternative-energy-tutorials.com/solar-power/solar-power-inverter.html>
- [33] Schneider Electric (2013.01.16). XW MPPT 80 600 (Annex 6). URL:<http://www.schneider-electric.com/press/es/es/schneider-electric-presenta-su-nuevo-controlador-de-carga-xw-mppt-80-600/?isDisplayed=1&lastUpdate=01/21/2013>
- [34] Tab + Batteries. URL:[http://www.tab.si/index.php/industrial/display\\_stationary/2](http://www.tab.si/index.php/industrial/display_stationary/2)
- [35] Schneider Electric. Conext XW+ NA (Annex 7). URL:[http://solar.schneider-electric.com/wp-content/uploads/2015/10/Conext-XW-NA-Datasheet\\_ENG.pdf](http://solar.schneider-electric.com/wp-content/uploads/2015/10/Conext-XW-NA-Datasheet_ENG.pdf)
- [37] URL:[http://www.x-elio.com/sites/default/files/styles/structure\\_big/public/hap\\_2p\\_11.jpg?itok=gSEdew\\_e](http://www.x-elio.com/sites/default/files/styles/structure_big/public/hap_2p_11.jpg?itok=gSEdew_e)
- [38] Emission factors in kg CO<sub>2</sub>-equivalent per unit. URL:<https://www.researchgate.net/file/PostFileLoader.html?id=577fbc1996b7e4acc040a883&assetKey=AS%3A381587750440960%401467989017021>

In2Rural Courses:

- [19] Module 2, Chapter 1, Part 1-1
- [26] Module 2 – Chapter 1, part 1-2
- [39] Module 2 – Chapter 4, part 4-3
- [40] Module 2 - Chapter 3, part 3-1
- [41] Module 2 – Chapter 1, part 1-3
- [42] Module 2 - Chapter 2, part 2-1
- [43] Module 2 - Chapter 2, part 2-2

Annexes:

- [15] Heliotec Case study. [Annex 1 - Heliotec Case Study - Bombeo Solar Fotovoltaico](#)



- [16] Carod Generator. [Annex 2 - Generator Carod CTM-6 L](#)
- [30]HN Bombas (2016). [Annex 3 - HN Bombas - GJ012-25](#)
- [31]Amerisolar Co. [Annex 4 - Amerisolar PV Module - AS-6P-310](#)
- [32] Baico. [Annex 5 - Baico VFD - ISKUT Solar 425](#)
- [36] Genesal Electric. [Annex 8 - Generator Genesal Energy XS POWER GEN22KC](#)

Other sources:

- [17]Helitec. [Irrigation system designed to be changed](#)
- [8] Renewable Energy to Rural Development - Executive Summary Brief for Policy Makers
- [22] Solar Radiation Atlas for Spain based on Surface Irradiance Data from EUMETSAT Climate Monitoring-SAF



**Compilation of case studies of applying renewable energies to local development transnationally implemented**



Co-funded by the  
Erasmus+ Programme  
of the European Union





# Calculations



**Compilation of case studies of applying renewable energies to local development transnationally implemented**



Co-funded by the  
Erasmus+ Programme  
of the European Union



## 2. Calculations and design

The following calculation and design is specific for the location provided (near to Jérica, Castellón, Spain. Coordonate: 39°54' N 00°34' W) within the 3 month of summer: June, July and August. The system has a nominal time of running for 5 hours daily.

The calculations are related to the information provided by the Photovoltaic Geographical Information System (PVGIS) for a photovoltaic installation fixed on a structure inclined at 20° ( Chapter 1.5.A.b).

First of all, the calculation will refer to the system that operates without batteries followed by the calculation for a system that operates with batteries.

### 2.1 Energy demand, system losses and performance rate

The starting point of this project is given by the client. In the interest of raising the productivity of the land for almond, an irrigation system is required. Because the flow of surface water is low, the next option is to submerge a water pump into the ground. The optimal depth for the ordered pump is situated 130 m providing 260 l/min. As the surface area is 75.660 m<sup>2</sup>, we can calculate the flow for an hour per m<sup>2</sup>.

$$260 \text{ l/min} \times 60 = 15600 \text{ l/h} \quad \text{Eq. (10)}$$

$$75660 \text{ m}^2 / 15600 \text{ l/h} = 4.85 \text{ l/m}^2 \quad \text{Eq. (11)}$$

To determine the consumption of the pump daily, monthly and season, technical data provided by the manufacturer is required. (Table 12)

Table 12. Water pump<sup>[30]</sup>

Manufacturer		HN Bombas	
Model		GJ012-25	
kW	HP	11	15
Voltage		400 V	
Nominal Frequency		50 Hz	
Nominal flow		200 l/min	
Flow range		35 - 31 l/min	
Maximum depth		431 m	
Maxim efficiency		60 %	
Nominal speed		2900 rpm	

Knowing the power of the pump and the average hours of running per month, we can calculate monthly consumption and total consumption per year.

Table 13. Monthly consumption

Month	Mar.	Apr.	May	June	July	Aug.	Sept.	Oct.	Nov.
Hours	3	4	4	5	5	5	4	3	2
Days	31	30	31	30	31	31	30	31	30
Cons. (kW)	1023	1320	1364	1650	1705	1705	1320	1023	660
Total consumption									11770

To design a proper installation, the losses of the system have to be taken into account. In our case, the losses are estimated as in the following:

- Azimuth (horizontal angle) is 0° resulting 0% orientation loss;
- Dirt loss is considered to be 5 %;
- Shadow and cabling loss: 2 % & 4 %;
- VFD / inverter performance: 96 %;
- Regulator/ MPPT performance: 97 %;
- Battery performance: 80 %;
- Cells temperature losses estimated to be 4 % per every 10° C.

These losses are calculated as a performance rate (PR). By using the data provided by PVGIS, PR can be determined as in the next equation:

$$PR = \frac{\text{Production}}{\text{Radiation}} \quad (\text{Eq. 12})$$

Table 14. Performance Rate<sup>[11]</sup>

Month	E <sub>d</sub>	E <sub>m</sub>	H <sub>d</sub>	H <sub>m</sub>	PR <sub>d</sub>	PR <sub>m</sub>
January	2.72	84.2	3.39	105	0.802	0.802
February	3.46	96.8	4.35	122	0.795	0.793
March	4.36	135	5.63	174	0.774	0.776
April	4.51	135	5.95	178	0.758	0.758
May	4.89	152	6.57	204	0.744	0.745
June	5.36	161	7.31	219	0.733	0.735
July	5.43	168	7.5	233	0.724	0.721
August	4.93	153	6.8	211	0.725	0.725
September	4.15	125	5.62	168	0.738	0.744
October	3.58	111	4.74	147	0.755	0.755
November	2.82	84.7	3.6	108	0.783	0.784
December	2.43	75.4	3.04	94.4	0.799	0.799
Annual average	4.06	123	5.38	164	0.755	0.75
Annual total	1480		1960		0.755	

Acronyms:

- E<sub>d</sub> - Average daily electricity production from the given system (kWh)
- E<sub>m</sub> - Average monthly electricity production from the given system (kWh)
- H<sub>d</sub> - Average daily sum of global irradiation per square meter received by the modules of the given system (kWh/m<sup>2</sup>)
- H<sub>m</sub> - Average sum of global irradiation per square meter received by the modules of the given system (kWh/m<sup>2</sup>)

In order to maximise the installation for the summer months, the values that are going to be used are: June – 0.73 (73 %), July – 0.72 (72 %), August – 0.72 (72 %). These values need to be multiplied with the daily Global irradiation (G) in order to determine the power of the PV panels. As a result, the differences can be seen in the following figures:

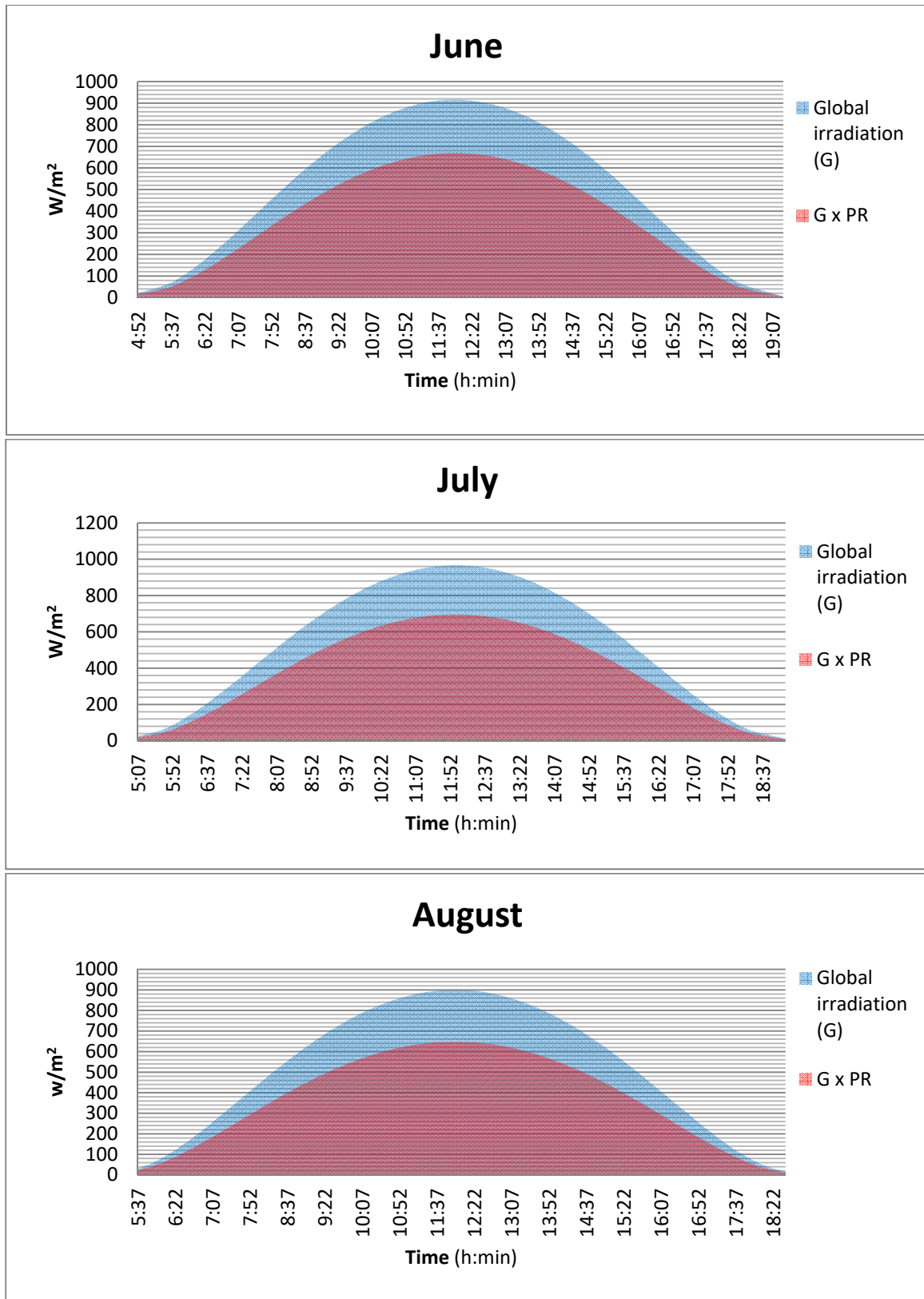

Figure 39. Average daily graphics of Global Irradiation by performance rate per month



Table 15. Values in different time of Global Irradiation<sup>[12]</sup> by performance rate per month

Time	June		July		August	
	Global irradiation (G)	$G \times PR$	Global irradiation (G)	$G \times PR$	Global irradiation (G)	$G \times PR$
5:22	49	35.77	40	28.8	0	0
5:37	68	49.64	56	40.32	32	23.04
6:22	174	127.02	161	115.92	120	86.4
6:37	217	158.41	206	148.32	162	116.64
7:22	357	260.61	355	255.6	306	220.32
7:37	405	295.65	407	293.04	356	256.32
7:52	454	331.42	459	330.48	407	293.04
8:07	501	365.73	511	367.92	457	329.04
8:22	548	400.04	561	403.92	506	364.32
8:37	592	432.16	610	439.2	554	398.88
8:52	635	463.55	657	473.04	600	432
9:07	676	493.48	701	504.72	643	462.96
9:22	714	521.22	743	534.96	684	492.48
9:37	749	546.77	782	563.04	722	519.84
9:52	782	570.86	817	588.24	756	544.32
10:07	811	592.03	850	612	788	567.36
10:22	837	611.01	878	632.16	815	586.8
10:37	859	627.07	903	650.16	839	604.08
10:52	878	640.94	924	665.28	859	618.48
11:07	893	651.89	941	677.52	876	630.72
11:22	905	660.65	953	686.16	888	639.36
11:37	912	665.76	962	692.64	896	645.12
11:52	916	668.68	966	695.52	900	648
12:07	916	668.68	966	695.52	900	648
12:22	912	665.76	962	692.64	896	645.12
12:37	905	660.65	953	686.16	888	639.36
12:52	893	651.89	941	677.52	876	630.72
13:07	878	640.94	924	665.28	859	618.48
13:22	859	627.07	903	650.16	839	604.08
13:37	837	611.01	878	632.16	815	586.8
13:52	811	592.03	850	612	788	567.36
14:07	782	570.86	817	588.24	756	544.32
14:22	749	546.77	782	563.04	722	519.84
14:37	714	521.22	743	534.96	684	492.48
14:52	676	493.48	701	504.72	643	462.96
15:07	635	463.55	657	473.04	600	432
15:22	592	432.16	610	439.2	554	398.88
15:37	548	400.04	561	403.92	506	364.32
16:22	405	295.65	407	293.04	356	256.32
16:37	357	260.61	355	255.6	306	220.32
17:22	217	158.41	206	148.32	162	116.64
17:37	174	127.02	161	115.92	120	86.4
18:22	68	49.64	56	40.32	32	23.04

## 2.2 Installation sizing and selection of the equipment

To determine the size of the installation and the optimal equipment it is needed to establish the running hours in order to harvest the highest quantity of solar energy. For this reason, the installation is programmed to work between 9:22 and 14:22 when there is enough irradiation. As a result, power consumption is divided by irradiation values produced from 9:22 to 9:37 giving the power of PV panels needed (Table 16).

Table 16. Irradiation values in running hours

June			July			August		
Time	G	G × PR	Time	G	G × PR	Time	G	G × PR
9:22	714	521.22	9:22	743	542.39	9:22	684	492.48
9:37	749	546.77	9:37	782	570.86	9:37	722	519.84
9:52	782	570.86	9:52	817	596.41	9:52	756	544.32
10:07	811	592.03	10:07	850	620.5	10:07	788	567.36
10:22	837	611.01	10:22	878	640.94	10:22	815	586.8
10:37	859	627.07	10:37	903	659.19	10:37	839	604.08
10:52	878	640.94	10:52	924	674.52	10:52	859	618.48
11:07	893	651.89	11:07	941	686.93	11:07	876	630.72
11:22	905	660.65	11:22	953	695.69	11:22	888	639.36
11:37	912	665.76	11:37	962	702.26	11:37	896	645.12
11:52	916	668.68	11:52	966	705.18	11:52	900	648
12:07	916	668.68	12:07	966	705.18	12:07	900	648
12:22	912	665.76	12:22	962	702.26	12:22	896	645.12
12:37	905	660.65	12:37	953	695.69	12:37	888	639.36
12:52	893	651.89	12:52	941	686.93	12:52	876	630.72
13:07	878	640.94	13:07	924	674.52	13:07	859	618.48
13:22	859	627.07	13:22	903	659.19	13:22	839	604.08
13:37	837	611.01	13:37	878	640.94	13:37	815	586.8
13:52	811	592.03	13:52	850	620.5	13:52	788	567.36
14:07	782	570.86	14:07	817	596.41	14:07	756	544.32
14:22	749	546.77	14:22	782	570.86	14:22	722	519.84

June:  $11000/546.77 = 20.12 \text{ kW}$  Eq. (13)

July:  $11000/570.86 = 19.27 \text{ kW}$  Eq. (14)

August:  $11000/519.84 = 21.16 \text{ kW}$  Eq. (15)

Since the radiation level for August is lower resulting 21.16 kW, the PV installation power will be designed for 21 kW. For a better perspective, in Figure 39 the amount of consumption related with the power of the PV installation is presented.

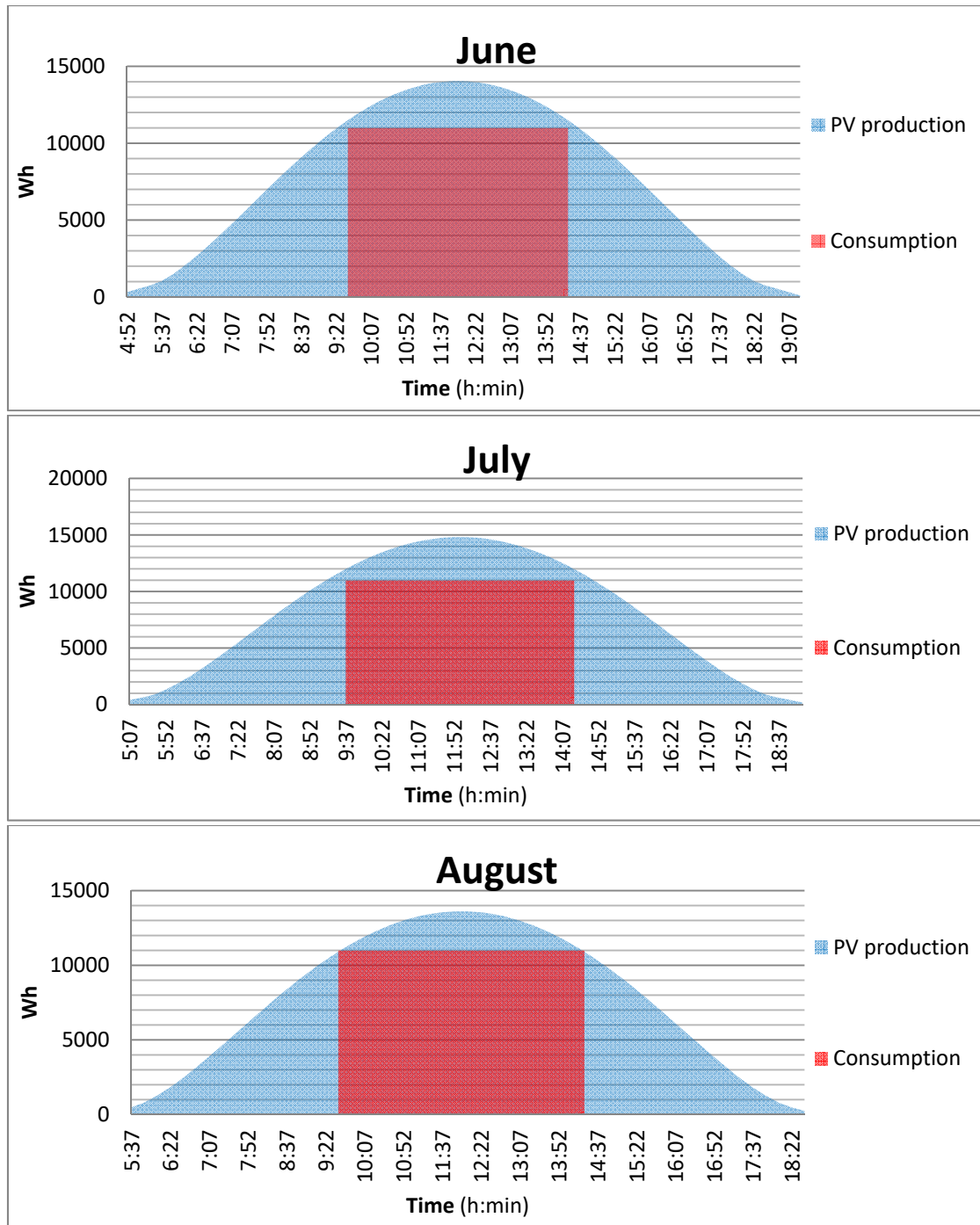

Figure 40. Generated power vs. Consumption

Even though the energy produced by the PV installation can change every day because of the weather, and the deficiency of the generated power can be covered in different ways.

In the first situation, the deficit of the energy can be supplied by reducing the frequency of the installation from 50 Hz to 40 Hz with the VFD, which could lead to extra hours of running during the normal days with the consequence of lower flow of the pump.

Another way to supply the energy needed is by introducing batteries in the system. This gives the possibility to the pump to run in different times of the day as well as having the option to design a PV array for a smaller quantity of energy.

The number of PV modules is determined by dividing the power needed with the nominal power ( $P_{max}$ ) of the chosen model of PV module (Table 17) resulting in equation 16.

Table 17. AS-6P-310, Amerisolar<sup>[31]</sup>

Manufacturer	Amerisolar
Model	AS-6P-310
Nominal Power ( $P_{max}$ )	310 W
Open Circuit Voltage ( $V_{oc}$ )	45.5 V
Short Circuit Current ( $I_{sc}$ )	8.85 A
Voltage at Nominal Power ( $V_{mp}$ )	36.9 V
Current at Nominal Power ( $I_{mp}$ )	8.41 A
Module Efficiency (%)	15.98
Cell Type	Polycrystalline (156x156 mm)
Number of cells	72 (6x12)
Module Dimension	1956x992x50 mm
Weight	27 kg
Front cover	4.0 mm low-iron tempered glass
Frame	Anodized aluminium alloy
Junction box	IP67, 6 diodes
Cables	4 mm <sup>2</sup> , 1000 mm
Connector	MC4 or MC4 compatible

$$21000/310 = 67.7419 \quad \text{Eq. (16)}$$

Because of equation 16, the PV array will contain 68 modules which can ensure a maximum nominal power of 21080 W (21.08 kW).

Furthermore, a VFD is chosen considering the type of the PV module (Table 8) and the characteristics of the water pump (Table 5).

Table 18. ISKUT SOLAR 425<sup>[32]</sup>

Manufacturer	Baico
Model	ISKUT SOLAR 425
$V_{in}$ (VDC)	320 - 850 V
$V_{in P1 nom*}$ (VDC)	> 560V
Max V out (VAC)	3 x 400 V
Max I out (A)	25
Weight	8.5 kg

To produce the Max V out = 3x400 V, the VFD need a Min V in of 565 V. To provide enough voltage for the VFD, the PV modules will be divided into 2 strings with 34 modules (2 rows of 17 modules per string).

$$17 \times 36.9V = 627.3 \text{ V (VDC)} \quad \text{Eq. (17)}$$

As a backup source of energy, the installation has the possibility to connect a generator. This option is available when the energy from the PV is not enough to run the pump (Figure 40).

The connection is made through an automatic switcher that makes the transfer from the PV energy to the generator.

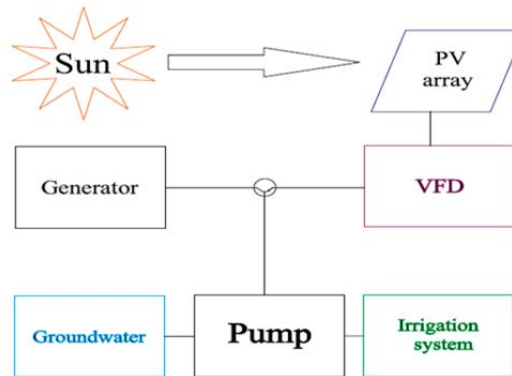

Figure 40 Connection of generator to a PV installation using VFD

For economic reasons, the actual generator will be connected to a PV installation even though it is used at low capacity. Nevertheless, the generator shown in Figure 16 may be substituted by the generator shown in Figure 34. The differences between them are shown in Table 19.

Table 19. CTM-60 L<sup>[16]</sup> vs. XS Power Gen22KC<sup>[36]</sup>

Manufacturer		Carod	Genesal Energy
Model		CTM-60 L	XS POWER GEN22KC
Frequency		50 Hz	50 Hz
Voltage		400 V	230 / 400 V
PRM power kVa/kW		60 / 48	20 / 16
STP power kVA/kW		62.5 / 50	22/17.6
Rated at power factor ( cos $\phi$ )		0.8	0.8
Speed		1500 rpm	1500 rpm
Consumption	100 %	11.46 l/h	5.3 l/h
	75 %	8.59 l/h	4 l/h
	50 %	5.73 l/h	N/A

Another way to distribute the power from the panels to the pump is by using the circuit Regulator/MPPT-Batteries-Inverter. This presents the advantage of a smaller PV array but contains more equipment on the energy distribution.

Using the same condition as in the previous model, regarding environment condition, system losses and PV module, the installation will be decided by comparing the minimum of energy required for normal use without batteries and the cost of the equipment in use of batteries. From these terms, it was chosen to install a PV array of 16.1 kW (52 modules AS-P6-310).

Considering the same average of radiation per month, the difference of the power required will be provided by the batteries. As shown in Figure 41, the batteries will be charged during the day when the consumption of energy is nil.

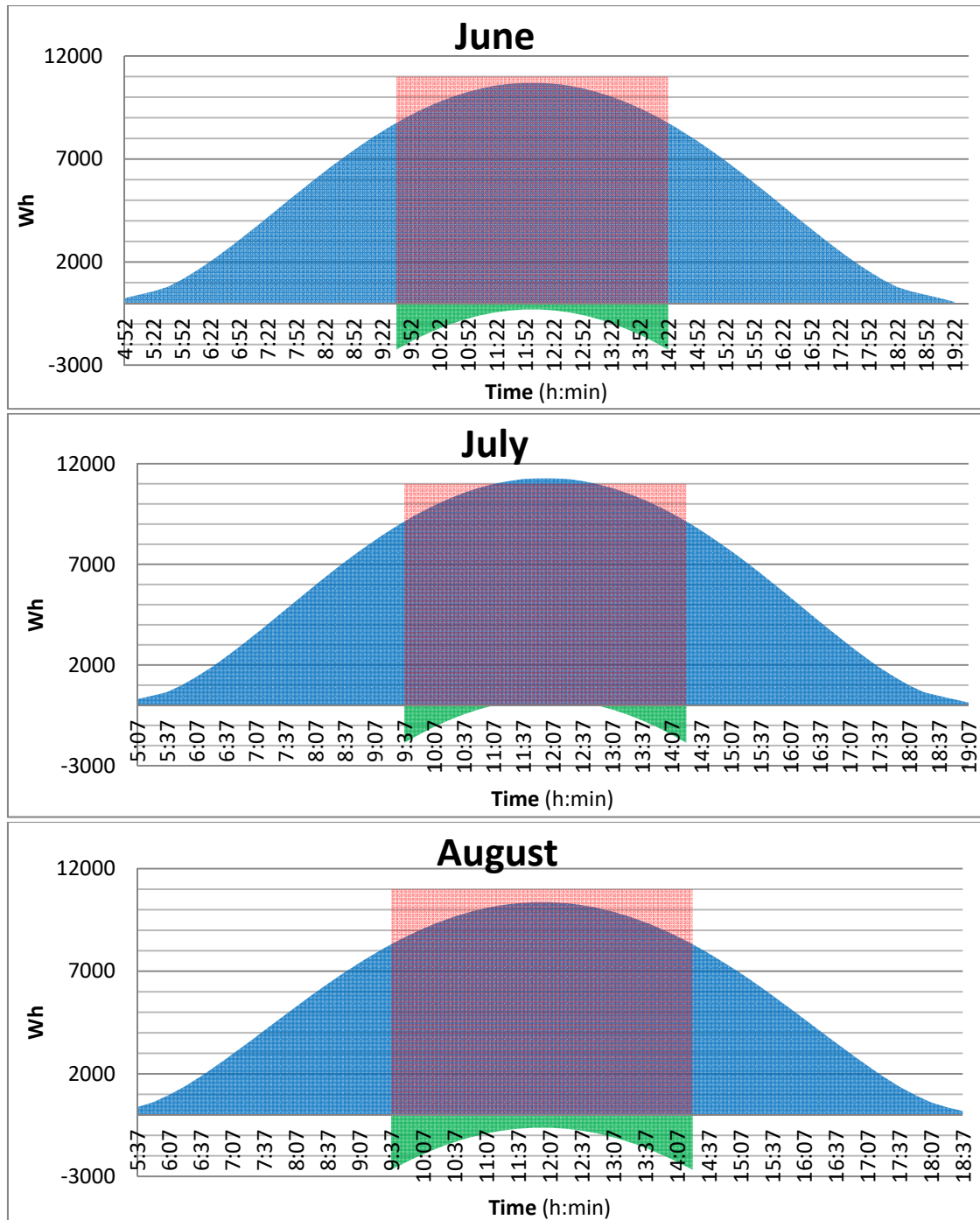

Figure 41. Production, Consumption, Energy from batteries

- Legend:
- blue - PV production (16 kW installation);
  - red - Consumption;
  - purple - Consumption sustained by PV panels;
  - green - Consumption sustained by batteries.

It can be observed that in July the average daily irradiation is enough to make the PV panels generate 11 kW of power during the hours between 11:22 – 12:37.

The modules are designed to be placed in the same position similarly to the previous design, with 26 modules per string. Each string is designed to be connected to a MPPT in order to

collect the energy for the batteries or to give it for use during the consumption time. The MPPT that fits the needs is XW MPPT 80 600 (Table 20).

Table 20. XW MPPT 80 600, Schneider Electric <sup>[33]</sup>

Manufacturer	Schneider Electric
Model	XW MPPT 80 600
Nominal battery voltage	24 and 48 V (Default is 48 V)
PV array operating voltage	195 to 550 V
Max. PV array open circuit range	600 V including temperature correction
Battery voltage operating range	16 to 67 VDC
Array short-circuit current	35A (28 A @STC)
Max. charge current	80 A
Max. and min. wire size in conduit	#6 AWG to #14 AWG (13.5 to 2.5 mm <sup>2</sup> )
Max. output power	2560W (nominal 24 V), 4800W (nominal 48 V)
Max. power conversion efficiency	94% (nominal 24 V), 96% (nominal 48V)

By connecting 13 modules in series, the obtained values are situated in the parameters of the MPPT (Table 20).

$$13 \times 36.9 \text{ V (V}_{mp}) = 479.7 \text{ V} \quad (550 \text{ V}) \quad \text{Eq. (18)}$$

$$13 \times 45.5 \text{ V (V}_{oc}) = 591.5 \text{ V} \quad (600 \text{ V}) \quad \text{Eq. (19)}$$

$$13 \times 310 \text{ W (P}_{max}) = 4030 \text{ W} \quad (4800 \text{ W}) \quad \text{Eq. (20)}$$

Thus, the installation will contain 4 XW MPPT 80 600, one for each 13 modules, connected to the batteries

To find the batteries capacity required for 16kW PV system, first we need to see the uncovered energy needed for consumption (Table 21) and to apply the following formula with the specification that the autonomy of the batteries is chosen for 1 day. The autonomy has been selected to be optimal for the purpose of irrigation.

$$C_{bat} = \frac{1.1 \times E_d \times A}{V_{bat} \times DOD_{max}} \quad \text{Eq. (21)}^{[41]}$$

- $C_{bat}$  – capacity of the battery
- $E_d$  – energy required
- $A$  – autonomy
- $V_{bat}$  – Battery voltage; 48 V
- $DOD_{max}$  – Depth of discharge – 50 %

Table 21. Uncovered energy by the PV panels

Time	Consumption	Production 16 kW	Production 16 kW	Production 16 kW
9:22	11000	8339.52	8678.24	7879.68
9:37	11000	8748.32	9133.76	8317.44
9:52	11000	9133.76	9542.56	8709.12
10:07	11000	9472.48	9928.00	9077.76
10:22	11000	9776.16	10255.04	9388.80
10:37	11000	10033.12	10547.04	9665.28
10:52	11000	10255.04	10792.32	9895.68
11:07	11000	10430.24	10990.88	10091.52
11:22	11000	10570.40	11131.04	10229.76
11:37	11000	10652.16	11236.16	10321.92
11:52	11000	10698.88	11282.88	10368.00
12:07	11000	10698.88	11282.88	10368.00
12:22	11000	10652.16	11236.16	10321.92
12:37	11000	10570.40	11131.04	10229.76
12:52	11000	10430.24	10990.88	10091.52
13:07	11000	10255.04	10792.32	9895.68
13:22	11000	10033.12	10547.04	9665.28
13:37	11000	9776.16	10255.04	9388.80
13:52	11000	9472.48	9928.00	9077.76
14:07	11000	9133.76	9542.56	8709.12
14:22	11000	8748.32	9133.76	8317.44
Energy difference		23119	13943	30990

As a result, the energy required to overlay are the following:

June 23,12 kW  
 July 13,94 kW  
 August 30,99 kW

$$C_{bat} = \frac{1.1 \times E_d \times A}{V_{bat} \times DOD_{max}} = \frac{1.1 \times 30990 \times 1}{48 \times 0.5} = 1420.37 Ah \quad \text{Eq. (22)}$$

Since the minimum capacity of the batteries must have at least 1420.37 Ah, from the diversity of the batteries of Tab+ manufactures, it is designed to use the model 12 OPzS mentioned in Table 22. To reach the 48 V, 24 batteries will be connected in series.

Table 22. 12 OPzS 1500, Tab + <sup>[34]</sup>

Batteries	Characteristics
Manufacturer	Tab+
Model	12 OPzS 1500
Voltage	2 V
Ah C10	1613

The last equipment needed in the system is the inverter. To choose the proper one we have to calculate the minimum power of it. Also it must be taken into account that the pump is with 3 phases, resulting one inverter per each phase.



$$P_{inv} = \frac{P_{cons} \times 1.25}{3} = \frac{11 \text{ kW} \times 1.25}{3} = \frac{13.75}{3} = 4.58 \text{ kW/phase} \quad \text{Eq. (23)}^{[41]}$$

- $P_{inv}$  – power inverter;  
 $P_{cons}$  – consumer power.

In order to improve the performance of the system, the inverter Conext XW+ 5548 NA is chosen from the same manufacturer as the MPPT with the bonus of having the parameters on the same display. Other benefits of the particular inverter includes an automatic switch between the PV array, batteries and the generator (backup system).

Table 23. Conext XW+ 5548 NA, Schneider Electric <sup>[35]</sup>

Manufacturer	Schneider Electric
Model	Conext XW+ 5548 NA
Output power at 25°C	5500 W
Output power at 40°C	4500 W
Output frequency	50 / 60 Hz
Input DC voltage range	42 / 60 V (48 nominal)
Max. input DC current	150 A
Charger Dc output	
Max. output charge current	110 A
Output voltage range	40-64 (nominal 48 V)
Battery bank range	440-10000 Ah

As mentioned earlier, the backup energy source can be represented by the generators specified before. In this case, the installation allows the generator to charge the batteries through the inverter capacity.

With an average of 5 days of running per month and considering the operating hours during each month, the generators have the following total consumption (Table 24):

Table 24. Total consumption of diesel generators

Month	Mar.	Apr.	May	June	July	Aug.	Sept.	Oct.	Nov.	Total
Hours	3	4	4	5	5	5	4	3	2	175
Days to operate	5	5	5	5	5	5	5	5	5	
CTM-60 L	85.95	114.6	114.6	143.25	143.25	143.25	114.6	85.95	57.3	1002.75
XS-GEN22kC	60	80	80	100	100	100	80	60	40	700

Optional, by changing the fix structure of PV panels to a structure with sun tracking system in both types of systems, the efficiency of the PV modules can raise by up to 40%. Adding a sun tracking system can cause different adjustments to each part of the installation in case of maintaining the PV structure. It is required more powerful equipment in order to manage the spare energy. Another solution is to reduce the size of the PV array.



# Budget and economic analysis



**Compilation of case studies of applying renewable energies to local development transnationally implemented**



Co-funded by the  
Erasmus+ Programme  
of the European Union



### 3. Economical aspects of the project

This chapter aims to provide all the economic data regarding the budget of the installation and payback of the installations presented in the previous chapter with the indication that the pump and the generator are provided by the contractor. The budget will be calculated with the remaining equipment.

Each system presents the cost of the PV module and the system cost named “balance of the system cost” (BOS cost) along with the economic indicator: payback, internal rate of return (IRR), net present value (NPV). Other aspect that influence the budget and the economic efficiency are the operational and maintenance (O&M) cost and the levelized cost of electricity (LCOE).

BOS cost includes the price of: designing the project, fees, equipment, structure, wires, preparation and assembly, combiner box, miscellaneous components and not least labour costs. Depending on the size, structure and site for small systems, the cost of BOS and installation fluctuate between 1 and 1.85 €/W. <sup>[42]</sup>

In consideration of cash flow, the economic indicators: payback, IRR and NPV reveal how long it will take to recover the finance and show the profitability of the investment comparing it with the cost of the actual system. However, the O&M cost have an influence over the budget. In general, the cost of O&M represents the third highest cost after capital investment and PV modules. A good plan of O&M reduces the risk of malfunction preventing distribution problems, annual degradation and equipment defection, giving the investors financial security. For each year, the O&M cost is calculated as 1.5 % of the initial investment. <sup>[43]</sup>

LCOE represent the method of comparison between two and/or more systems in order to see the economic reliability as well as the other economic indicators such as payback, IRR and NPV. The LCOE is calculated by using the following formula:

$$LCOE = \frac{I_0 + \sum_{t=1}^n \frac{M_t + F_t}{(1+r)^t}}{\sum_{t=1}^n \frac{E_t}{(1+r)^t}} \text{ (€/kWh)} \quad \text{Eq. (24)}^{[43]}$$

Where:

- $I_0$  - Investment;
- $M_t$  - operations and maintenance expenditures in year t;
- $F_t$  - fuel expenditures in year t, which is zero for photovoltaic electricity;
- $E_t$  - electricity generation in the year t;
- $r$  - discount rate;
- $n$  - investment period considered in years.

For further comparison, it is required to know the prices of PV Modules, main equipment (VFD, MPPT, batteries, inverter), structure, wires and auxiliary boxes (string box, protection box, grounding, DC cables, AC cables, etc), personal work (for installing the modules, structure, electric wiring and components, etc) and engineer design. These prices are provided

by Heliotec 2006 S.L. a Spanish SME from Castellón province.

### 3.1. Budget of the installation

The main price difference between the two installations is made by the larger number of components that demand more time for installing and more wires in order to connect but also by the time required to make all the steps of the installations.

As described in previous chapter, the main components have the following prices:

*Table 25. Prices of main components*

Product	Price per unit
PV module “Amerisolar AS-6P-310”	214
VFD “ISKUT SOLAR 425”	2210.68
MPPT “Schneider XW MPPT 80 600”	921.4
Battery “Tab + 12 OPzS 1500”	458.4
Inverter “Schneider Conext XW+ 5548 NA”	2375.24

For the initial investment of the first system, the size of the installation has to be considered as described in previous chapter to be made from 68 modules of 310 W/modules with a total of 21080 W, equipment prices from Table 25 and the following prices of the other BOS cost components leading to Table 26:

- 106.5 hours of work at 0.119 €/Wp divided in 13.3 days of work;
- design of installation at 2200 €;
- wires and auxiliary boxes at 0.264 €/Wp;
- structure at 50 €/module.

*Table 26. Initial investment of 21 kW system*

Product	Price per unit (€)	Total (€)
PV module	214 (68 modules)	14552
VFD	2210.68	2210.68
Structure	50	3400
Wires and auxiliary boxes	0.264	5565.12
Personal work	0.119	2508.52
Engineer design	2200	2200
Total	≈ 1.444 €/Wp	30436.32

For the second installation, the BOS cost has changed due to the addition of materials and hours needed to design the proper installation, as follows:

- 117.5 hours of work at 0.158 €/Wp divided in 14.7 days of work;
- design of installation at 2800 €; (≈ 0.174 €/Wp)
- wires and auxiliary boxes at 0.384 €/Wp;
- structure at 50 €/module.
- miniaturization display at 764.22 € (0.041 €/Wp)

Considering the installation made of 52 modules of 310 W leads to a total of 16120 W. Although using the data shown in the list above and equipments prices from Table 25, result the data presented in Table 27.

Table 27. Initial investment of 16 kW system

Product	Price per unit (€)	Total (€)
PV module	214 (52 modules)	11128
MPPT	921.4 (4 units)	3685.6
Batteries	458.4 (24 units)	11001.6
Inverter	2375.24 (3 units)	7125.7
Structure	50	2600
Monitoring display	764.22	764.22
Wires and auxiliary boxes	0.384 €/W <sub>p</sub>	6190.08
Personal work	0.158	2546.96
Engineer design	2800	2800
Total	≈ 2.968 €/W <sub>p</sub>	47842.16

In order to calculate the economic profitability, it is necessary to make an economic comparison between the actual system (AS), PV system with actual generator (PVAG) and the PV with the substitute generator (PVSG) for the next 20 years. In each case the economic indicators for the two available power of installation (21 kW and 16 kW) will be determined without any aid cost and price evolution due to uncertain evolution of prices that are influenced by many external factors as demand, competition between companies, oil reserve, worldwide politics, etc.

To have the economic comparison between the PV installations and the actual system, firstly the operational cost of the actual installation will be determined considering the actual price of the diesel fuel 1.120 €/litre, a consumption of 8.59 l/h and 1074 hour of running per year results:

$$1074 \times 8.59 \times 1.120 = 10332.74 \text{ €/year} \quad \text{Eq. (25)}$$

O&M cost for all system is estimated to be 1.5 % /year of the initial investment. From this consideration, the O&M cost for the systems is estimated as shown in Table 28.

Table 28. Estimated O&M cost per year

	21 kW system		16 kW system	
	Initial cost (€)	O&M (€/year)	Initial cost (€)	O&M (€/year)
PV module	14552	218.28	11128	166.92
VFD	2210.68	33.16	-	-
MPPT	-	-	3685.6	55.28
Batteries	-	-	11001.6	165.02
Inverter	-	-	7125.7	106.89
Wires, connection boxes and monitoring display	5565.12	83.48	6954.3	104.32

Structure	3400	51	2600	39
Total	25727.8	385.92	42495.2	637.43

In addition to the annual O&M cost, the backup generator adds an extra annual cost. Considering 175 hours of running of the actual generator at a consumption of 5.73 l/h and the price of fuel at 1.120 €/l, the annual fuel cost is estimated to be 1123.08 €/year. Furthermore, if the owner considers to change the generator with the one propose above (Figure 34) at a cost of 3108 €, the annual cost for fuel will decrease to 784 €/year. With an estimated O&M for the actual generator of 200 €, the annual costs for the next 20 year are:

Table 29. Actual generator cost in 20 years

Year	Energy consumption kWh	Actual generator (€)			
		€/ kWh	Fuel cost	O&M	Total cost
1	11770	0.878	10332.74	200	10532.74
2	11770	0.878	10332.74	200	10532.74
...	...	...	...	...	...
19	11770	0.878	10332.74	200	10532.74
20	11770	0.878	10332.74	200	10532.74
Total	235400	0.878	206654.8	4000	210654.8

Table 30. 21 kW PV panels cost in 20 years

Years	21 kW PV panels (€)				
	O&M cost	Fuel AG	Fuel SG	Total cost AG	Total cost SG
1	385.92	1123.08	784	1509	1169.92
2	385.92	1123.08	784	1509	1169.92
...	...	...	...	...	...
19	385.92	1123.08	784	1509	1169.92
20	385.92	1123.08	784	1509	1169.92
Total	7718.4	22461.6	15680	30180	23398.4

Table 31. 16 kW PV panels cost in 20 years

Years	16 kW PV panels (€)				
	O&M cost	Fuel AG	Fuel SG	Total cost AG	Total cost SG
1	637.43	1123.08	784	1760.51	1421.43
2	637.43	1123.08	784	1760.51	1421.43
...	...	...	...	...	...
19	637.43	1123.08	784	1760.51	1421.43
20	637.43	1123.08	784	1760.51	1421.43
Total	12748.6	22461.6	15680	35210.2	28428.6

Using the data from Table 29, Table 30 and Table 31 in equation 24, result the next LCOEs, depending on the type of installation (Table 32),  $r = 5\%$ :

Table 32. LCOE by system

LCOE	AS	21 kW PVAG	21 kW PVSG	16 kW PVAG	16 kW PVSG
€/kWh	0.895	0.338	0.506	0.743	0.684

From Table 32 it can be observed that for the levelized cost of electricity, the highest reliable price is made by the 21 kW PV panels system with values as 0.338 and 0.506 €/kWh

### 3.2. Payback, IRR and NPV

For calculating the economic indicators, the cash flow of the PV installation is needed. In our case, the cash flow represents the saved money as a difference between the annual cost of the generator and the annual cost of the PV installations (Table 33).

Table 33. Cash flow by system

Year	Actual cost (€)	Total cost of 21 kW PV panels (€)		Total cost of 16 kW PV panels (€)		Cash flow of 21 kW PV panels (€)		Cash flow of 16 kW PV panels (€)	
		AG	SG	AG	SG	AG	SG	AG	SG
0 (II)						-30436.32	-33544.32	-47842.16	-50950.16
1	10532.7	1509	1169.9	1760.5	1421.43	9023.74	9362.82	8772.23	9111.31
2	10532.7	1509	1169.9	1760.5	1421.43	9023.74	9362.82	8772.23	9111.31
...	...	...	...	...	...	...	...	...	...
19	10532.7	1509	1169.9	1760.5	1421.43	9023.74	9362.82	8772.23	9111.31
20	10532.7	1509	1169.9	1760.5	1421.43	9023.74	9362.82	8772.23	9111.31
Total	210655	30180	23398	35210	28428.6	150038	153712.08	127602.44	131276.04

Based on initial investment (II), annual cost and the cash flow from Table 33, we can establish the payback period of each installation (Table 34).

Table 34. Payback of installations

Year	Cash flow 21 kW (€)		Cash flow 16 kW (€)		Payback 21 kW (€)		Payback 16 kW (€)	
	AG	SG	AG	SG	AG	SG	AG	SG
0 (II)	-30436.32	-33544.32	-47842.16	-50950.16				
1	9023.74	9362.82	8772.23	9111.31	-21413	-24181.5	-39069.93	-41838.85
2	9023.74	9362.82	8772.23	9111.31	-12389	-14818.68	-30297.7	-32727.54
3	9023.74	9362.82	8772.23	9111.31	-3365.1	-5455.86	-21525.47	-23616.23
4	9023.74	9362.82	8772.23	9111.31	5658.64	3906.96	-12753.24	-14504.92
5	9023.74	9362.82	8772.23	9111.31	14682.4	13269.78	-3981.01	-5393.61
6	9023.74	9362.82	8772.23	9111.31	23706.1	22632.6	4791.22	3717.7
7	9023.74	9362.82	8772.23	9111.31	32729.9	31995.42	13563.45	12829.01
8	9023.74	9362.82	8772.23	9111.31	41753.6	41358.24	22335.68	21940.32
9	9023.74	9362.82	8772.23	9111.31	50777.3	50721.06	31107.91	31051.63
10	9023.74	9362.82	8772.23	9111.31	59801.1	60083.88	39880.14	40162.94
11	9023.74	9362.82	8772.23	9111.31	68824.8	69446.7	48652.37	49274.25



12	9023.74	9362.82	8772.23	9111.31	77848.6	78809.52	57424.6	58385.56
13	9023.74	9362.82	8772.23	9111.31	86872.3	88172.34	66196.83	67496.87
14	9023.74	9362.82	8772.23	9111.31	95896	97535.16	74969.06	76608.18
15	9023.74	9362.82	8772.23	9111.31	104920	106897.98	83741.29	85719.49
16	9023.74	9362.82	8772.23	9111.31	113944	116260.8	92513.52	94830.8
17	9023.74	9362.82	8772.23	9111.31	122967	125623.62	101285.75	103942.11
18	9023.74	9362.82	8772.23	9111.31	131991	134986.44	110057.98	113053.42
19	9023.74	9362.82	8772.23	9111.31	141015	144349.26	118830.21	122164.73
20	9023.74	9362.82	8772.23	9111.31	150038	153712.08	127602.44	131276.04

In conclusion, Table 34 presents the necessary time of each system in order to be economically profitable (ordered by reliability):

- 21 kW PVAG - 4 years (5658.64 € profit);
- 21 kW PVSG - 4 years (3906.96 € profit);
- 16 kW PVAG - 6 years (4791.22 € profit);
- 16 kW PVSG - 6 years (3717.70 € profit).

Moreover, at the end of the 20 years of evaluation, because of the differences between costs and cash flow, the values showed different reliability of the installations:

- 21 kW PVSG - 153712.08 € profit;
- 21 kW PVAG - 150038.00 € profit;
- 16 kW PVSG - 131276.04 € profit;
- 16 kW PVAG - 127602.44 € profit.

To determine the  $NPV_0$  of the systems, we will take in consideration the discount rate of 5 % as IRR. In conclusion, by replacing the values in Eq. 26 we can calculate the NPV for each year to establish the profitability of the systems (Table 35).

$$NPV_0 = -I_0 + \sum_{t=1}^n \frac{C_t}{(1+r)^t} \text{ (€)} \quad \text{Eq. (26)}^{[43]}$$

Where:

$NPV_0$  - Net present value of the project

$C_t$  - cash flow to be received in period t

n - number of total periods for discounting or the expected years of life of the project

r - discount rate (i.e. required rate of return)

t - number of period during which the discounting occurs

$I_0$  - initial outlay (or the cash flow at  $t_0$ )

Table 35. Payback vs. NPV of installations

Year	Payback 21 kW (€)		Payback 16 kW (€)		NPV 21 kW (€)		NPV 16 kW (€)	
	AG	SG	AG	SG	AG	SG	AG	SG
0 ( $I_0$ )	-30436.32	-33544.32	-47842.16	-50950.16				
1	-21413	-24181.5	-39069.93	-41838.85	-21842.28	-24627.35	-39487.66	-42272.72
2	-12389	-14818.68	-30297.7	-32727.54	-13657.48	-16134.99	-31530.98	-34008.5
3	-3365.1	-5455.86	-21525.47	-23616.23	-5862.44	-8047.04	-23953.2	-26137.8

4	5658.64	3906.96	-12753.24	-14504.92	1561.42	-344.22	-16736.27	-18641.91
5	14682.4	13269.78	-3981.01	-5393.61	8631.75	6991.79	-9863	-11502.96
6	23706.1	22632.6	4791.22	3717.7	15365.41	13978.47	-3317.02	-4703.96
7	32729.9	31995.42	13563.45	12829.01	21778.41	20632.45	2917.24	1771.28
8	41753.6	41358.24	22335.68	21940.32	27886.03	26969.58	8854.63	7938.18
9	50777.3	50721.06	31107.91	31051.63	33702.81	33004.93	14509.29	13811.41
10	59801.1	60083.88	39880.14	40162.94	39242.61	38752.89	19894.68	19404.96
11	68824.8	69446.7	48652.37	49274.25	44518.60	44227.14	25023.62	24732.16
12	77848.6	78809.52	57424.6	58385.56	49543.36	49440.71	29908.32	29805.67
13	86872.3	88172.34	66196.83	67496.87	54328.84	54406.01	34560.42	34637.6
14	95896	97535.16	74969.06	76608.18	58886.44	59134.87	38991	39239.43
15	104920	106897.98	83741.29	85719.49	63227.02	63638.55	43210.59	43622.12
16	113944	116260.8	92513.52	94830.8	67360.89	67927.77	47229.25	47796.12
17	122967	125623.62	101285.75	103942.1	71297.92	72012.73	51056.54	51771.35
18	131991	134986.44	110057.98	113053.42	75047.47	75903.18	54701.59	55557.29
19	141015	144349.26	118830.21	122164.73	78618.47	79608.36	58173.05	59162.95
20	150038	153712.08	127602.44	131276.04	82019.43	83137.11	61479.22	62596.90

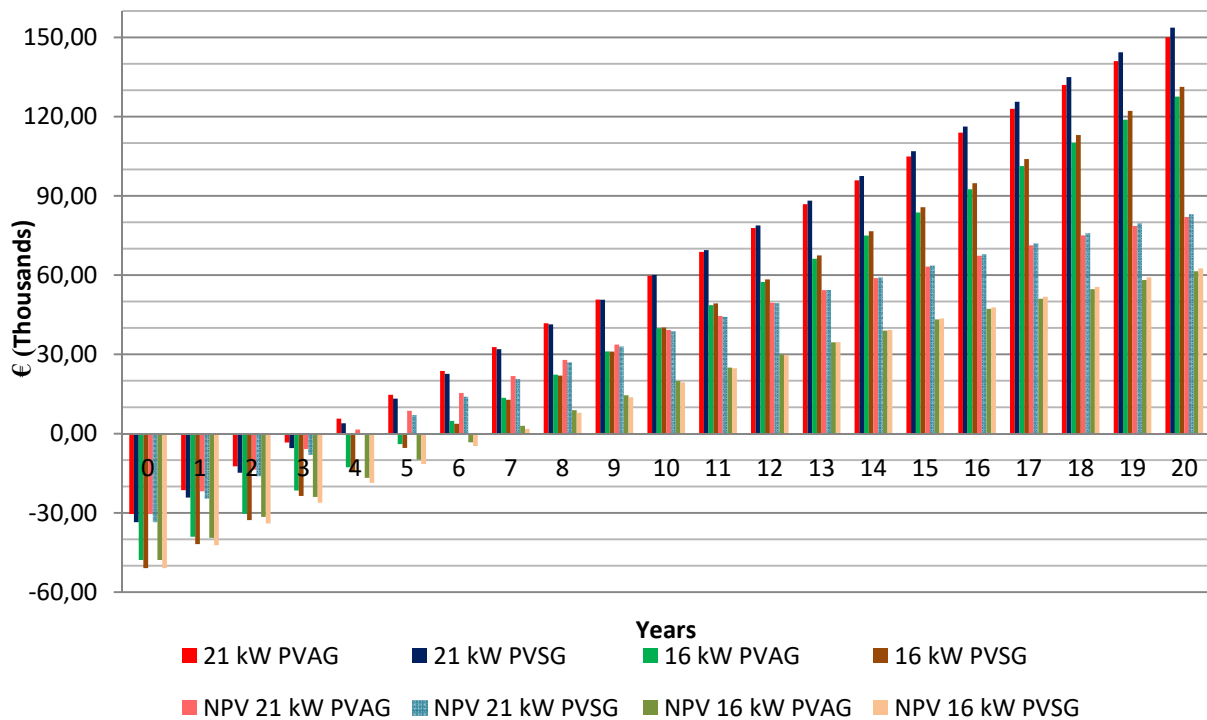

Figure 42. Payback vs. NPV of installations

In equally significant aspect as Table 35, Figure 42 presents the differences between the systems. For the NPVs of the systems, the economic benefits start to appear in:

- 21 kW PVAG - 4 years (1561.42 € profit);
- 21 kW PVSG - 5 years (6991.79 € profit);
- 16 kW PVAG - 7 years (2917.24 € profit);
- 16 kW PVSG - 7 years (1771.28 € profit).

As specified above, the systems present a different order for the NPV values as the payback at the end of the 20 years:

- 21 kW PVSG - 83137.11 € profit;
- 21 kW PVAG - 82019.43 € profit;
- 16 kW PVSG - 62596.90 € profit;
- 16 kW PVAG - 61479.22 € profit.

The internal rate of return (IRR) for each system for the installations is shown in Table 36:

*Table 36. Internal rate of return*

IRR %	21 kW PV panels		16 kW PV panels	
	AG	SG	AG	SG
	28.24	26.58	17.46	17.03

Despite the technical differences of the systems, each one has proved to be economically efficient due to the high contrast between actual system cost and the predicted cost of the photovoltaic installations.



# Project plans



**Compilation of case studies of applying renewable energies to local development transnationally implemented**



Co-funded by the  
Erasmus+ Programme  
of the European Union





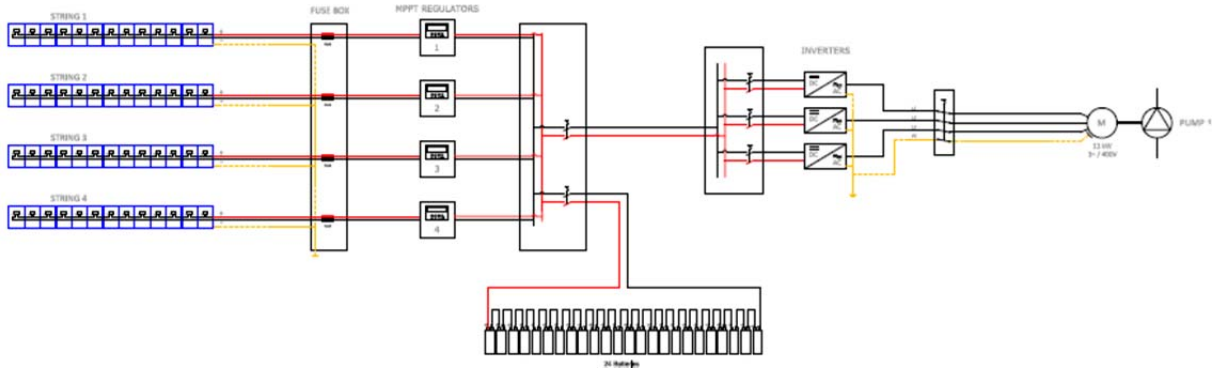

Figure 45. 2'nd Installation Electric Scheme

In Figure 45, the generator can be connected between the inverters and the pump, in order to simplify the circuit.



Co-funded by the  
Erasmus+ Programme  
of the European Union