

# Guide on renewable energies for small rural municipalities

Authors: Isabel Giménez, Pablo Giménez and Leonor Hernández

Collaborator: Juan José Mayans



Co-funded by the  
Erasmus+ Programme  
of the European Union



**GEOLIN**

**GENERAL ELECTRIC**

Date and place of edition:  
August 2017, Castellón de la Plana (Spain)

Authors:  
Isabel Giménez, Pablo Giménez and Leonor Hernández

Collaborator:  
Juan José Mayans

English revision by:  
Elena Ciobanu and Noémi Fiser

Front cover images:  
Mas Torre Martínez in Vistabella del Maestrazgo (Spain), Isabel Giménez  
Panoramic view of Serra (Spain), Municipality of Serra

Figures under a Creative Commons license:

Fig. number	Source	Fig. number	Source
5	Microsoft (2010)	39	Intech Open Science (n.d.)
6	TutorVista (n.d.)	40	Solar Wiki (n.d.)
7	Futurism (n.d.)	42	Wind Up Battery (n.d.)
8	Wikimedia (n.d.)	43	Alternative Energy Tutorials (n.d.)
9	Scripts Mit (n.d.)	44	Wikimedia (n.d.)
28	Electrical easy (n.d.)	46	Imprint (n.d.)
32	Turbines Info (n.d.)	49	Wikimedia (n.d.)
37	Perso Numericable (n.d.)	54	Steamgreen (n.d.)



CC BY-NC-SA

This licence allows others remix, transform, or build upon the material without commercial purposes, giving appropriate credit and distributing their contributions under the same license as the original.

DOI: <http://dx.doi.org/10.6035/IN2RURAL.2017.05>

The PDF version of this document is available in:

<http://in2rural.uji.es/>, <http://in2rural.ub.ro/> and <http://repositori.uji.es/xmlui/handle/10234/154485>

*The European Commission support for the production of this publication does not constitute an endorsement of the contents which reflects the views only of the authors, and the Commission cannot be held responsible for any use which may be made of the information contained therein.*



## ACKNOWLEDGEMENTS

We would like to thank to the following organisations and individuals for the support they have provided in making this guide happen:

### *LOCAL GOVERNMENTS*

Ajuntament de Benlloch

Ajuntament de Serra

### *EDUCATIONAL CENTRES*

Escuela Municipal de Educación Infantil de Serra (Serra Municipal Nursery)

### *ENTERPRISES*

Baiwind

ENAIR

### *INDIVIDUALS*

Ximo Arnal

Xavier Ginés

Marta Rodríguez

Jose Ros

Lara Utrilla



## INDEX

<b>INTRODUCTION</b> .....	8
<b>FIRST PART. APPROXIMATION TO RURAL DEVELOPMENT AND RENEWABLE ENERGIES</b>	
1. RURAL DEVELOPMENT .....	9
1.1. Concept and characteristics .....	9
1.2. Institutional framework .....	10
1.3. Local actors .....	11
1.4. Participation .....	12
1.5. The project cycle .....	13
1.6. Contributions of renewable energy to rural development .....	17
2. RENEWABLE ENERGY TECHNOLOGIES .....	18
2.1. Introduction to energy technology .....	18
2.1.1. Energy and power .....	18
2.1.2. Sources of energy .....	19
2.1.3. Thermal energy, heat and temperature .....	19
2.1.4. Mechanical energy .....	21
2.1.5. Electric power .....	21
2.1.6. Coupling of generators and electrical accumulators .....	25
2.1.7. Energy, power, efficiency and consumption .....	26
2.2. Renewable energies from a local perspective .....	27
2.2.1. Biomass and biogas .....	27
2.2.2. Mini hydraulic .....	32
2.2.3. Small wind .....	35
2.2.4. Thermal solar energy .....	39
2.2.5. Photovoltaic solar energy .....	44
<b>SECOND PART. BEST PRACTICE IN RURAL ENERGY TRANSITION: BIOMASS MANAGEMENT FOR RURAL DEVELOPMENT IN SERRA</b>	
3. KNOWING THE CONTEXT: THE MUNICIPALITY OF SERRA .....	50
4. THE BIOMASS PROJECT IN A NUTSHELL .....	52
5. DETAILS OF THE MUNICIPAL NURSERY HEATING INSTALLATION .....	53
6. IMPACTS OF THE BIOMASS PROJECT .....	60
REFERENCES .....	62



**FIGURE INDEX**

Figure 1. Dimensions of sustainable development adapted to renewable energy projects ..... 9

Figure 2. Covenant of Mayors for Climate and Energy: Multi-stakeholder involvement ..... 10

Figure 3. The participation ladder ..... 12

Figure 4. Project cycle management ..... 14

Figure 5. Force, displacement and work ..... 18

Figure 6. Thermometric scales and reference points ..... 20

Figure 7. Heat transfer ..... 20

Figure 8. Tetrahedron of fire ..... 21

Figure 9. Mechanical energy ..... 21

Figure 10. Ohm's Law ..... 22

Figure 11. Four-wire distribution ..... 23

Figure 12. Alternator ..... 23

Figure 13. Three-phase autotransformer 400/230 V ..... 23

Figure 14. Single-phase rectifier ..... 24

Figure 15. Accumulator battery ..... 24

Figure 16. Submersible heating resistors ..... 25

Figure 17. Coupling of accumulators in serial connection ..... 25

Figure 18. Coupling of accumulators in parallel connection ..... 25

Figure 19. Coupling of accumulators in serial-parallel ..... 26

Figure 20. Parameters of an electric motor ..... 26

Figure 21. Parameters of a thermal generator ..... 26

Figure 22. Parameters of a heat pump ..... 27

Figure 23. Pellets ..... 27

Figure 24. Automatic polyifuel boiler ..... 28

Figure 25. Underfloor heating ..... 29

Figure 26. Basic heating and SHW installation with biomass ..... 29

Figure 27. Biodigester ..... 30

Figure 28. Dam power plant ..... 32

Figure 29. Flowing water plant ..... 32

Figure 30. Micro Hydro-turbine Installation ..... 33

Figure 31. Distribution of flows ..... 34

Figure 32. Pelton turbine ..... 35

Figure 33. Horizontal wind turbine with rotor to windward ..... 35

Figure 34. Variation of the efficiency of a wind turbine with the height ..... 36

Figure 35. Zone of turbulence caused by an obstacle ..... 37



Figure 36. Anemometer with data acquisition .....	37
Figure 37. Power density ( $A = 1 \text{ m}^2$ ) .....	38
Figure 38. Small wind installation diagram .....	39
Figure 39. Solar spectrum .....	39
Figure 40. Distribution of solar radiation .....	40
Figure 41. Solarimeter GIS R403 .....	40
Figure 42. Flat solar collector .....	41
Figure 43 Parabolic collector .....	41
Figura 44. Azimuth .....	42
Figure 45. Water heating with accelerator pump .....	42
Figure 46. Efficiency curves of a high performance collector .....	43
Figure 47. Curves of generated and demanded power .....	43
Figure 48. Irradiance and peak solar hours .....	44
Figure 49. Photovoltaic cell .....	45
Figure 50. Stationary lead-acid battery .....	47
Figure 51. Isolated installation with charge regulator and inverter .....	48
Figure 52. Water pump system with frequency inverter .....	48
Figure 53. Switching installation for water pumping equipment .....	49
Figure 54. Wind-photovoltaic hybrid systems with photovoltaic modules, wind turbine and generator set .....	49
Figure 55. Panoramic of Serra .....	50
Figure 56. Biomass storage .....	52
Figure 57. Municipal nursery .....	52
Figure 58. Pellet production .....	53
Figure 59. Serra produced pellet .....	53
Figure 60. Nursery orientation .....	53
Figure 61. Boiler room .....	53
Figure 62. Diagram of the installation .....	54
Figure 63. Poly-fuel boiler .....	56
Figure 64. Rooms with direct heating .....	57
Figure 65. Radiator .....	58
Figure 66. Radiator in the nursery .....	58
Figure 67. Distribution of radiators .....	58
Figure 68. Construction with sandwich panels (wood, rockwool and wood) .....	59
Figure 69. Insulated windows (double glazed) .....	59
Figure 70. Room .....	59



Figure 71. Open air area .....	59
Figure 72. Serra city council .....	61
Figure 73. Juan Jose Mayans (municipal engineer) and Jose Ros (biomass operator) .....	61



## TABLE INDEX

Table 1. Concept note template .....	14
Table 2. Relation between power, voltage and current in direct current .....	22
Table 3. Energy stored in a battery with a charge of 100% .....	24
Table 4. Thermal power density in W/m <sup>2</sup> required in rural housing .....	29
Table 5. Retention time according to temperature .....	31
Table 6. Daily fresh manure production .....	31
Table 7. Biogas production .....	31
Table 8. Energy equivalents of biogas .....	31
Table 9. Output power of a microturbine according to flow and height of the water jump ...	33
Table 10. Wind speed with respect to the one determined at 10 meters height .....	37
Table 11. Technical characteristics of a photovoltaic panel .....	45
Table 12. Consumption table .....	46
Table 13. Data about the location and demography of Serra .....	51
Table 14. Active enterprises in 2016 (except primary sector) .....	51
Table 15. Thermal power density .....	55
Table 16. Constructed area of the building .....	55
Table 17. Thermal power in rooms with direct heating .....	56
Table 18. Selection of radiators .....	59





## INTRODUCTION

**Sustainable energy and climate action** are critical for European Union local and regional authorities, who have voluntarily assumed the commitment to implement the EU's objectives on their territories through The Covenant of Mayors for Climate and Energy. This bottom-up initiative, which started in 2015, looks forward to decarbonised, resilient and efficient cities. To this end, it establishes the target of decreasing at least 40% of the CO<sub>2</sub> emissions by 2030, through greater use of renewable energy sources and improved energy efficiency measures.

At the same time, the **depopulation of rural areas** (90% of the EU's land mass) is one of the most relevant changes for policy makers. In fact, demographic changes are directly associated to the problem of young people moving towards bigger towns due to the lack of opportunities (jobs, services, infrastructure) in the countryside. Although in the rural areas there is a high potential to promote renewable energies, the lack of information and the limited dissemination of best practices make it difficult for small municipalities to take advantage of the possible benefits of a viable energy model.

Taking into account both challenges (energy transition and preventing population from leaving), this guide<sup>1</sup> aims at supporting local initiatives that generate new opportunities for the **socioeconomic development of small rural areas through renewable energies**. To achieve it, three specific objectives have been established:

- ✓ To support the local governments in the design of strategies and action plans.
- ✓ To strengthen the skills and competences of local development actors.
- ✓ To raise awareness among the civil society by creating a renewable energy friendly atmosphere.

Taking into account the relevance of the different organisations that contribute to the improvement of the living conditions in the rural area, the **target audience** of this document is composed of local governments and diverse actors that are active in the daily functioning of the territories. Some of these actors are agricultural cooperatives, small and medium enterprises, educational centres, Local Action Groups (LAG) and civil society organisations.

The **methodology** used to prepare the guide includes not only a theoretical review, but also fieldwork in rural areas by means of qualitative techniques, especially semi-structured interviews. The preliminary version of the document has also been presented in two public events in Spain (Castellón de la Plana and Vistabella del Maestrat, June 2017) where the audience - local and regional governments, enterprises, universities, rural population, etc. - have provided suggestions and comments that have been integrated in the final version.

From an interdisciplinary perspective, the **contents of the guide** are structured in two main parts: an introduction to rural development and renewable energies and the analysis of one of the best practices in rural energy transition. The first part includes general introductory concepts such as sustainability, participation, project cycle management, measurement units and renewable energies for rural development. The second part contains a description of the biomass management in Serra, a small municipality located in the Valencian Region (Spain).

---

1. This guide has been developed in the framework of the Erasmus+ project IN2RURAL, which aims to promote innovative practices in the renewable energies sector improving the employability of university students in the rural areas of Bacău (Romania), Castellón (Spain) and Heves (Hungary). More information available at <http://in2rural.ub.ro> and <http://in2rural.uji.es/>



# FIRST PART

## APPROXIMATION TO RURAL DEVELOPMENT AND RENEWABLE ENERGIES

### 1. RURAL DEVELOPMENT

#### 1.1. CONCEPT AND CHARACTERISTICS

Rural development can be defined as the *"the process of a balanced and self-sustaining revitalization of the rural world based on its economic, social and environmental potential through a regional policy and an integrated application of measures with territorial basis by participatory organizations"* (Quintana et al., 1999).

According to this definition, the main characteristics of renewable energy projects oriented towards rural development are:

- **Multi-sectorial** approach, taking into account the primary sector of the economy (agriculture, forestry, fishing...), the production of goods and the services.
- **Endogenous** development based on the particularities of the context and the valorization of the local values.
- **Interdisciplinary** activities and policies that combine social, economic, environmental, cultural and institutional aspects.
- Relevance of the **local initiatives** in which the rural actors take the initiative and participate actively.
- Interdependence with **environmental** conservation and improvement, which can be linked with economic viability.

The Figure 1 schematises the variables that need to be considered by any renewable energy project from a sustainable perspective.

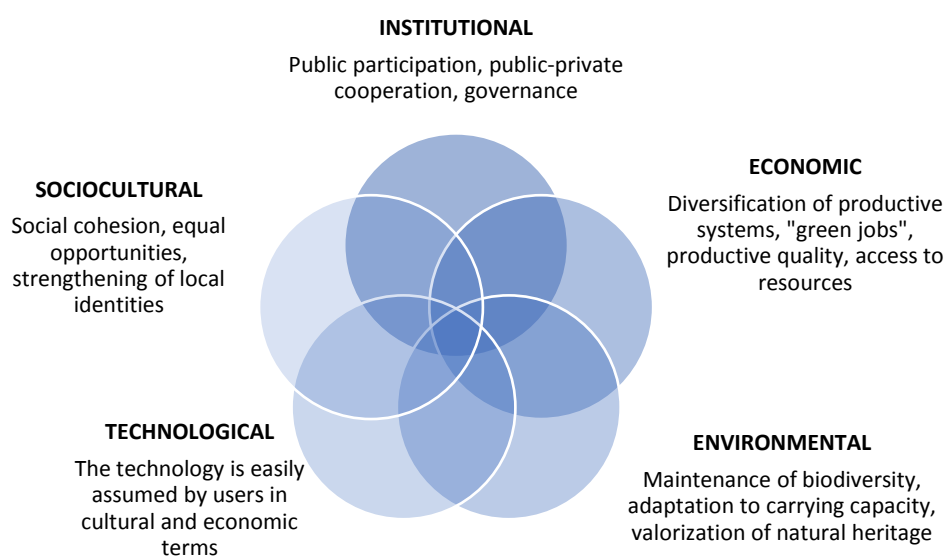

Figure 1. Dimensions of sustainable development adapted to renewable energy projects. Source: Own elaboration



## 1.2. INSTITUTIONAL FRAMEWORK

There are different initiatives, strategies and policies that address the relationship between energy and sustainability. At international level, the link between renewable energies and development is supported by two global initiatives promoted by the United Nations Organization:

- **Sustainable Development Goals**, adopted in September 2015, to end poverty, protect the environment and ensure prosperity for all (UN, 2015 a). Two of the seventeen goals are directly related to the aim of this guide:
  - ✓ Goal 7: Ensure access to affordable, reliable, sustainable and modern energy for all
  - ✓ Goal 13: Take urgent action to combat climate change and its impacts
- **The Framework Convention on Climate Change**, entered into force on 1994 with the aim of preventing “dangerous” human interference with the climate system. The **Paris Agreement** builds upon the Convention and its central aim is “to strengthen the global response to the threat of climate change by keeping the global temperature rise this century well below 2 degrees Celsius above pre-industrial levels” (UN, 2015 b).

As it has been mentioned in the introduction of this guide, the **Covenant of Mayors for Climate and Energy** brings together local and regional governments committed to applying European Union climate and energy objectives from a multi-stakeholder perspective (see Figure 2). To deliver practical actions, the signatories of the Covenant - villages, towns, cities, counties - submit a Sustainable Energy and Climate Action Plan with specific measures for increasing energy efficiency and the use of renewables.

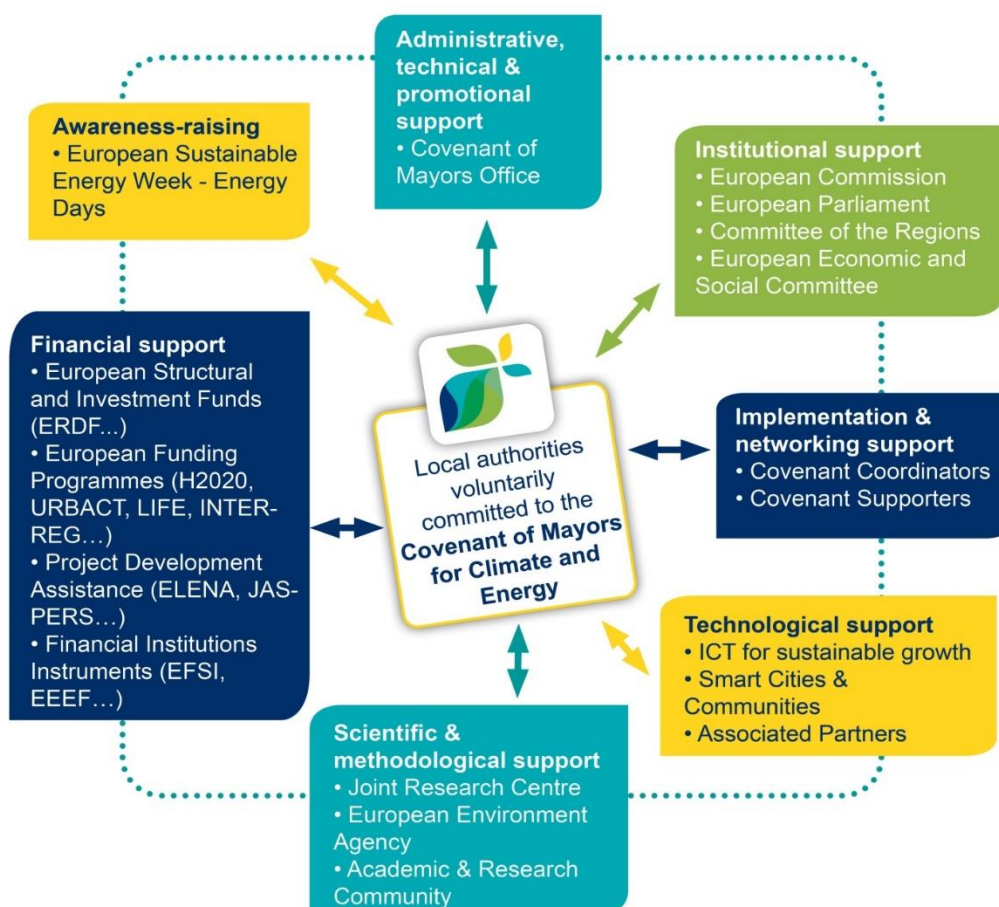

Figure 2. Covenant of Mayors for Climate and Energy: Multi-stakeholder involvement.  
Source: Covenant of Mayors for Climate & Energy (2016)



Under the **European Renewable Energy Directive**<sup>2</sup>, individual EU countries have prepared **National Renewable Energy Action Plans** based on their specific available resources and energy markets. These plans include policy measures and specific guidelines for rural areas to achieve national targets through the cooperation between local, regional and national authorities.

The **bottom-up approach**, consisting in the participation of local actors in decision-making about the strategy and the priorities, should be combined and interact with the above mentioned laws, directives and guidelines, in order to obtain the expected overall results.

### 1.3. LOCAL ACTORS

To integrate rural development and renewable energies, an interrelation between different stakeholders with complementary competences and experiences is necessary. Thus, a collaboration among population, economic and social interest groups and public and private institutions is desirable. The main stakeholders and their possible roles in renewable energy projects are:

- **Local governments** coordinate initiatives and promote regulations that facilitate the use of renewable energies. In addition, municipal installations of renewable energies have a multiplier effect not only in the village but also in the near towns.
- **Educational and research centres** include renewable energies in their teaching offer and carry out studies to generate knowledge about the local situation. Family involvement in children's education facilitates awareness among the community.
- **Private sector** is the key for the economic sustainability of the territory and in rural areas it is mainly composed of micro and medium enterprises, such as agricultural cooperatives and biomass producers.
- **Mass media** that contribute to the training and information of the citizenship and may cover the population at large. This contributes to the creation of a conducive environment for the development of renewable energy projects.
- Others, such as professional organisations and unions, trade associations, residents and their local organisations, cultural and community service providers, women's associations and young people.

One of the strategies that facilitate the collaboration of different stakeholders is the establishment of **Local Action Groups (LAGs)**, as proposed by the European LEADER Association for Rural Development. The LAGs integrate public and private partners and should be representative of local interests groups. In this participatory model, the private partners and associations form a minimum 50% of the local partnership. Some of the strengths of LAGs are that they combine different sources of human and financial resources, bring local players around collective projects and create a culture of dialogue and cooperation between rural actors (preventing potential conflicts).

Another proposal to facilitate the stakeholder organisation is provided by EURO-SOLAR (2013). According to this project, a rural renewable energy project will count on the participation of:

- Coordination Cells, in charge of the coordination and supervision of the activities and with providing the funds and resources.
- A Monitoring Committee for project supervision.
- A Local Community Organisation legally constituted and with competences to administer the project resources.

---

<sup>2</sup> Directive 2009/28/EC of the European Parliament and of the Council of 23 April 2009 on the promotion of the use of energy from renewable sources and amending and subsequently repealing Directives 2001/77/EC and 2003/30/EC



- Specialized Technological Assistance, provided by people highly experienced in renewable energy technologies.

## 1.4. PARTICIPATION

**Participation** can be defined as a process by which communities or different social sectors, especially those marginalized or excluded, with legitimate interests in a project, program or development policy, influence the latter and are involved in decision making and resource management, being actors of their own development (Murguialday, 2006).

When promoting rural development by using renewable energies, it is essential that the interest groups take part in all the phases of the process. This approach highlights the value of **local traditional knowledge** and facilitates the sustainability of the projects even if external support ends.

Taking into account that participation is considered as a process, people become gradually involved in the stages of a renewable energy project, transforming the community from a passive spectator into the engine of its own development. According to Geilfus (2008), this process can be represented through a stair (see Figure 3), where the different steps are:

- **Passivity.** People only participate when they are told, but they do not have influence on decisions.
- **Information providers.** People give data and express their opinions through different techniques, such as interviews, but they can not influence the use of the information.
- **Consultative participation.** Although people are consulted by external actors, they are not involved in the decisions made based on the analysis of the consultation.
- **Incentive-based participation.** People take part by supplying resources in exchange for some incentive (for example, they lend land for demonstrative installations).
- **Functional participation.** Even though people are not involved in the initial design of the project, they participate in the achievement of the predefined project goals.
- **Interactive participation.** People, usually organized in local groups, participate in project design, implementation, follow up and evaluation.
- **Self-development.** Local people lead the initiative and coordinate the support of external parties, who assume the role of accompaniment.

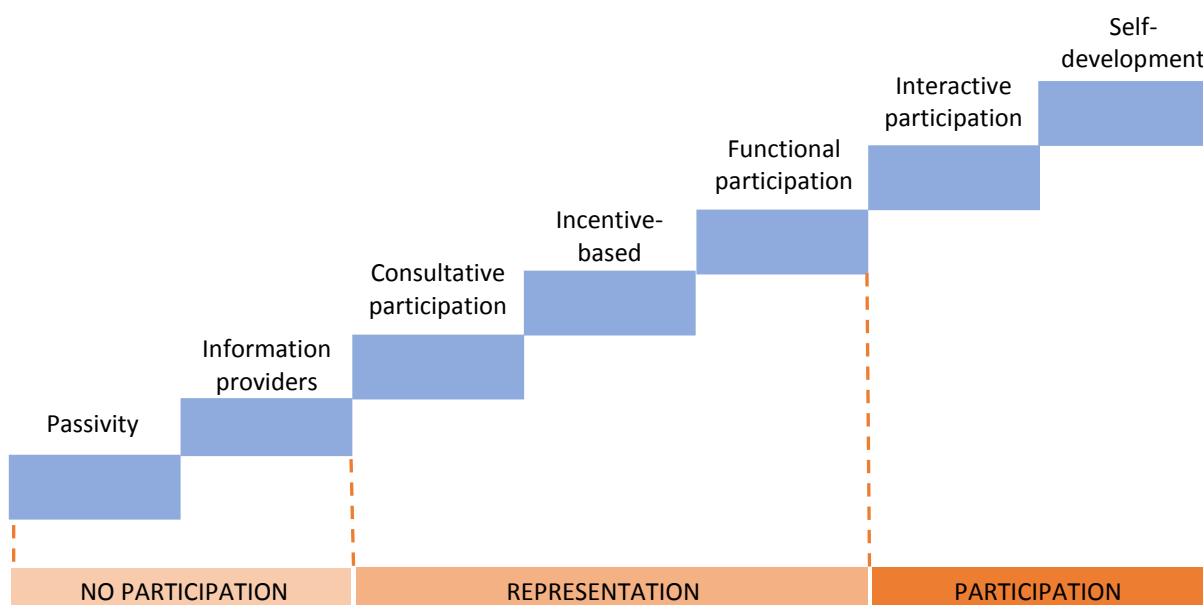

Figure 3. The participation ladder. Source: Own elaboration based on Geilfus (2008)



As it has been mentioned, national and/or regional guidelines on renewable energies should be combined with a bottom-up approach, which is necessarily based on the recognition and reinforcement of local capacities through bidirectional teaching/learning. As it is suggested by the European LEADER Association for Rural Development (n.d.) the **capacity building** involves:

- Awareness raising, training, participation and mobilisation of the local population to identify the strengths and weakness of the area (analysis);
- Participation of different interest groups in drawing up a local development strategy;
- Establishment of clear criteria for selection at local level of appropriate actions (projects) to deliver the strategy.

The justification of using a participatory approach in rural renewable energy projects is mainly ethical, but it also helps in obtaining better outputs for the criteria that are habitually used to evaluate development projects (Arnanz, 2011):

- **Relevance:** the adequacy of objectives and results to the context. With a participatory process the relevance is greater because the objectives and results respond to a social demand which is real. In addition, participatory processes favour better contact and knowledge of the physical and social context.
- **Efficiency:** the optimal relationship between achieved results and dedicated resources. The participatory processes, although slower, prove to be more effective because they are supported by deep analysis and reflection, in addition to having higher social acceptance.
- **Efficacy:** the achievement of the objectives. In participatory processes, the probability of success is bigger due to the fact that the motivation and the level of cooperation and involvement is stronger than in traditional top to bottom models.
- **Impact:** the impact or effect produced by a participatory process is greater, since the participation is supported by, among other things, higher levels of information, transparency and dissemination.
- **Viability and sustainability:** actions planned following a community's reflection process combine the technical knowledge provided by external specialists with the experiential knowledge of a community in permanent interaction with its environment and resources. Once the external support ends, its continuation is only possible if the population see the project and results as their own (appropriation).
- **Coherence:** the participatory processes aim to establish consensus and alliances that facilitate the communication and interaction between socioeconomic actors. This is fundamental because it ensures that the development project is consistent with the existing initiatives.

## 1.5. THE PROJECT CYCLE

A rural renewable energy project consists of a series of activities aimed at bringing about clearly specified objectives within a defined time-period and with a defined budget (European Commission, 2004). The cycle for managing projects has different phases, outlined in Figure 4.

Although the project cycle management is commonly used in rural development, it is essential to consider some of the risks that may be associated to this methodology. If renewable energy projects are run by means of a top-down approach, it can be difficult for the rural population to assume the ownership of the projects and the adaptation to the financing rules of the donor may undermine local structures. To minimize this risk, project cycle management needs the **active participation of key stakeholders** and should be based on a well-informed decision-making.



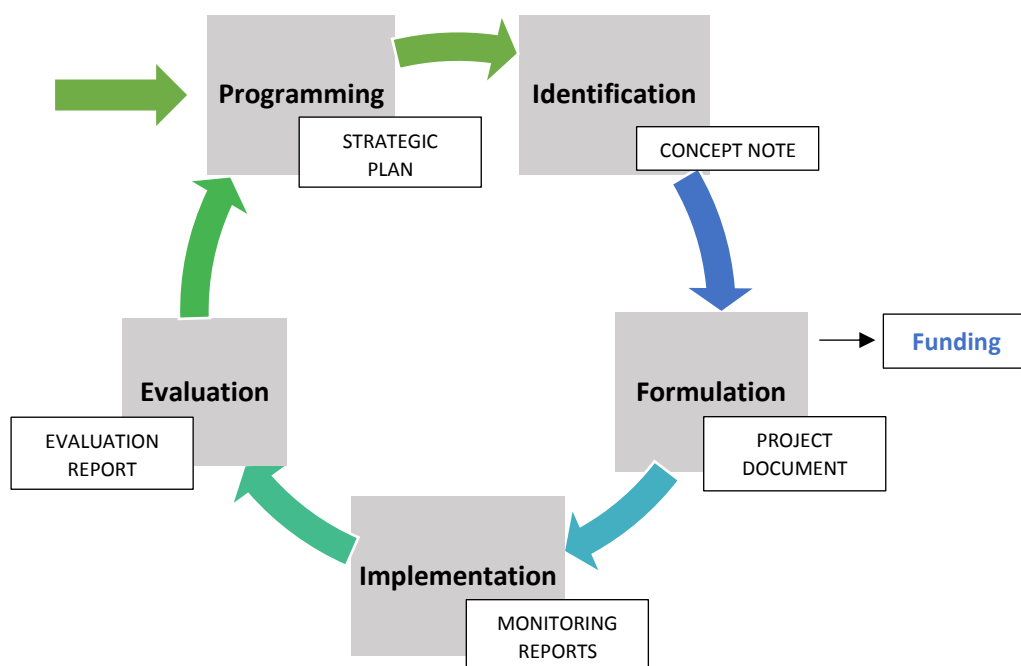

Figure 4. Project cycle management. Source: Own elaboration based on European Commission (2004)

## PHASE 0. PROGRAMMING

The project should be coherent with the programming documents at broader levels, taking into consideration the local, regional, country, European and international strategies regarding renewable energies and rural development. In this phase, the promotion of the **local appropriation of the strategy** is a key factor in the facilitation of an adequate implementation. The programming allows an initial identification of stakeholders, problems to solve and lessons learned from previous experience.

## PHASE 1. IDENTIFICATION

The identification stage is characterised by the **initial analysis** of the interest groups (direct and indirect), the existing problems, the desired objectives and the alternatives to achieve them. There are different methodologies to carry these analyses out, but it is recommendable to use **participatory tools** that facilitate the involvement of the population. Some of the techniques that can be applied to rural renewable energies are the vulnerability/capacity analysis, the Venn diagram, the social map, the problem and objective tree and the SWOT (Strengths, Weaknesses Opportunities, Threats) analysis.

One of the deliverables of this phase is a **concept note** (see Table 1) that summarizes the preliminary components of the project. This document is the result of the participatory work carried out with the community and will be the basis for the next phase.

Table 1. Concept note template (Recommended maximum length: five pages). Source: Adapted from FAO (2012)

<b>PROJECT TITLE:</b>	
Place of implementation:	
Estimated budget (or range):	
Possible start and end date:	
<b>1. BACKGROUND</b>	
1.1. Contribution to regional, country and European frameworks:	
1.2. Contribution to local framework:	



2. SUMMARY OF PROPOSED PROJECT	
2.1. Problem(s) to be addressed	
2.2. Summary of the proposed strategy	
2.3. Expected results	
2.4. Participants and other stakeholders	
2.5. Potential risks	
2.6. Sustainability of the proposal	
2.7. Synergies	
3. IMPLEMENTATION ARRANGEMENTS	
3.1. Partner(s)	
3.2. Prospective funding source(s)	
3.3. Project task force	

## PHASE 2. FORMULATION

This phase consists of the in-depth analysis of all the components and includes detailed and specific information about:

- **Objectives** to achieve through the implementation of the rural renewable energy project. They are fruit of the previous need analysis and are the central point of reference. The objectives should be clear, viable, relevant and limited in time.
- **Outputs** needed to complete the objectives. They are a combination of products and services delivered by the project, both during and after its execution.
- **Activities**, defined as the tasks that are carried out to obtain the outputs. The list of activities is the basis of the action plan and each activity is associated to the dedication and resources required for its performance.
- **Indicators** that allow the verification of the project achievement and give information about quantity, quality and time. For this reason, they are essential for monitoring and evaluation.
- **External risks** that may affect the project at different levels (environmental, economical, institutional, social, political...) and need to be minimized with appropriate contingency measures.

The above mentioned data will be organized in a **project form**, which final format will depend on the purpose of the document. For example, if the project is going to be presented to a funding agency, it is probable that the agency will provide a specific application form. The **funding or co-funding** of the project may come from different sources, such as European institutions, national organisations, regional and/or local governments, private organisations, public-private partnerships...

## PHASE 3. IMPLEMENTATION AND MONITORING

This is the stage in which **results are delivered** and **specific goal(s) are achieved**. To this end, resources should be efficiently managed and advances need to be monitored and reported. According to the European Commission (2004), implementation is structured in three main periods:

- 1) Inception, which includes aspects such as contracting arrangements, resource mobilisation, revision of the project plan and inception workshop(s).
- 2) Implementation of activities and result delivery, with monitoring and reporting of progress.





- 3) Progressive transference of the project to local partners through maintenance plans, skills transmission and support for the economic viability.

During implementation, different supporting **documents and reports** are generated to inform stakeholders about the functioning of the project, to formally document the process and to encourage transparency. Some of these tools are operational work plans, activity work programme schedules, resource/budget schedules, checklists, regular progress reports, guides and terms of reference.

Regarding the **technological dimension** of the project, the design, installation and set up of the equipments can follow the next steps (EURO-SOLAR, 2013):

- a) Design of the equipment considering the specific needs of the community (number of users, energy needs, economical sustainability).
- b) Call for tenders, selection of suppliers and settle the contract with the supplier of the equipment.
- c) On-site verification of the location of the installation, analysing the final use of the energy, technical and social factors.
- d) Adequacy of the buildings that will host the auxiliary equipment ensuring the required conditions in terms of space, security and hygiene.
- e) Purchase, transport, installation and launch of the equipment according to the previously established schedule.
- f) Utilisation and maintenance of the equipments with the support of the supplier and the participation of the local representatives.
- g) Monitoring of the equipments (in situ and remote) to supervise the functioning of the installation and to strengthen technical competences in the local areas.

During the project implementation, it is also relevant to promote its **visibility and the interchange of good practices** through meetings, conferences, workshops, websites, social networks... these activities will strengthen its impact and sustainability in the middle-long term.

#### PHASE 4. EVALUATION

OECD (1998) defines evaluation as an assessment, as systematic and objective as possible, of an ongoing or completed project, programme or policy, its design, implementation and results. The aim is to determine the **relevance** and fulfillment of objectives, developmental **efficiency, effectiveness, impact** and **sustainability**. An evaluation should provide information that is credible and useful, enabling the integration of lessons learned in the decision-making process.

From a rural development perspective, the evaluation of renewable energy projects should be **participatory, learning oriented, impartial** and **transparent**. To define the main components of the evaluation it is usual to prepare the **Terms of Reference**, consisting of a document that specifies the contents of the evaluation (title, introduction, background, methodology, work plan, task force, deadlines, budget...).

The selection of **techniques** to be used during the evaluation process is based on the characteristics of the evaluation (scope, time, budget...). As a sample, there can be mentioned focus groups, questionnaires, interviews and documentary analysis. The person or team in charge of the evaluation will systematize the results of their work in the **evaluation report**, which structure should be defined beforehand by taking into account its purpose and target groups.



## 1.6. CONTRIBUTIONS OF RENEWABLE ENERGY TO RURAL DEVELOPMENT

Traditionally, agriculture has been the main economic sector in rural areas. Nevertheless, to avoid depopulation, new activities should play an important role in revitalizing small municipalities. Some of these activities can be the production and use of renewable energies, such as biomass, photovoltaic and wind energy, which may facilitate the synergies between the policies of rural development, climate change and energy. The analysis of the contribution of renewable energies to rural development must take into account different variables at socioeconomic and environmental levels, such as (adapted from Burguillo, 2008):

- a) **Quantitative and qualitative impact on the employment.** Some of the aspects to consider are the total number of employments that have been created, in which phase of the project (construction, functioning and maintenance) they have been created, what qualification is required in the new employments, the profile of the hired people,...
- b) **Demographic impact.** One of the main challenges of rural areas is to stop, and, if possible, to reverse the depopulation process. It is probable that renewable energies will help to fix the population in rural areas. In this sense, the effects of biomass projects will probably be bigger in comparison with other energies.
- c) **Energy impact.** Renewable energy projects use the energy resources from the territory and contribute to energy self-sufficiency, improving the flexibility and security of energy provision.
- d) **Educational impact.** The technological component of renewable energy projects is associated with the capacity building of the local population. In addition, awareness raising and dissemination can accompany these projects and promote the use of these energies among citizens.
- e) **Impacts on the local productive fabric.** If the projects are integrated in the local economy, new productive links can be created with local suppliers and local clients, promoting the productive diversification in the area.
- f) **Social cohesion and human development.** Renewable energies can improve the future perspectives of the rural population, increasing their self-confidence and promoting the creation of associations.
- g) **Income distribution.** Thanks to income generation (employment, rent of land, transference of the company for local projects...) it is desirable that the project helps in the reduction of the differences between the different groups of population.
- h) **Local actors' implication.** The involvement of the local interest groups is essential for the project sustainability, being associated with the perception among the population of the benefits produced by the project.
- i) **Impact on tourism.** The "demonstrative effect" of the projects encourages the visit of professionals and individuals, causing an increment of visitors in the area and generating additional income.
- j) **Impact on the local R+D+i** due to the use of new technologies in the rural areas. In this sense, the "demonstrative effect" of good practices can increase the attention and motivation of other groups with an interest in the project.
- k) **Impact on the municipal budget.** The implementation of a renewable energy project can have important positive effects in terms of the municipal budget through different means such as energy saving and subsidies from European, national or regional sources.
- l) **Endogenous resource use.** The bottom-up approach is the basis for the appropriate utilization of local resources (physical, human, social...) that will facilitate the continuation of the project once the external support has ended.



- m) **Climate change mitigation.** The reduction of greenhouse gas emissions confirms the role of renewable sources in climate change mitigation, as has been recognized in the institutional framework (as mentioned in section 1.2. of this guide).
- n) **Other environmental impacts,** such as those concerning water resources (use of water and contamination due to wastewater), noise, birds, waste generation, biodiversity, land impact... In this sense, it is essential to distinguish between the impacts created during the equipment manufacture, the installation of the equipments and the functioning/maintenance of the installations.

## 2. RENEWABLE ENERGY TECHNOLOGIES

### 2.1. INTRODUCTION TO ENERGY TECHNOLOGY

#### 2.1.1. ENERGY AND POWER

**Energy** can be considered as the ability of matter, either by itself or through transformations, to generate **heat** and/or **work**. It should be noted that **heat** corresponds to the transfer of thermal energy between two bodies that are at a different **temperature**, whereas there is only **work** if the force applied to a mass is capable of producing the movement of the latter (Figure 5).



Figure 5. Force, displacement and work. Source: Adapted from Microsoft (2010)

In the International System, the energy unit is the **Joule (J)**, although in practice multiples of this and other units are also used. Namely:

1 kilojoule (kJ) = 1000 J
1 kilocalorie (kcal) = 4.18 kJ
1 kilowatt-hour (kWh) = 3600 kJ = 860.4 kcal
1 megawatt-hour (MWh) = 1000 kWh = $3.6 \times 10^6$ kJ
1 tonne of oil equivalent (toe) = 11630 kWh = $10^7$ kcal = $4.18 \times 10^7$ kJ

*Please, note that kcal and toe are units used exclusively for thermal applications.*

**Power** is the amount of energy generated, distributed or consumed per unit of time. The **useful power** is the power actually used and the **power absorbed** is the one that comes from the power sources (for example from fuels or from the electricity grid). **Efficiency** is the quotient of both. In the following sections these concepts are thoroughly explained.

In the International System, the power unit is the Joule/second or **Watt (W)**, multiples of it being frequently used, such as the kilowatt (kW) or megawatt (MW).

1 kW = 1000 W = 860.4 kcal/h
1 MW = 1000 kW



The basic principle of the **conservation of energy** indicates that "energy is not created or destroyed but only **transformed**".

### 2.1.2. SOURCES OF ENERGY

When we speak about **primary energy sources** we mean those that have not undergone human transformation, such as oil, solar energy, wind power or hydraulics. In order to obtain **secondary energy sources**, certain procedures are used to convert them into energies of direct application, as is the case of electric energy. Another classification of energy is the following:

- a) Energies from **non-renewable sources**, existing in nature, consumed at a rate that exceeds its possible regeneration (coal, oil, natural gas and uranium for nuclear fission processes).
- b) Energies from **renewable sources**, whose rate of natural generation or possible regeneration is higher than their consumption, and can therefore be considered as practically inexhaustible.

The terminological dispersion in the field of energy means that terms such as **clean energy** and **green energy** are used in the usual language as synonyms for renewable energies, when their meanings do not always coincide. In fact, Directive 2009/28/EC of the European Parliament and of the Council of 23 April 2009 on the promotion of the use of **energy from renewable sources** refers to the latter, indicating that they are *"those that come from non-fossil fuels, that is wind, solar, aerothermal, geothermal, hydrothermal and oceanic, hydropower, biomass, landfill gas, depuration plant gas and biogas"*.

Taking into account the impact on the local development of the different sources of renewable energy and its technology, which must be **accessible and mature** (that is, developed, tested and at a reasonable cost) from now on we will focus on the small and medium-sized facilities most suitable for our purpose, namely:

- Biomass and biogas
- Mini hydraulic
- Small wind
- Thermal solar
- Photovoltaic solar

### 2.1.3. THERMAL ENERGY, HEAT AND TEMPERATURE

**Thermal energy** or **internal energy** is the one stored by matter, which proceeds from the nature, order and movement of the atoms that make it up. The **temperature** indicates the level of the thermal energy of a body or system of particles with respect to another body of reference. It can be measured directly in degrees, by using calibrated thermometers at different scales, the Kelvin scale being adopted in the International System. It uses **absolute values**, while the remaining scales (Celsius and Fahrenheit) employ **relative values**. The first is the most used, except in the Anglo-Saxon world (Figure 6).

**Heat** is the flow of thermal energy that occurs between two bodies (or parts of them) or between a body and its surroundings when there is a temperature difference between them. "Thermal energy" and "heat" are not synonymous. In **thermal processes**, this flow is necessarily transmitted from the hottest body (at higher temperature) to the colder one (at lower temperature). However, it is possible to reverse this sense of circulation by using heat pumps, machines that employ **thermodynamic processes**.



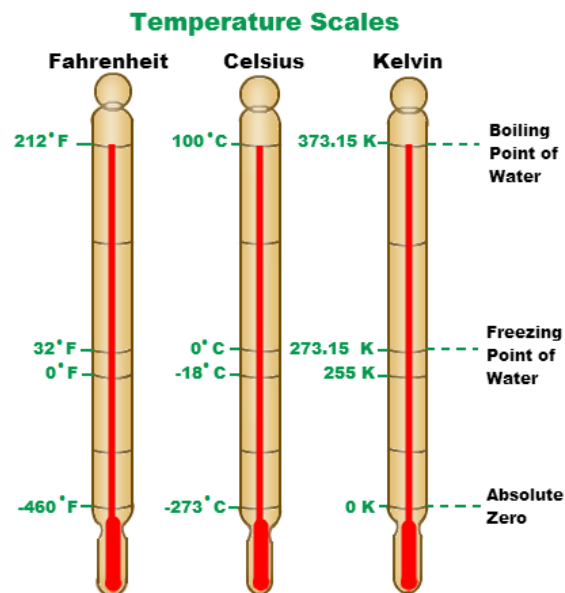

Figure 6. Thermometric scales and reference points. Source: TutorVista (n.d.)

In both cases, the transmission of thermal energy is carried out by **conduction, convection or radiation**, or in a combination of these three modalities. The **conduction** occurs when the body that yields the heat is in direct contact with the one that takes it. The different densities of a fluid in a cold zone and in a hot zone cause **convection currents** that activate the thermal flow. Finally, **radiation** uses electromagnetic waves (basically infra-red rays) without physical support, which cause the heating element of the receiver (Figure 7).

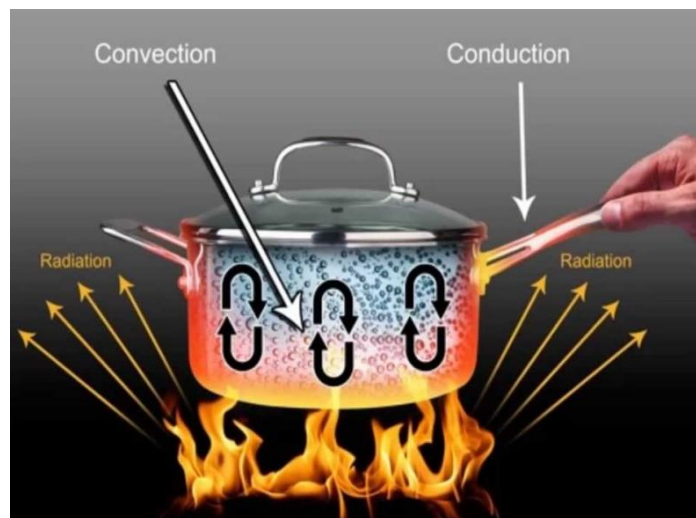

Figure 7. Heat transfer. Source: Futurism (n.d.)

**Combustion** is a rapid physicochemical reaction that releases much of the thermal energy of a fuel by combining it with an **oxidizer** (usually oxygen from the air), resulting in heat, steam, and other combustion products. The process is initiated by an activation energy that achieves a temperature or **point of ignition** and is maintained by a **chain reaction** (Figure 8).

When we speak of **calorific power** we usually refer to the **lower calorific value** in which the possible recovery of the heat of the water vapor produced in the combustion, only possible in technology of a certain complexity (condensing boilers, cogenerators), is not contemplated.

According to the flame **propagation velocity** (visible manifestation of combustion), it is referred to as the **combustion** itself ( $V \leq 1 \text{ m/s}$ ), **deflagration** (values of  $V > 1 \text{ m/s}$  and less than the speed of sound) and **explosion** ( $V \geq \text{the speed of sound}$ ).



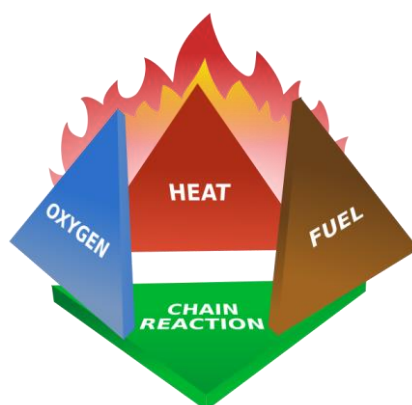

Figure 8. Tetrahedron of fire. Source: Wikimedia (n.d.)

## 2.1.4. MECHANICAL ENERGY

Mechanical energy is the one that can be transformed into work. It is a secondary energy source, since it comes from thermal energy (internal combustion or combustion engines and gas or steam turbines) or from the transformation of **potential energy** ( $U_g$ ) into **kinetic energy** ( $K$ ).

The first is a positional energy  $U_g$ , which has a value related to the slope relative to a reference point, while the second  $K$  depends on the mass and the square of velocity. Mechanical energy is the sum of potential energy and kinetic energy (Figure 9).

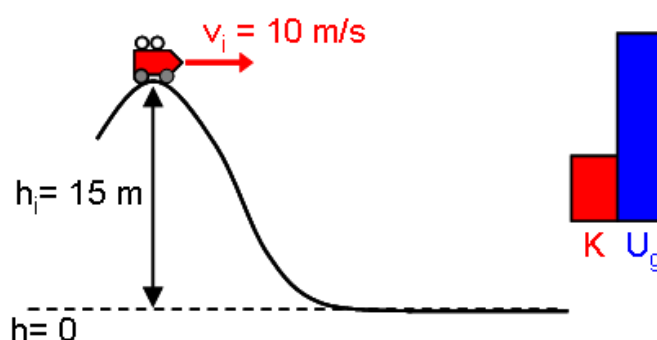

Figure 9. Mechanical energy. Source: Scripts Mit (n.d.)

## 2.1.5. ELECTRIC POWER

### INTRODUCTION

It is considered as a final energy because it comes from other sources. Its versatility allows it to be used for heat (heaters and heat pumps), chemicals (battery charging/discharging) and magnetic (electrical machines) processes.

### BASIC PARAMETERS

The **electric current** (Amperes) is a flow of positive or negative (electrons) charges that circulate through a conductor of a certain **resistance** (Ohms), thanks to the existence of an electrical difference or **potential difference** (Volts). The **direct current** (DC) always circulates in the same direction, while the **alternating current** (AC) inverts it periodically. The number of cycles/second of the AC is called **frequency** (50-60 Hertz).

**Ohm's law** mathematically relates the relationship between the potential difference, the electric current and the resistance of a conductor, as represented in Figure 10. It is the fundamental law on which the calculations of electrical technology are based and it establishes that the intensity of the



electric current (I) that circulates through an electric conductor is directly proportional to the difference of the potential applied (V) and inversely proportional to the resistance of the same (R):

$$I = V/R$$

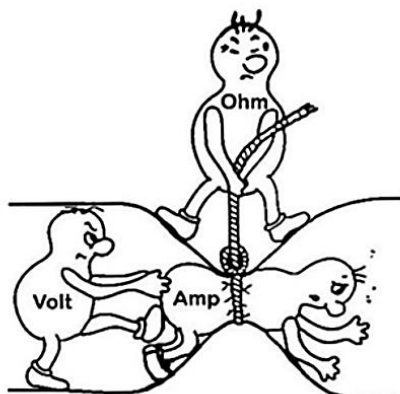

Figure 10. Ohm's Law. Source: Programa Casa Segura (2005)

The **electric power** is directly proportional to the current intensity and the potential difference. Table 2 shows the interrelation between these magnitudes for normalized direct current voltages

Table 2. Relation between power, voltage and current in direct current. Source: Own Elaboration

POWER	STANDARD CURRENT VOLTAGES ON CONTINUOUS CURRENT					
	6 V	12 V	18 V	24 V	36 V	48 V
100 W	16,7 A	8,3 A	5,6 A	4,2 A	2,8 A	2,1 A
150 W	25,0 A	12,5 A	8,3 A	6,3 A	4,2 A	3,1 A
200 W	33,3 A	16,7 A	11,1 A	8,3 A	5,6 A	4,2 A
250 W	41,7 A	20,8 A	13,9 A	10,4 A	6,9 A	5,2 A
300 W	50,0 A	25,0 A	16,7 A	12,5 A	8,3 A	6,3 A
350 W	58,3 A	29,2 A	19,4 A	14,6 A	9,7 A	7,3 A
400 W	66,7 A	33,3 A	22,2 A	16,7 A	11,1 A	8,3 A
450 W	75,0 A	37,5 A	25,0 A	18,8 A	12,5 A	9,4 A
500 W	83,3 A	41,7 A	27,8 A	20,8 A	13,9 A	10,4 A
550 W	91,7 A	45,8 A	30,6 A	22,9 A	15,3 A	11,5 A
600 W	100,0 A	50,0 A	33,3 A	25,0 A	16,7 A	12,5 A
650 W	108,3 A	54,2 A	36,1 A	27,1 A	18,1 A	13,5 A
700 W	116,7 A	58,3 A	38,9 A	29,2 A	19,4 A	14,6 A
750 W	125,0 A	62,5 A	41,7 A	31,3 A	20,8 A	15,6 A
800 W	133,3 A	66,7 A	44,4 A	33,3 A	22,2 A	16,7 A
850 W	141,7 A	70,8 A	47,2 A	35,4 A	23,6 A	17,7 A
900 W	150,0 A	75,0 A	50,0 A	37,5 A	25,0 A	18,8 A
950 W	158,3 A	79,2 A	52,8 A	39,6 A	26,4 A	19,8 A
1000 W	166,7 A	83,3 A	55,6 A	41,7 A	27,8 A	20,8 A

Most of the receivers use **three-phase alternating current** at 380 V (phases L1, L2 and L3) or **single-phase alternating current** at 230 V (L1-N, L2-N, L3-N). As shown in Figure 11, both options can be available in **4-wire distribution networks** (three-phase and neutral), PE being the protective conductor or **earthing**.

The calculation of electric power in alternating current is more complex than in direct current because of the introduction of other parameters such as **frequency** and **power factor**.



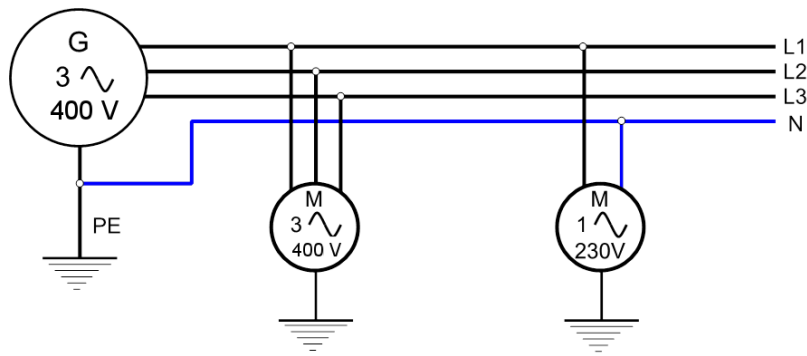

Figure 11. Four-wire distribution. Source: Own elaboration

## ELECTRIC MACHINES

**Electric machines** produce or convert electric energy into heat and/or work or modify their parameters (voltage, intensity, type of current ...), being classified into five large groups:

- a) Generators, which produce electricity: Alternators (Figure 12), chemical generators, photovoltaic panels...

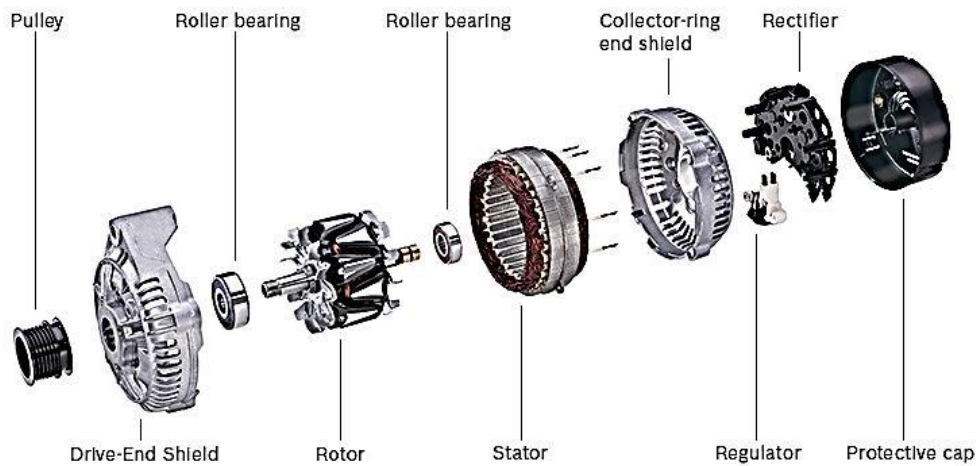

Figure 12. Alternator. Source: Br. Bosch-Automotive (n.d.)

- b) Transformers, which modify the parameters of the alternating current: Voltage, intensity and power (Figure 13)



Figure 13. Three-phase autotransformer 400/230 V. Source: Asfer Transformers (n.d.)





- c) Converters (Figure 14), which change the type of electric current, switching from alternating current to direct current (rectifiers), from direct current to alternating current (inverters) and modifying the frequency of alternating current (frequency inverters)



Figure 14. Single-phase rectifier. Source: Fagor (n.d.)

- d) Accumulators (Figure 15), which, through a chemical process, store direct current by returning it to the grid when it is needed. Its capacity is expressed in Ampere-hours (Ah), equivalent to the load (or discharge) current at the rated voltage for a time. For example, a battery of 100 Ah / 24 V is able to supply, if fully charged, a current of 20 A for 5 hours with a 24 V operating voltage.



Figure 15. Accumulator battery. Source: Tudor (n.d.)

Table 3 specifies the interconnected energy stored in a fully charged battery in relation to its rated capacity and voltage.

Table 3. Energy stored in a battery with a charge of 100%. Source: Own elaboration

CAPACITY	NOMINAL TENSION		
	6 V	12 V	24 V
20 Ah	120 Wh	240 Wh	480 Wh
40 Ah	240 Wh	480 Wh	960 Wh
60 Ah	360 Wh	720 Wh	1440 Wh
80 Ah	480 Wh	960 Wh	1920 Wh
100 Ah	600 Wh	1200 Wh	2400 Wh
120 Ah	720 Wh	1440 Wh	2880 Wh
140 Ah	840 Wh	1680 Wh	3360 Wh
160 Ah	960 Wh	1920 Wh	3840 Wh
180 Ah	1080 Wh	2160 Wh	4320 Wh
200 Ah	1200 Wh	2400 Wh	4800 Wh
220 Ah	1320 Wh	2640 Wh	5280 Wh
240 Ah	1440 Wh	2880 Wh	5760 Wh
260 Ah	1560 Wh	3120 Wh	6240 Wh
300 Ah	1800 Wh	3600 Wh	7200 Wh
350 Ah	2100 Wh	4200 Wh	8400 Wh
400 Ah	2400 Wh	4800 Wh	9600 Wh



- e) Receivers or appliances that consume electrical energy: motors, heat dissipation resistors (Figure 16), electronic equipment, lighting ...



Figure 16. Submersible heating resistors. Source: Electricfor (n.d.)

Thanks to the current development of technology in the areas of power electronics and information technology, **smart grids** allow the participation of users to distribution networks, being at the same time producers and consumers of renewable energy, turning over to the network the excess of produced energy and collecting from it the energy that exceeds its production capacity.

### 2.1.6. COUPLING OF GENERATORS AND ELECTRICAL ACCUMULATORS

The generators and/or accumulators can be connected in the following ways:

- a) Serial connection, adding their tensions and sharing a common intensity (see Figure 17)

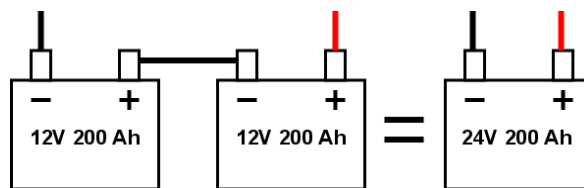

Figure 17. Coupling of accumulators in serial connection. Source: Own elaboration

- b) Parallel connection. With the same voltage and a given current corresponding to the sum of the intensities of all the branches (Figure 18)

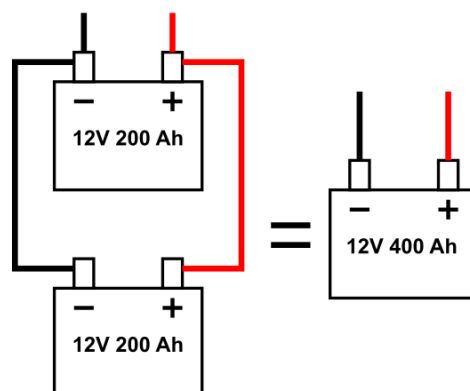

Figure 18. Coupling of accumulators in parallel connection. Source: Own elaboration

- c) Serial-parallel connection, fulfilling both conditions (Figure 19)



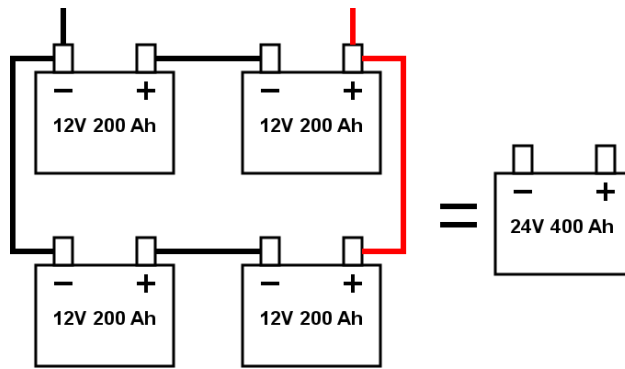

Figure 19. Coupling of accumulators in serial-parallel. Source: Own elaboration

### 2.1.7. ENERGY, POWER, EFFICIENCY AND CONSUMPTION

In order to clarify the interrelation between these already defined concepts, the next paragraphs describe some samples of application of electric thermal energy.

- a) An electric motor powered by a distribution network is shown in Figure 20. The mechanical power on shaft (1) and the efficiency (2) are the starting data and are listed on the nameplate of the machine. The electrical power (3) is controlled by a wattmeter and the consumption absorbed from the network during the time of use (4) by an energy meter (5).

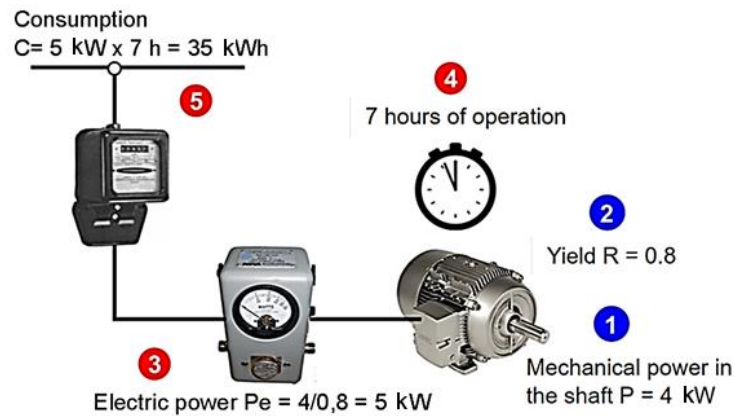

Figure 20. Parameters of an electric motor. Source: Own elaboration

- b) A heating boiler (1) with a gas oil burner (3) is detailed in Figure 21. The useful power of the boiler is the starting point, estimating losses of 10% by transmission of the heat transfer fluid and burnt gases (2). The power of the burner (3) and the calorific value of the diesel (4) determine the consumption in litres for a given time (6).

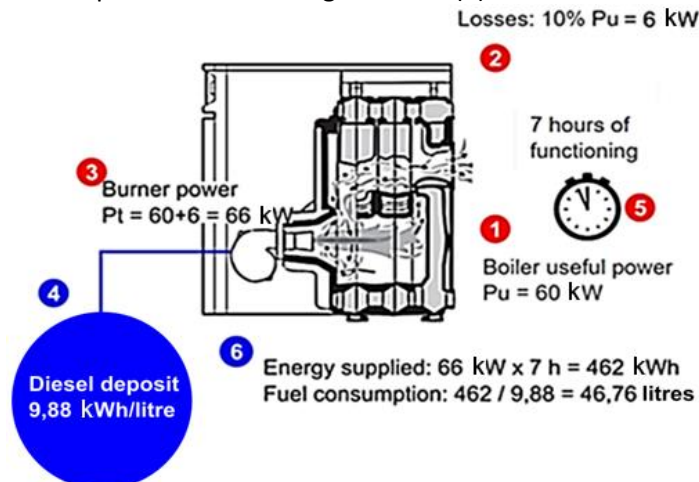

Figure 21. Parameters of a thermal generator. Source: Own elaboration



- c) Figure 22 shows the operation and parameters of air-water heat pump for home heating. By means of a thermodynamic process the external unit draws heat from the exterior (3) by injecting it into the interior (1). Its coefficient of energy efficiency (2) (Coefficient Of Performance - COP = 3) implies that the generated thermal power is three times the electricity consumed.

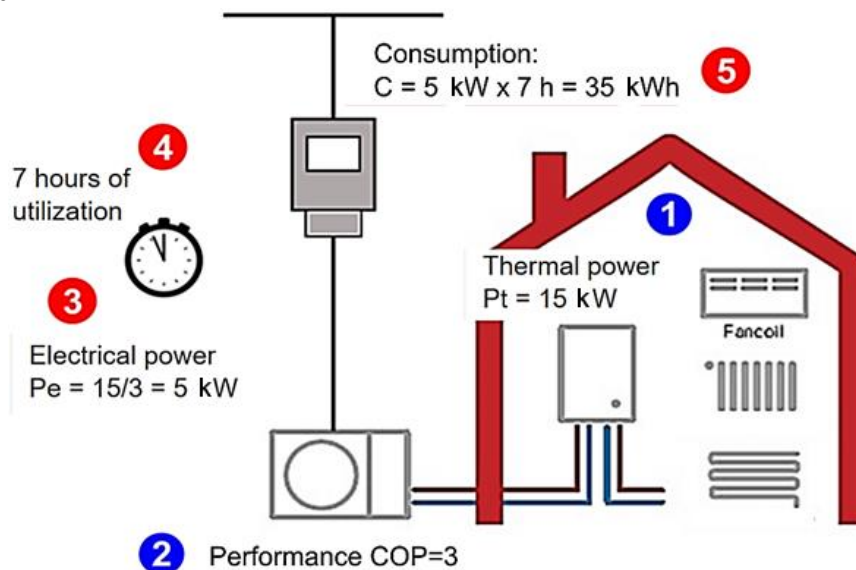

Figure 22. Parameters of a heat pump. Source: Own elaboration

## 2.2. RENEWABLE ENERGIES FROM A LOCAL PERSPECTIVE

### 2.2.1. BIOMASS AND BIOGAS

#### BASIC CONCEPTS

Biomass encompasses a wide range of non-fossil organic matter that, after more or less complex transformation processes, produces thermal energy and electricity. The origin of these materials is very varied, although due to their special impact on the scope of this work we will focus on the following:

- Waste of forestry, agricultural crops and pruning of gardens.
- Waste from agroforestry industries
- Waste of animal origin.

The first two groups allow the elaboration of "improved biomass", in which, by means of simple transformations, products in the form of chips, pellets and briquettes are manufactured, preferably in the place or near their extraction. This location can reduce transport and distribution costs (by reducing their volume) and homogenize the size and calorific value of biofuels, allowing the automation of the thermal installations that use them (in particular pellets, Figure 23)



Figure 23. Pellets. Source: Profesional Pellets (n.d.)



Waste of agroforestry industries (sawdust, tree barks, nutshells, olive bones...) have a high calorific value and are used as biofuels, being subject to the seasonal production volume of the industrial activities that generate them. As with those included in the previous group, their processing and storage is simple and can be used in automatic installations. In Figure 24 we can see an automatic loading boiler (1) suitable for burning pellets, almond shells and olive bones, with electronic control and automatic soot cleaning. A hot water accumulator can be located in the tank (2) and an ash compressor can be coupled to the ashtray (3) to reduce its volume.



Figure 24. Automatic polyifuel boiler. Source: Domusa (n.d.)

The improvement in the costs and distribution networks of pellets has revitalized in the comfort market the stoves and "economic" stoves that use this biofuel. The most sophisticated models can act both as kitchens and heating boilers.

## HEATING INSTALLATIONS WITH SOLID BIOMASS

### Determination of thermal power

The thermal power corresponds to the one necessary to compensate the losses by different concepts such as the transmission and renovation of air (natural or forced), or orientation. The operating regime (hours/day, high or low thermal inertia, etc.) and other concepts such as losses in heat distribution must also be taken into account, which implies that the calculation can be complex. The main component, the transmission losses, is calculated through the formula  $P = K \times S \times TD$  where:

- $P$  = Transmission losses in Watts
- $K$  = Transmission coefficient in  $W/m^2 \times K$ , also known as transmittance, for which the letter  $U$  is used.
- $S$  = Surface in  $m^2$
- $TG$  = Temperature Gradient

The manufacturers of insulation panels frequently indicate in their technical data the values of the thermal resistance  $R$ , a value inverse to the transmittance.

Although there are numerous tables with values of  $K$ , for preliminary effects there can be used Table 4, in which values of the thermal power density in  $W/m^2$  in classic construction houses in the rural areas are given, according to their orientation and thermal insulation. For its elaboration, values extracted from Spanish technical standard NBE-CT-79 have been used, using the following parameters:

- $IK$  = Renewals/day by infiltration
- $TD$  = Temperature difference between indoor and outdoor (20-24-28°C)
- Proportion between length and width:  $L/W = 1,5$
- Glazing ratio with respect to the surface of vertical walls: 18%
- Heat loss in boiler and distribution (10%)
- Inner height: 3,00 m



- Intermittent increase: 33%

Table 4. Thermal power density in W/m<sup>2</sup> required in rural housing.  
Source: Own elaboration based on the standard NBE-CT-79

INSULATION TYPE	IK	TD	W/m <sup>2</sup> according to orientation				
			S	W	E	N	Average
With thermal panel 50 mm and double glazing	1	20K	39	55	59	63	54
		24K	47	66	71	76	65
		28K	55	78	83	89	76
Air chamber and single glazing	1,5	20K	65	70	74	79	72
		24K	86	92	99	105	96
		28K	101	108	116	123	113

In the total calculation of losses in agricultural farms, the concept of "renewals by infiltration" is replaced by the "required volume of air" per animal and hour, which appears in different tables, such as those derived from the standard DIN 1946. Concrete enclosures on whose inner side polyurethane is projected present a better cost/isolation relation. The old biomass boilers of natural convection or forced air are being replaced by low temperature radiant floor systems with water at 40/45 °C (see Figure 25) which allows the biomass to combine with the use of thermal solar panels.



Figure 25. Underfloor heating. Source: Tecnoambient (n.d.)

### Basic scheme

Figure 26 shows the components of a typical heating and Sanitary Hot Water (SHW) installation using a biomass boiler, which could correspond to a farm with attached housing.

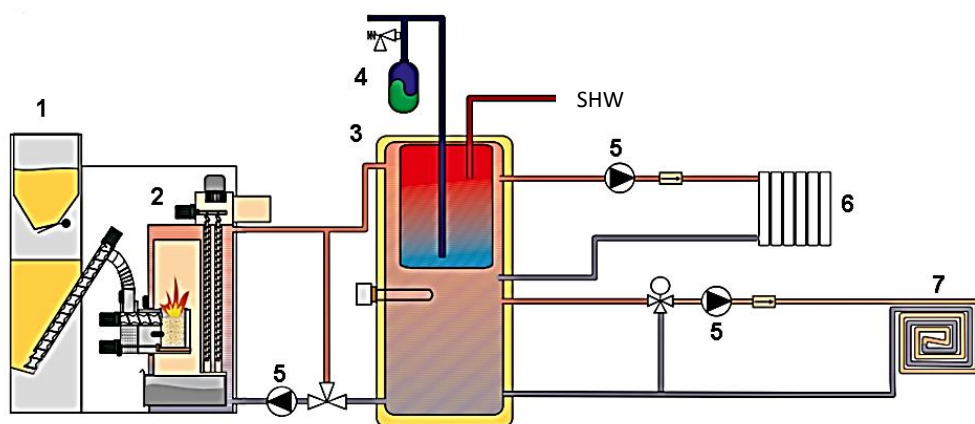

Figure 26. Basic heating and SHW installation with biomass. Source: Domusa (n.d.)



1. Biomass storage
2. Electronic control boiler and automatic cleaning of soot
3. Thermal storage tank
4. Expansion tank
5. Boiler circulator
6. Comfort system radiators
7. Low temperature radiant floor

## BIODIGESTERS

Residues of animal origin allow their transformation into biogas through their anaerobic fermentation, that is, in the absence of oxygen, taking advantage of the bacteria that are already in the manure. In this process, carried out in biodigesters (see Figure 27), organic matter is converted into biogas and gives a high quality natural fertilizer as a residue. Biogas is a mixture of gases in which methane gas predominates (between 60% and 80%) and has a very acceptable calorific value valid for kitchens and heating installations, in housing farms and greenhouses. In addition, in installations of a certain size, it is possible to feed internal energy motors for the generation of electricity.

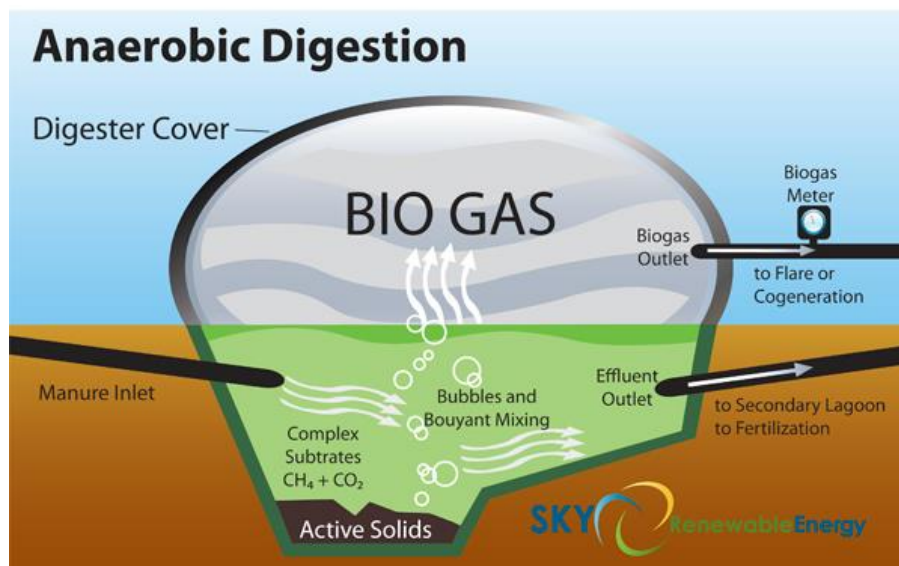

Figure 27. Biodigester. Source: SKY Renewable Energy (n.d.)

To purify the toxic and very corrosive sulfhydic acid, the use of filters is required. For sanitary and efficiency reasons, the faecal waters should not be poured into the biodigester but be treated separately. The "clean" water cannot be poured either because the detergents can kill the bacteria and slow down or stop the process.

## DESIGN OF BIODIGESTERS

### Guidelines for the design

The biogas has a calorific value of 4500 to 5600 kcal/m<sup>3</sup>. In addition to methane, a certain amount of hydrophilic, toxic and highly corrosive hydrogen sulfide is found in the biofuel, which means that suitable filters must be installed and need to be replaced at the frequency indicated by the manufacturers.

The design of a biodigester should take into account two essential parameters, whose combination will mark the volume of the biodigester:



- a) The average temperature of the location. The higher the temperature, the higher the activity of the fermentation bacteria, and therefore the less time required to produce the biogas (Table 5). It can be considered that at temperatures below 5 °C biodigesters are inoperative.

Table 5. Retention time according to temperature. Source: Martí (2008)

Temperature	Holding time
30 °C	15 days
20 °C	25 days
10 °C	60 days

- b) The manure load per day, which determines the daily production of biogas. Table 6 shows the production of daily fresh manure for different animals per 100 kg weight.

Table 6. Daily fresh manure production. Source: Martí (2008)

Cattle	kg of fresh manure produced per 100 kg of animal weight
Pork	4
Bovine	7
Goat	4
Rabbits	3
Equine	7

We must consider that if the animals are grazing it will be difficult to collect more than 25% of the manure produced, while if they are closed on farms 100% of the manure can be used. The average biogas production values are given in Table 7.

Table 7. Biogas production. Source: Martí (2008)

Cattle	Litres of biogas produced per day per kg of fresh manure loaded daily
Pork	51
Bovine	35,3

The total volume of the biodigester will be the sum of the part destined for liquid and that which is needed to house the gas. The volume occupied by the liquid will correspond to the product of the daily load (manure and water) and the days of retention, while the gaseous volume will be the third part of this.

### Energy supplied

The amount of the thermal energy to be supplied by the biogas will be given by the product of its calorific value and the daily production. For feasibility analysis Table 8 can be used, which compares energy equivalents with different fuels.

Table 8. Energy equivalents of biogas. Source: Martí (2008)

1 m <sup>3</sup> of biogas is equivalent to:	
Wood	1,3 kg
Dry loaf	1,2 kg
Alcohol	1,1 litres
Gasoline	0,8 litres
Gas-oil	0,65 litres
Natural gas	0,76 m <sup>3</sup>





Carbon	1,5 kg
Electricity	2,2 kWh

## 2.2.2. MINI HYDRAULIC

### BASIC CONCEPTS

The foundation of hydroelectric technology is the transformation of the existing potential energy in the slope of a watercourse, converted into kinetic energy, into electric energy by passing water through turbines of different types. Hydroelectric technology is a "mature" technology that has reached a high level.

There is no general consensus in different countries on the classification of plants in relation to their power. The evolution of the technique makes possible the use of hydroelectric energy for applications of reduced power, in which self consumption within the rural areas plays an important role. In the most usual terminology, the term "mini power plants" is usually used for those with a power of more than 100 kW and less than 10 MW and "micro power plants" for those of lower power. In all categories and according to the collection and return systems of turbinated water, two types of power plants are considered: dam power plants (Figure 28) and running water power plants (Figure 29).

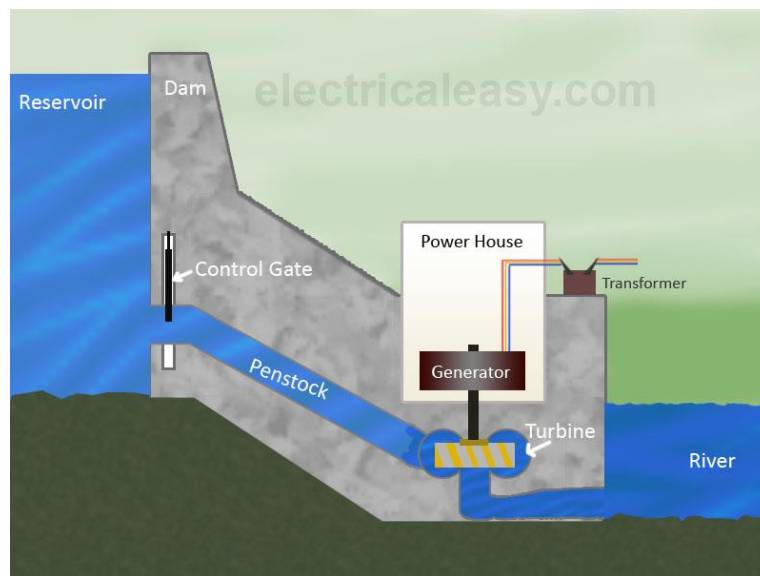

Figure 28. Dam power plant. Source: Electricaleasy (n.d.)

In the dam power plants the water of the reservoir is contained by the dam. The forced pipe engages the turbine located in the central unit which is connected to the electric net. The channel reverses the water to the river bed.



Figure 29. Flowing water plant. Source: IDAE (2006)



As shown in Figure 29, in the running water power plants, part of the running water is diverted by a bifurcation caused by a small dam (1) and is transported through the bypass channel (2) to the loading chamber (3) where the water flow is stabilized. The forced pipe (4) leads the water to the central building (5) where the turbine-generator and the electrical regulation and control unit are located. Finally, the discharge channel (6) returns the turbinated water to the river bed. The supply of electrical energy is always done at low voltage, depending on the energy supplied from the available flow. This is the reason why this type of plants is also known as "unregulated flow".

**POWER AND ENERGY TO BE SUPPLIED BY A CENTRAL**

The instantaneous power of an electrical plant is conditioned by the height of the jump, the amount of water passing through the turbine and its performance (Figure 30).

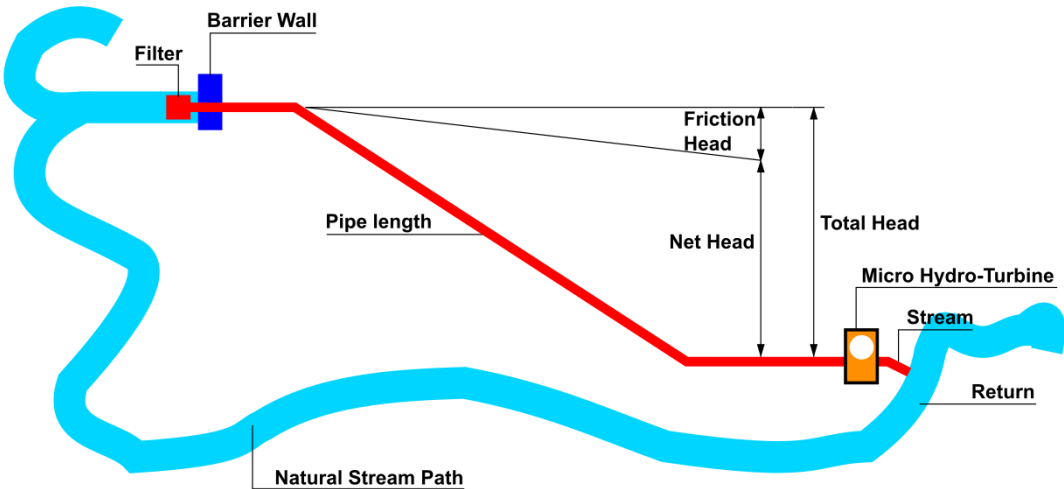

Figure 30. Micro hydro-turbine Installation. Source: Own elaboration

This is:

$$P = 0.9 \times 9.81 \times Q \times H_N \times \rho \times \sigma$$

An expression in which

- P = Power in W
- Q = Flow of equipment, expressed in l/s, which is the one transferred by the turbine. The flow distribution curve (Figure 30) allows us to know the average power of the plant in the different months of the year
- H<sub>N</sub> = Net head in meters (total head – friction head).
- ρ = Turbine efficiency (between 50% and 70% for micro turbines)
- σ = Alternator efficiency (about 85%)

Table 9 gives the values that the microturbine output powers can have, in accordance with the existing flow and slope.

Table 9. Output power of a microturbine according to flow and height of the water jump. Source: Own elaboration

FLOW	HEIGHT OF THE WATER JUMP								
	2 m	5 m	8 m	11 m	14 m	17 m	20 m	25 m	30 m
5 l/s	45 W	112 W	180 W	248 W	315 W	383 W	450 W	563 W	675 W
10 l/s	90 W	225 W	360 W	495 W	630 W	765 W	901 W	1126 W	1351 W
15 l/s	135 W	337 W	540 W	743 W	946 W	1148 W	1351 W	1689 W	2026 W



20 l/s	180 W	450 W	720 W	991 W	1261 W	1531 W	1801 W	2251 W	2702 W
25 l/s	225 W	562 W	900 W	1238 W	1576 W	1914 W	2251 W	2814 W	3377 W
30 l/s	270 W	675 W	1081 W	1486 W	1891 W	2296 W	2702 W	3377 W	4053 W
35 l/s	315 W	788 W	1261 W	1734 W	2206 W	2679 W	3152 W	3940 W	4728 W
40 l/s	360 W	900 W	1441 W	1981 W	2522 W	3062 W	3602 W	4503 W	5403 W
45 l/s	405 W	1013 W	1621 W	2229 W	2837 W	3445 W	4053 W	5066 W	6079 W
50 l/s	450 W	1126 W	1801 W	2477 W	3152 W	3827 W	4503 W	5628 W	6754 W
55 l/s	495 W	1238 W	1981 W	2724 W	3467 W	4210 W	4953 W	6191 W	7430 W
60 l/s	540 W	1351 W	2161 W	2972 W	3782 W	4593 W	5403 W	6754 W	8105 W
65 l/s	585 W	1463 W	2341 W	3219 W	4098 W	4976 W	5854 W	7317 W	8780 W
70 l/s	630 W	1576 W	2522 W	3467 W	4413 W	5358 W	6304 W	7880 W	9456 W
75 l/s	675 W	1689 W	2702 W	3715 W	4728 W	5741 W	6754 W	8443 W	10131 W
80 l/s	720 W	1801 W	2882 W	3962 W	5043 W	6124 W	7204 W	9006 W	10807 W
85 l/s	765 W	1914 W	3062 W	4210 W	5358 W	6507 W	7655 W	9568 W	11482 W
90 l/s	811 W	2026 W	3242 W	4458 W	5674 W	6889 W	8105 W	10131 W	12158 W
95 l/s	856 W	2139 W	3422 W	4705 W	5989 W	7272 W	8555 W	10694 W	12833 W
100 l/s	901 W	2251 W	3602 W	4953 W	6304 W	7655 W	9006 W	11257 W	13508 W

The operating hours of the power plant will depend on the available flow rate at each time of the year (Figure 31) and, therefore, on the useful power of the system, as well as its regulation systems (manual and/or automatic) and demand.

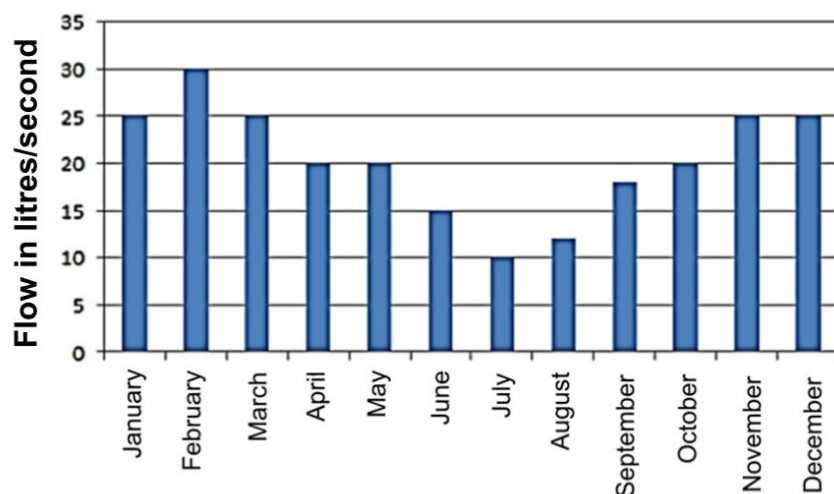

Figure 31. Distribution of flows. Source: Own elaboration

In the installations connected to the grid, all the energy (destined for sale) can be turned over. In isolated installations the excess production is used for the charging of accumulator batteries and, after this process, the remaining energy can be transformed into heat in the dissipating resistors, heat that passes into the air or serves to produce hot sanitary water.

## TURBINES

The essential part of the hydroelectric plants are the turbines and the alternators coupled to them. The most commonly used types are:

- Pelton turbines, used for small flows and large jumps, up to a few hundred meters.



- Turgo turbines, similar to the Pelton ones, suitable for jumps from 30 to 300 m. They are recommended for important variations in flow and turbid waters.
- Francis turbines, built according to the criteria used for large turbines, are the most suitable for medium jump and flow values.
- Kaplan turbines, frequent in small jumps and important flows.

Figure 32 shows a Pelton turbine prepared for its direct adaptation to an alternator.



Figure 32. Pelton turbine. Source: Turbines Info (n.d.)

### 2.2.3. SMALL WIND

#### GENERATORS

The utilization of the kinetic energy of the wind through small wind turbines that convert it, first in mechanical energy and, latter in electrical energy, are the foundation of the small wind technology. The rated powers of these equipment cover a wide range between a few hundred watts and a maximum of 100 kW. Of special interest for our objectives are those of nominal power lower than 10 kW given its applicability in isolated installations.

The wind turbines have different constructive forms, although according to the situation of the axis of the rotor with respect to the ground they are classified in two groups: horizontal wind turbines and vertical wind turbines. The first one requires an automatic guidance system that is not necessary for the second one, since their rotor rotate regardless of the direction of the wind.



Figure 33. Horizontal wind turbine with rotor to windward. Source: Enair (n.d.)



Figure 33 corresponds to a horizontal wind turbine, the most usual in rural areas. Depending on their size and installation height, tubular masts or posts are used to achieve adequate height. Technical specifications provided by manufacturers include values related to wind speed, such as operating range, minimum speed for starting, speed used for determination of rated power and maximum permissible speed.

Other parameters are related to constructive characteristics, such as rotor diameter and/or swept area, as well as nominal power, usually measured at the output of the alternator. The values of the power supplied refer to the sea level, so if the equipment is installed at a higher height, it is necessary to consider the decrease of the air density according to the graph corresponding to Figure 34. Therefore the mechanical and electrical power will decrease in the same proportion. As we see in the example, a wind turbine installed at 1800 meters above sea level reduces its power to 84% of its nominal value.

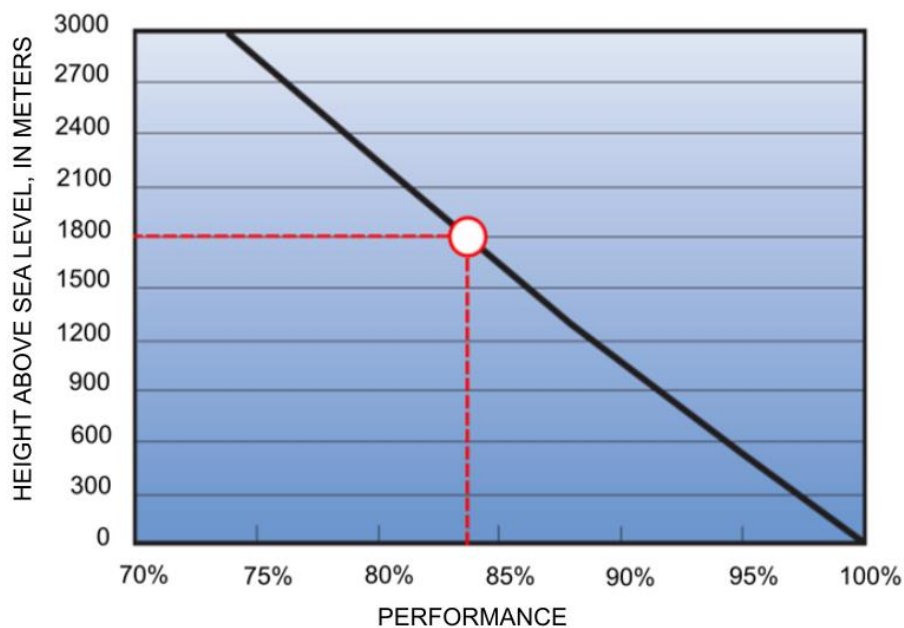

Figure 34. Variation of the efficiency of a wind turbine with the height.  
Source: US Department of Energy (2001)

## ELECTRIC POWER SUPPLIED

The determination of the electrical energy that a generator can produce in a given period is complex, due to the numerous factors to be considered, especially those related to wind speed variability and its distribution. All of these require a rigorous technical study, although we can make an approximation following the next steps:

- a) Establish the location and height of the mast of the wind turbine
- b) Determine the annual wind speed average
- c) Calculate the power density at the location of the wind turbine
- d) Establish the values of the average useful power and the annual electric power that can be supplied by the equipment
- e) Carry out the installation diagram

### a) Location and height

In general, the ideal location of the wind turbine is on the facade on which the dominant wind falls, avoiding the "shadow" of the obstacles in front, which can cause turbulences (see Figure 35). According



to the profile of the terrain, the reduction of power and the energy delivered by the equipment can be considerable, arriving up to 20% with respect to the one that would have in a flat and without obstacles zone.

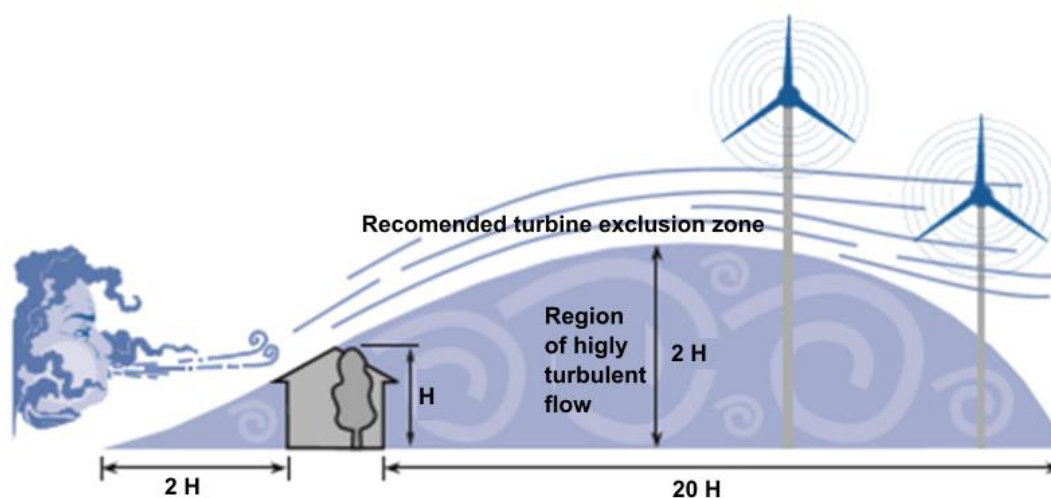

Figure 35. Zone of turbulence caused by an obstacle. Source: US Department of Energy (2001)

As a general rule, the axis of the wind turbine must be at least 10 meters above any obstacle within a radius of 100 meters.

### b) Annual wind speed average

The speed of the wind at any given time can be obtained even by the simple application of the Beaufort scale, based on the direct observation of its effects, but the determination of the annual velocity average of the wind  $V_M$ , which is the one used in all calculations, is much more complex. Different sources have developed wind maps showing the annual wind speed average and power density average at different heights. Many wind maps and local weather stations have annual speed average data taken at 10 meters height. For higher elevations we can use the following table:.

Table 10. Wind speed with respect to the one determined at 10 meters height. Source: Own elaboration

Hub height in meters	10	15	20	25	30	35
Wind speed	100%	106%	110%	114%	117%	120%

Online programs such as ECON (Enair, 2016), based on NASA data, are publicly accessible and easy to use and take into account factors (ie. roughness or terrain profile) that can reduce wind speed. Direct measurement over a period of at least one year is the most advisable method and cup anemometers equipped with data acquisition devices are used (Figure 36).



Figure 36. Anemometer with data acquisition. Source: GIS Iberica (2017)



These equipment are installed in a mast with the location and height predicted for the wind turbine and allow, through the software provided by the supplier, to know the frequency distribution of the wind speeds and therefore determine the average annual speed.

### c) Power density

The wind potential is known as power density or specific power and corresponds to the kinetic energy of the wind which, in a unit of time, goes through an ideal conduit (without friction losses) with a cross-section of one square meter (Figure 37).

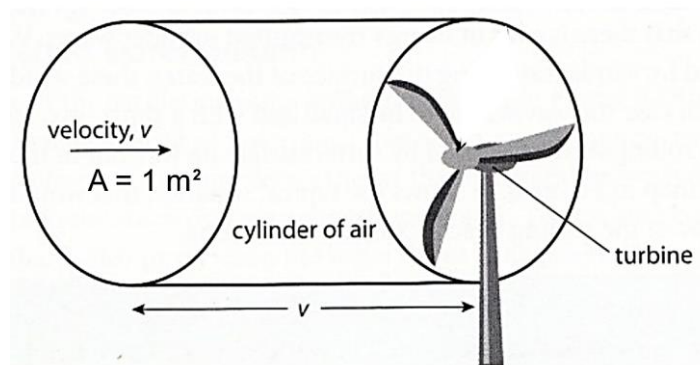

Figure 37. Power density ( $A = 1 \text{ m}^2$ ). Source: Perso Numericable (n.d.)

Its instantaneous value is determined by the formula:

$$D_p = \frac{1}{2} \sigma V^3$$

- $D_p$  = Instant density of power or specific power in  $\text{W/m}^2$
- $\sigma$  = Air density in  $\text{kg/m}^3$
- $V$  = instant wind speed, in  $\text{m/s}$

In a preliminary phase we can assume that the frequencies of the instantaneous values of the wind speed fulfill the so-called "Rayleigh distribution". In this case, the average annual density of specific power  $D_{PM}$  as a function of the wind speed average  $V_M$  is given by the formula:

$$D_{PM} = \frac{1}{2} \sigma (V_M)^3 \times 1.91$$

### d) Medium power and electrical energy to be supplied

The average useful power at the output of the alternator is given by the following formula:

$$P_M = D_{PM} \times A \times \rho$$

$D_{PM}$  = Annual power density average in  $\text{W/m}^2$

$A$  = Sweep area, in  $\text{m}^2$

$\rho$  = Efficiency (between 15% and 30% for minigenerators)

### e) Installation diagram

Figure 38 shows a sample of installation diagram with a three-phase wind turbine with external switch, a charge regulator for batteries (with heat dissipating resistor to compensate the excess of production), accumulator batteries, inverter and auxiliary generator set.



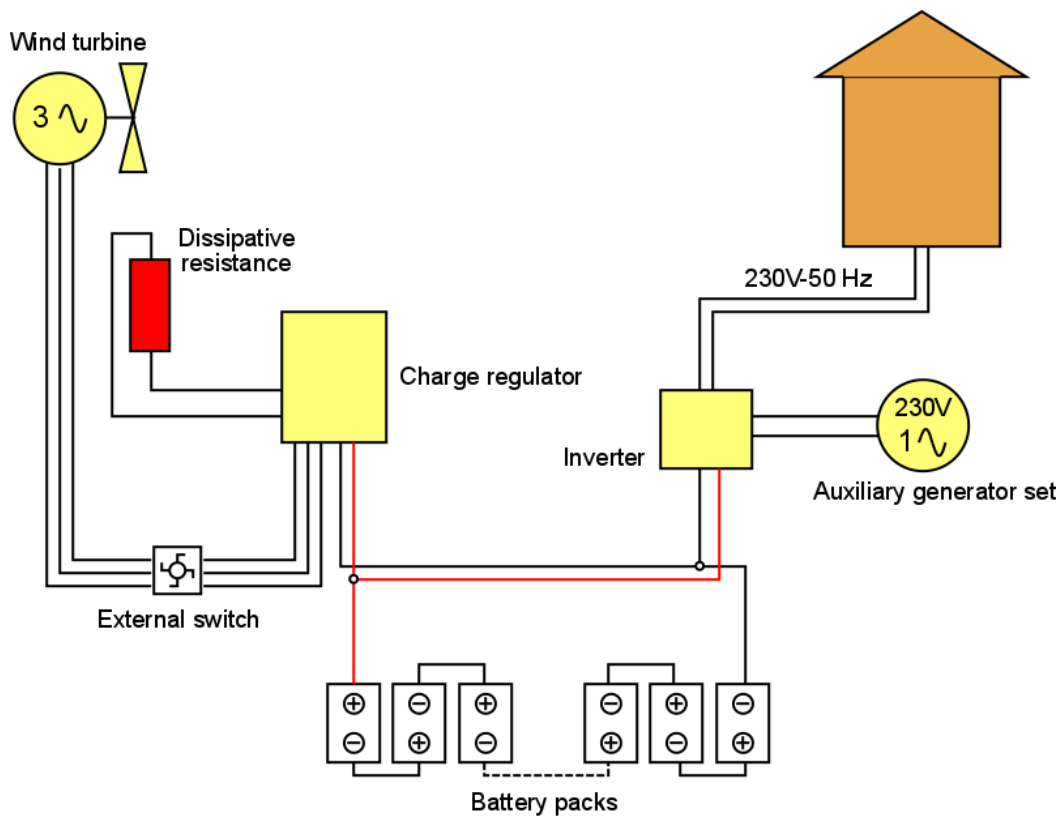

Figure 38. Small wind installation diagram. Source: Own elaboration based on Enair (n.d.)

## 2.2.4. THERMAL SOLAR ENERGY

### SOLAR RADIATION

Most of the renewable energies come directly or indirectly from the solar radiation, electromagnetic waves that do not require a material support for its propagation. The solar spectrum groups different wavelengths, dividing the radiation between the ultraviolet, the visible and the infrared spectrums and other wavelengths. In Figure 39 are indicated their values in nanometers ( $1\text{nm} = 10^{-9}\text{ m}$ )

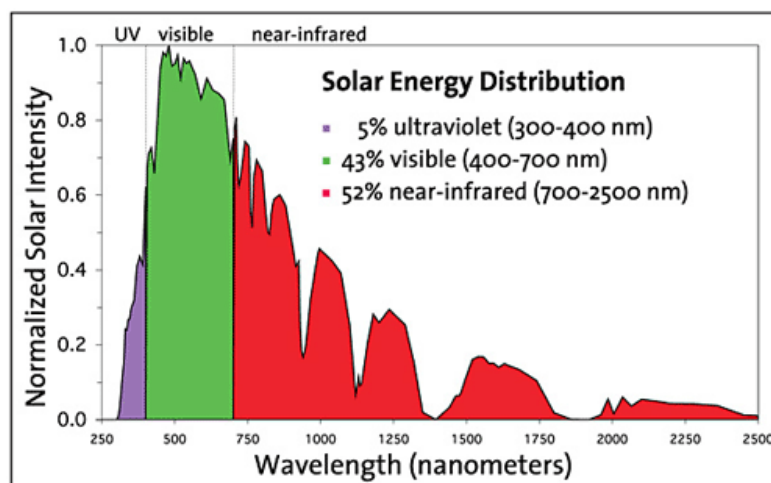

Figure 39. Solar spectrum. Source: In Tech Open (n.d.)

The solar radiation that affects our planet is distributed in direct, diffuse and reflected radiation, varying its proportion according to the climatology (Figure 40).





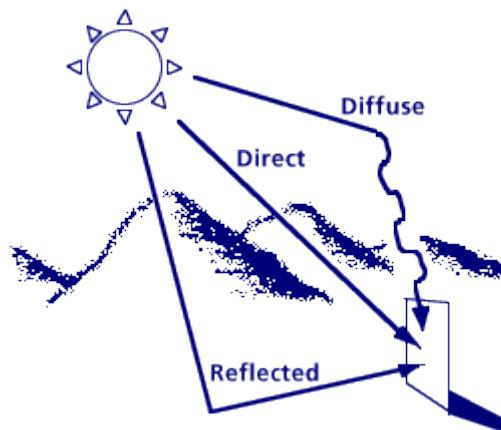

Figure 40. Distribution of solar radiation. Source: Solar Wiki (n.d.)

Basic concepts in the use of solar energy are:

- Solar radiation: energy from the sun in the form of electromagnetic waves.
- Irradiance: incident energy on a surface per unit time and unit area, expressed in  $\text{kW}/\text{m}^2$ .
- Irradiation: incident energy on a surface per unit area and over a certain period of time (day or year). It can be expressed in  $\text{kWh}/\text{m}^2$  or in  $\text{MJ}/\text{m}^2$ . The most used form is  $\text{kWh}/\text{m}^2 \times \text{day}$ .

The values indicated in the solar maps usually refer to the horizontal plane.

Solarimeters, as the one in Figure 41, measure global irradiance, that is, the sum of direct and diffuse radiation, but not the reflected one (with little importance in the technology of solar applications).



Figure 41. Solarimeter GIS R403. Source: GIS (n.d.)

In order to take advantage of solar radiation, "greenhouse" based sensors are used (see Figure 42), following this process:

1. The glass enclosure or certain translucent plastics are selective and let only pass the electromagnetic waves of a given frequency spectrum within which the solar radiation is located.
2. Upon reaching the absorber surface the radiation becomes infrared.
3. The heat passes from the absorber to the thermal fluid circuit and can be used in an external circuit.
4. Most energy is absorbed and the reverberated portion, with a longer wavelength, cannot pass through the enclosure, reflecting itself in the transparent enclosure. The process is repeated successively.
5. The hot water goes to the utilization circuit.



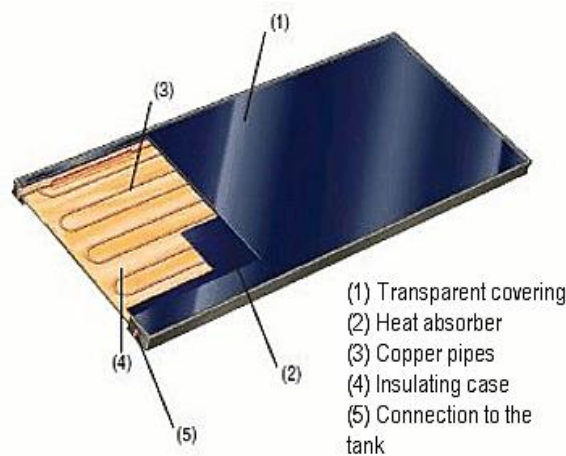

Figure 42. Flat solar collector. Source: Wind up Battery (n.d.)

These types of collectors are called "flat collectors" and are most commonly used in low temperature applications (below 80 ° C), such as pool heating and sanitary hot water. In them, the thermal insulation of the sensor minimizes heat losses by transmission and the case protects the sensor from inclement weather and mechanical shock.

For higher temperatures, other types are used, such as vacuum tubes or parabolic cylinder radiation (Figure 43), which allow their use in installations with higher requirements, such as solar ovens, steam generation, absorption refrigeration and solar thermal power plants.

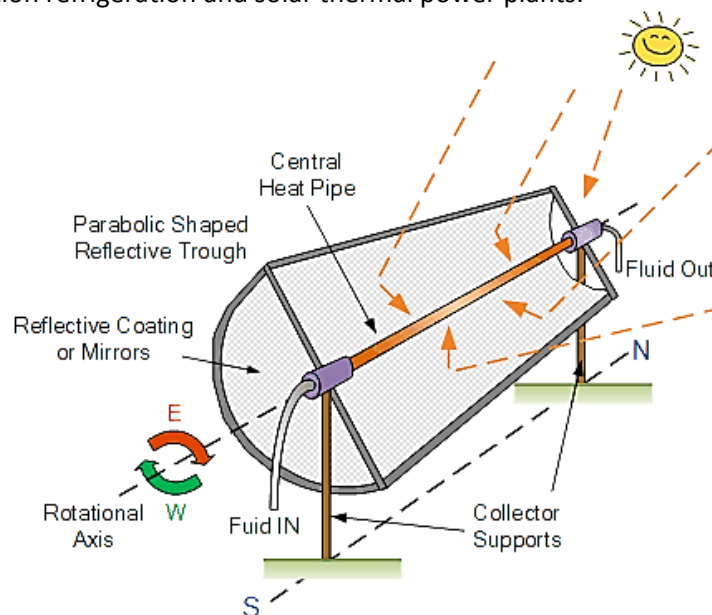

Figure 43 Parabolic collector. Source: Alternative Energy Tutorials (n.d.)

Although the efficiency of these last collectors is higher than the planes, only direct radiation can be used, which, together with their higher cost, can limit their use. Our objectives and the limits of this work make us focus exclusively on the flat sensors.

### SOLAR RADIATION INCIDENT ON A COLLECTOR

The solar radiation incident on a sensor located in the northern hemisphere reaches its maximum value when:



- a) It is oriented to the south (azimuth = 0)
- b) It has an angle of inclination equal to the latitude of its location, although if the greater benefits are required in winter the value of the angle must increase in  $10^\circ$ . If the maximum requirements are foreseen in summer the angle must decrease by  $10^\circ$ .

The azimuth is the angle that the sensor axis forms with the north-south axis, as seen in Figure 44. It is expressed in degrees clockwise sense.



Figura 44. Azimuth. Source: Wikimedia (n.d.)

In solar maps the irradiance is expressed with respect to a horizontal plane (inclination of panel 0) and it is necessary to apply a correction factor K to know the value of this magnitude in a given panel inclination, time and azimuth, since this value is the one that must be adopted in the calculations of dimensioning of the installation.

This process is complex, so it is necessary to use tables and spreadsheets, some of them available online. However, at a preliminary level, can be assumed average K-factor values ranging from 1 (horizontal plane) to 1.2 (inclination equal to latitude) and losses not exceeding 10 % for azimuth values between  $-30^\circ$  and  $+30^\circ$ .

### PERFORMANCE OF A COLLECTOR

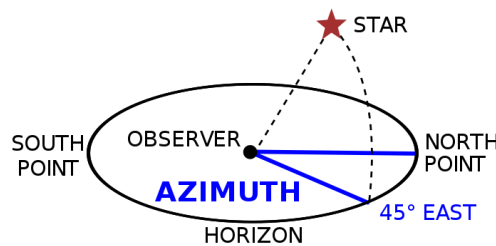
Low temperature heat transfer fluids (water, water mixtures with antifreeze and thermal oils) allow the use of solar radiation, thanks to its circulation through the primary circuit. This circuit consists of collectors and an indoor or outdoor heat exchanger (plates heat exchangers). The development of new heat conducting fluids of higher thermal conductivity, based on nanotechnology, can allow a greater efficiency of the systems of heat exchange and a possible reduction of the size and cost of the equipment. Figure 45 reproduces the basis of a water heating system with an accelerator pump.

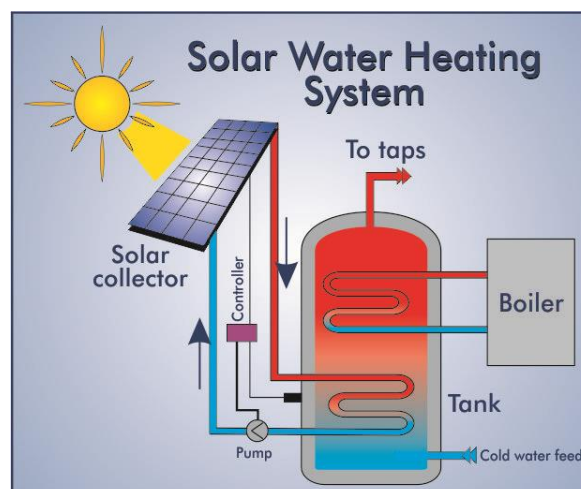

Figure 45. Water heating with accelerator pump. Source: Solar Power Facts (n.d.)



The losses and therefore the instantaneous efficiency of a solar energy collector are function of the intensity of the radiation in  $W/m^2$  and of the difference between the temperature of the collector and the one of the environment. As can be seen in Figure 46, the losses contemplated are:

- The optical losses occurring when the temperature of the heat transfer fluid coincides with the ambient temperature and they are due exclusively to the quality of the glazed enclosure of the collector.
- Thermal losses by transmission. High ration is considered at the values of  $800 W/m^2$  (summer), medium  $400-600 W/m^2$  and under  $200 W/m^2$  (winter).

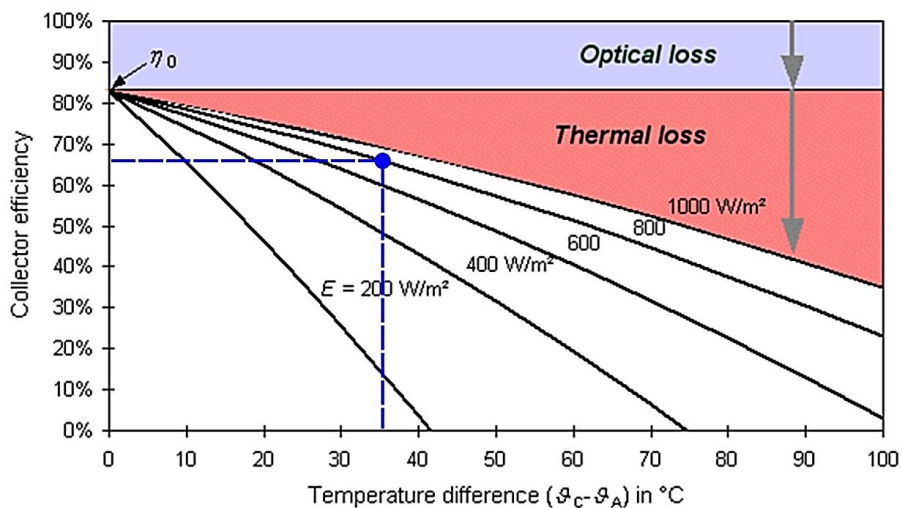

Figure 46. Efficiency curves of a high performance collector. Source: Volker Quaschnig (n.d.)

### EQUILIBRIUM BETWEEN USEFUL AND DEMANDED POWER

Unlike heating installations that operate only part of the year, sanitary hot water, in general, contrast the generated and required power (see Figure 47). This implies that in the summer months, when the useful power exceeds 110% of the demand, it is necessary to limit the production by covering or emptying part of the panels, or to eliminate the surplus by dissipating or diverting it to other energy uses. In small and medium-sized installations, it may be simpler to limit the number of collectors so that in the hottest months, the generated and requested power coincides and a complementary heat source (usually electricity or gas) is used in the rest of the year.

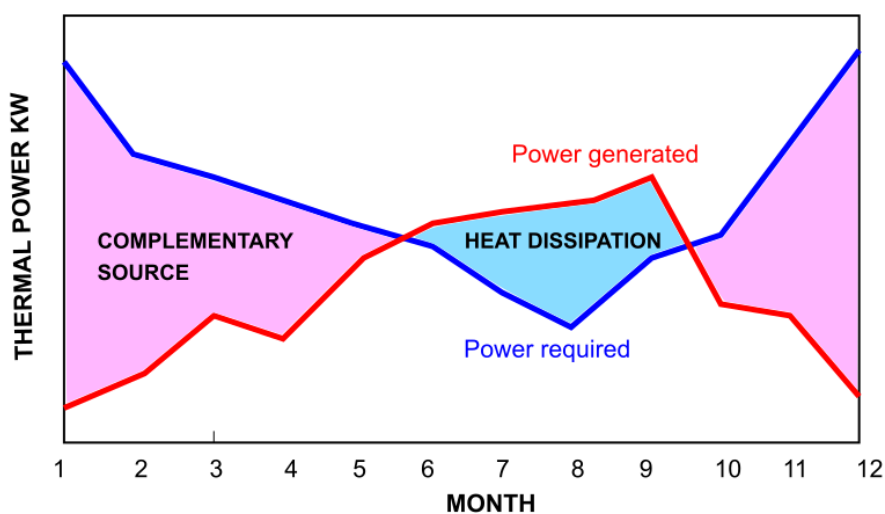

Figure 47. Curves of generated and demanded power. Source: Own elaboration



## 2.2.5. PHOTOVOLTAIC SOLAR ENERGY

### SOLAR RADIATION AND ELECTRICAL ENERGY

The concepts already mentioned in the above section (thermal solar energy) - solar radiation, irradiance, irradiation - are also useful in the field of photovoltaic energy. Considering that the value of the irradiance (and therefore of panel power) varies throughout the day and the seasons, the corresponding calculations are simplified by using peak solar hours or hours of equivalent solar radiation.

The daily irradiance (area of the rectangle of Figure 48) is equivalent to the one produced by a source with a constant irradiance of  $1\text{ kW/m}^2$  if it was operating for a certain time (peak solar hours or hours of equivalent solar radiation).

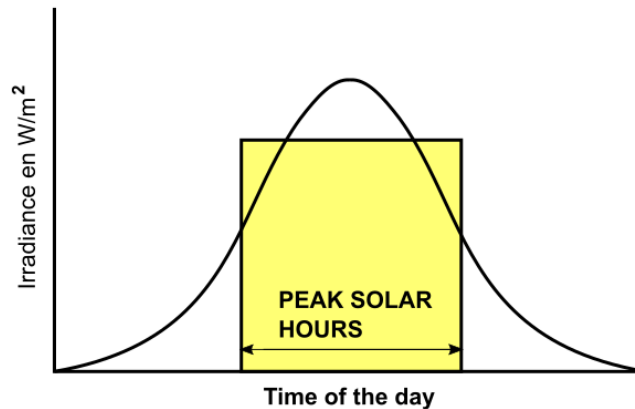

Figure 48. Irradiance and peak solar hours. Source: Own elaboration

There are two coexisting systems for converting solar radiation into electricity: concentrating thermoelectric power plants and Photovoltaic Solar Energy (PSE). The first, in the current state of the technology, is profitable for large facilities, outside the scope of our work.

PSE is a "mature" technology and has a wide range of possibilities from a few tens of watts to large solar farms of considerable power, equipped with sophisticated solar tracking systems. In addition, the costs have been significantly reduced, in many cases reaching the so-called "network parity", that is, the cost equality with the energy acquired in the external distribution network.

Out of the "solar farms", mainly destined to the sale of energy, and in the scope of our work, they are of special interest:

- a) Isolated installations (off-grid) that do not require connection to distribution networks, often nonexistent or with difficult access.
- b) Small installations connected to the external grid (on-grid with less than 10 kW in the case of Spain), which can be used as a complementary and/or emergency system and can significantly reduce the cost of energy storage equipment (batteries).
- c) The installations in intelligent bidirectional networks (net balance of energy) that allow the consumer to be simultaneously producer. This system is currently only covered by legislation in some countries.

### PHOTOVOLTAIC CELLS AND PANELS

#### General aspects

The photovoltaic effect is produced by the impact of solar radiation on a semiconductor. When this happens, in a solar photovoltaic cell (Figure 49) appears a voltage similar to that produced between



the terminals of a battery. The difference between both is that the battery is an accumulator of energy, while the photovoltaic cell is an instantaneous converter of solar energy in electricity, which ceases at sunset. Silicon is the most used semiconductor, which a normal individual cell, with an area of about 75 cm<sup>2</sup> and adequate illumination capable of supplying, under a potential difference of 0.4 V, a power of 1 W.

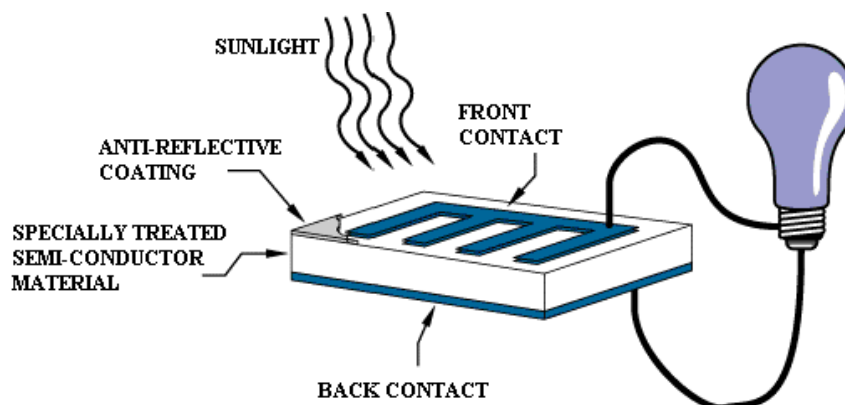

Figure 49. Photovoltaic cell. Source: Wikimedia (n.d.)

Photovoltaic panels are constructed using several identical silicon cells connected so that the voltage and current supplied by the panel are adequate. The monocrystalline panels are the ones with the highest efficiency, followed by the polycrystalline and the amorphous ones. However, in the selection process other factors should be taken into account, such as size, weight and cost.

### Parameters

The electrical characteristics of a photovoltaic panel, constituted by the association of solar cells, are determined for Standard Test Conditions (STC):

- Irradiance: 1 kW/m<sup>2</sup>
- Panel temperature: 25 °C
- Distribution of the light spectrum AM (Air Mass): 1,5
- Incidence of irradiation: Perpendicular to panel

Table 11 shows the characteristics of a typical photovoltaic panel, where:

- Rated power or peak power **W<sub>p</sub>**: maximum value available from the panel in STC
- Module efficiency: efficiency relative to solar irradiance
- Maximum power current and voltage: those corresponding to the nominal power ( $W_p = I_{mp} \times V_{mp}$ ).
- I<sub>sc</sub> short-circuit current: that obtained if the panel terminals are bridged.
- Open circuit voltage **V<sub>oc</sub>**: the measurement on a voltmeter at the output of the panel if there is no load.

Table 11. Technical characteristics of a photovoltaic panel. Source: Atersa, 2017  
Electrical characteristics (STC: 1 kW/m<sup>2</sup>, 25 °C ± 2 °C and AM 1,5)

	<b>A-200 M</b>
Rated power (±5 %)	200 W
Module efficiency	15.16%
Peak-point current of maximum power (I <sub>mp</sub> )	5.38 A
Peak-point voltage of maximum power (V <sub>mp</sub> )	37.18 A
Short-circuit current (I <sub>sc</sub> )	5.78 A
Open current voltage (V <sub>oc</sub> )	44.46 V



Other relevant parameters are:

- Nominal voltage, standardized in 12V multiples. Used to determine the characteristics of the accessories connected to the panel (regulator and batteries) and, in order to charge batteries, it must necessarily be lower than the open circuit voltage and, preferably, to the voltage of the point of maximum power. In the case of A-200M it will be 24 V.
- Rated current, equivalent to the current at the point of maximum power.

### Energy delivered

The energy generated by a photovoltaic panel can be calculated using a simple formula:

$$E = W_P \times H_E$$

- E = Electric power supplied daily by the panel
- $W_P$  = Nominal power or peak power
- $H_E$  = Peak hours or hours of equivalent solar radiation

This energy can be used for direct use (eg water pumping systems) and/or stored in accumulator battery (for example in a rural housing for daily or weekend use). In order to ensure the adequate duration of the batteries it is very important to do a careful analysis of the requirements.

The energy supplied by the photovoltaic panels must be what is needed to cover the planned consumption. As an example, we indicate the daily consumption for an isolated rural house in the summer months (Table 12). In this case, the kitchen is operated with another energy source, such as gas.

Table 12. Consumption table. Source: Own elaboration

Receiver	Power	Hours/day	Energy
Lighting (average value)	100 W	6	600 Wh
Bithermic washing machine	400 W	1.5	600 Wh
Refrigerator	150 W	12	1800 Wh
TV	100 W	4	400 Wh
Computer	100 W	2	200 Wh
Water pump	500 W	2	1000 Wh
Accelerator heating pump	50 W	----	-----
DAILY TOTAL ENERGY CONSUMED			4600 Wh
SIMULTANEOUS INSTALLATION MAXIMUM POWER			1400 W

### Orientation, inclination and connection of photovoltaic panels

As with solar thermal panels, the installations of photovoltaic panels in the Northern hemisphere have the maximum efficiency when they meet the following conditions:

- Orientation: South
- Degrees of average inclination: The same value as the latitude
- Facilities with predominant service in winter: Latitude + 10°
- Facilities with predominant service in summer: Latitude -10°

The highest performance is achieved using motorized solar tracking systems, but this requires a more complex technology and a higher cost, which may limit its use to the large facilities.

Photovoltaic panels interconnected to achieve greater system capacity must be of the same power, brand and model to avoid problems of efficiency and duration, or at least have the same power, short-



circuit current and open circuit voltage. They can be connected in series, parallel and serial-parallel, according to the characteristics of the panels and of the installation to be fed.

## ISOLATED FACILITIES

As discussed above, off-grid facilities do not have access to the external distribution net. Along with the photovoltaic panels, other elements are common to all types of facilities, such as the ones described below.

### Accumulators or storage batteries

The accumulator or storage battery allows, through a reversible chemical reaction, to store and use the electric energy produced by the photovoltaic panel according to the needs at each moment. Its capacity is expressed in Amperes-hour (Ah) which, in a fully charged accumulator, will correspond to the product of the intensity by the discharge time.

Thus, a 100 Ah accumulator type C20 can supply (if 100% full) a constant intensity of 5 A for 20 hours. Its duration is related to the so-called "depth of discharge" or part of its capacity in each load/unload cycle. Values of the order of 15-25 % are recommended, while values of 40-50 % should not be exceeded.



Figure 50. Stationary lead-acid battery. Source. Solar Quotes (n.d.)

The most used types in small photovoltaic installations are:

- Monoblock, lead-acid batteries, which require maintenance (Figure 50).
- AGM batteries, with a fiberglass blanket that immobilizes the liquid, without maintenance.
- Gel batteries, with gelled electrolyte, also without maintenance.

All of them must be "deep cycle" batteries, specially designed for photovoltaic energy, which have very different requirements (the use of batteries for automotive is not recommended). Their most frequent nominal voltages are 12V and 24V, and can be coupled together in series and in parallel.

### Charge regulators

The charge regulators are intended to adapt the output voltage of the photovoltaic panel to the optimum charge voltage of the batteries, irrespective of the values of both. In essence, the regulator should:

- Avoid the excessive overload provided by the photovoltaic panel in conditions of high irradiance.
- Limit the battery voltage to suitable values for its maintenance.
- Protect from overloads and short circuits at the input of panels and the output of consumption.





- Deactivate the battery in order to avoid overvoltages in the output circuit.
- Block the output in case of inversion of polarity and/or excessive temperature.

Usually the charge regulators are for bitensional (12-24 V) which implies that the connection of the equipment must be adjusted to the battery - photovoltaic panel - consumption sequence, so that the equipment firstly automatically detects the operating voltage. They are dimensioned considering the maximum intensity they can register, that is, the short-circuit current of the photovoltaic panels connected to them.

## Inverter

They are intended to convert the direct current from the battery (12 or 24 V) in alternating current at 230 V/50-60 Hz , for direct use in most receivers available on the market. The inverters can be used for isolated installations (Figure 51) and for installations connected to an external network.

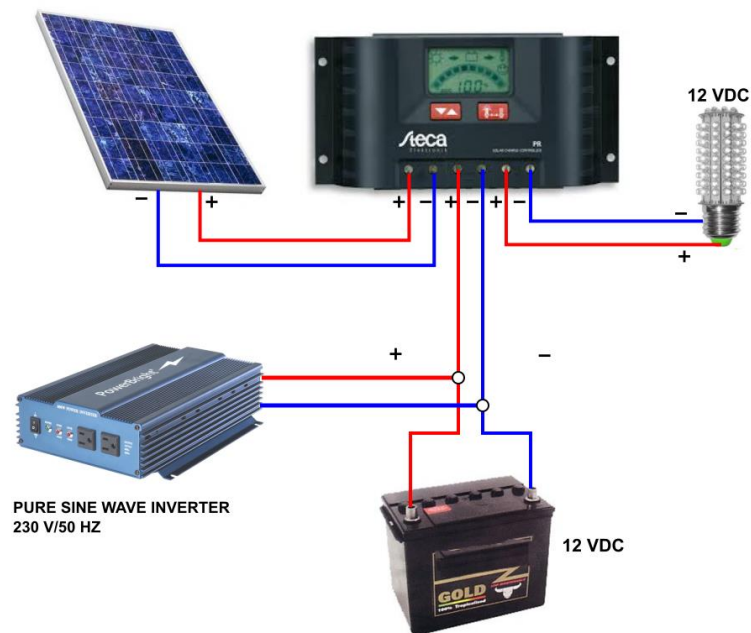

Figure 51. Isolated installation with charge regulator and inverter.  
Source: Own elaboration based on commercial catalogues

## Frequency converters

The speed of alternating current motors depends on their design characteristics (number of poles) and the frequency of the supply current. Frequency converters adapted for photovoltaic energy are connected to the direct current from the photovoltaic pannels, converting it to single-phase or three-phase alternating current of variable frequency. The control circuit causes this frequency (and therefore the speed of the connected motor) to be directly proportional to the solar irradiance at that time. This system, which does not require storage batteries, is mainly used for daytime water pump in isolated areas (Figure 52).

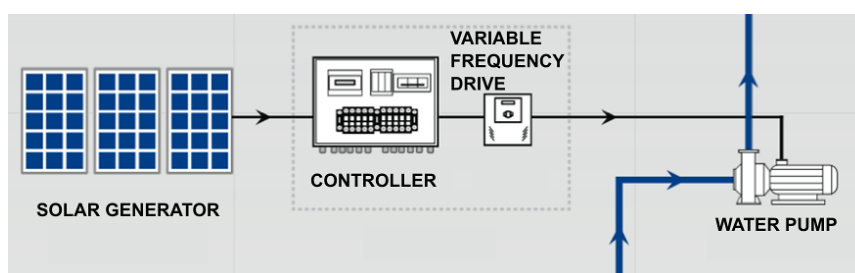

Figure 52. Water pump system with frequency inverter. Source: Atersa (n.d.)



## HYBRID SOLAR SYSTEMS

The alternative connection to the external distribution net allows that these installations use photovoltaic energy during the day and use the energy from the external network at night (or in adverse weather conditions). It makes possible to significantly reduce the size and cost of accumulating batteries and even eliminates them as shown in Figure 53.

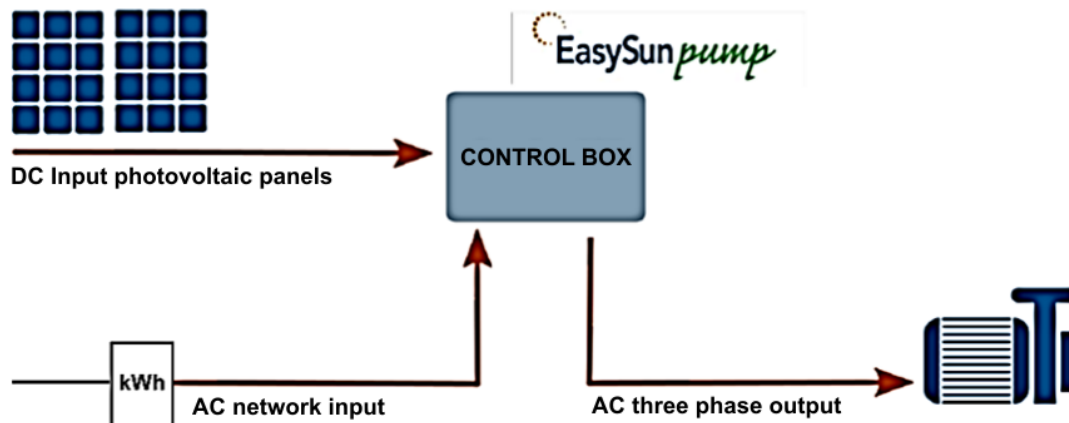

Figure 53. Switching installation for water pumping equipment. Source: Atersa (n.d.)

## WIND-PHOTOVOLTAIC HYBRID SYSTEMS

Considering that the production cycles of photovoltaic and wind are complementary, it is possible, by means of their parallel coupling, to achieve a production according to the consumption throughout the year. Sometimes, a supplementary supply is used, either through the connection to the external network, or through a generator set (see Figure 54). The regulator admits independent inputs from the wind turbine, the photovoltaic battery and the generator set or external network.

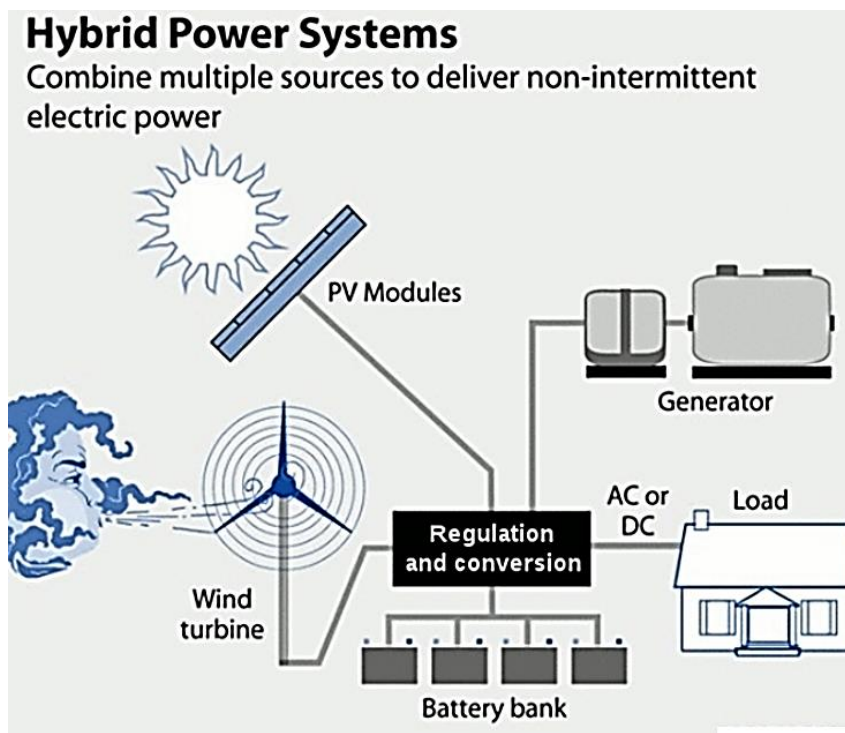

Figure 54. Wind-photovoltaic hybrid systems with photovoltaic modules, wind turbine and generator set. Source: Steamgreen (n.d.)



## SECOND PART

# BEST PRACTICE IN RURAL ENERGY TRANSITION: BIOMASS MANAGEMENT FOR RURAL DEVELOPMENT IN SERRA

### What will you find in this part of the guide?

As the main goal of this guide to facilitate the promotion of renewable energies among small municipalities, this part describes a best practice sample that can inspire new initiatives in similar contexts. The selected case is the sustainable biomass management in Serra, a small municipality located in the Valencian Region (Spain), which reflects the synergies between energy transition and local development.

In the next sections, the reader will find a brief introduction with basic data about Serra, the analysis of the technical solution adopted in the municipal nursery school and some considerations about the socioeconomic and environmental impact.

### 3. KNOWING THE CONTEXT: THE MUNICIPALITY OF SERRA

Serra is a municipality located in the Natural Park Sierra Calderona of the Valencian Region (Spain). Has an average altitude of 330 m above sea level and its area is 5,706 hectares. Due to its **geographic** location, it has large slopes that exceed 50 % and its height above sea level fluctuates between 180 and more than 800 meters.



Figure 55. Panoramic of Serra. Source: Municipality of Serra (n.d.)



The **climate** is Mediterranean, with temperatures that may vary between 4 °C in winter and 28 °C in summer. The annual rainfall fluctuates between 450 mm and 500 mm.

There is a great **botanical diversity** depending on the climate and the type of soil. The wooded areas are dominated by the “rodeno” pine (*pinus pinaster*) on siliceous land and “carrasco” pine (*pinus halepensis*) on calcareous land. The shrubs (such as *lentiscus* and *arbutus*) form thick patches of vegetation that prevent erosion and retain moisture.

According to the Spanish Statistics National Institute, the **population** of Serra in 2015 was 3,142 inhabitants. Nevertheless, during the weekends and holidays (Christmas, Easter and summertime) the population may reach to 10,000 people.

Table 13 shows basic statistical data about the location and demography of Serra.

Table 13. Data about the location and demography of Serra.  
Source: Own elaboration based on Instituto Valenciano de Estadística (2016)

BASIC STATISTICAL DATA ABOUT SERRA	
Country	Spain
Province	Valencia
Distance to the capital of the province (km)	26.5
Altitude (m)	330
Surface (km <sup>2</sup> )	57.29
Population density (inhabitants/km <sup>2</sup> ) – 2015	54.84
Population (1 January 2015)	3,142

The main **economic** sector of Serra is the agriculture. According to the municipality estimations, the cultivation surface in 2015 was distributed among fruit trees (41.8%), citrus fruites (37.8 %) and olive trees (20.2 %). The tourism is growing and Serra is a residential area due to its proximity to the city of Valencia and its natural attractions, which are ideal for mountaineering, hiking and cycling. Other economic activities are cattle industry, construction and mechanical carpentry. Table 14 provides information about the active enterprises in 2016.

Table 14. Active enterprises in 2016 (except primary sector).  
Source: Own elaboration based on Instituto Valenciano de Estadística (2016)

ACTIVE ENTERPRISES – 2016 (except primary sector)	
Industry	9
Construction	39
Services	171
Total	219

Since 2011, Serra has been pioneer in the **biomass** energetic exploitation thanks to a project leaded by the municipality. This project is based on a comprehensive management of the green waste coming from gardening, agricultural works and the forest that is processed locally to provide energy for municipal facilities (nursery, school and town hall). The project has been recognized at national and international level and continues progressing with the commercialization of the combustible and the protection of the Natural Park Sierra Calderona.



## 4. THE BIOMASS PROJECT IN A NUTSHELL

As it has been mentioned in the previous section, Serra is a small municipality of Valencian Region, where 95% of the territory is located in the Natural Park of Sierra Calderona and **85% is forest**.

In 2011, during the economic crisis, the costs of the green waste management were 90,000 € per year. The main goal of the biomass project was to reduce these costs by the conversion of green waste (from gardens, farms and forest) in a biomass fuel that could be employed by the local administration. In addition to the costs of the green waste management and the energy invoices, it also has positive effects on the protection of the natural environment, the contamination reduction and the employment creation (Municipality of Serra, 2015).

### PHASE I: WOOD CHIPS AND THE MUNICIPAL BUILDINGS

The first steps were to produce their own biomass and to convert the public administration in a consumer of the generated fuel. The starting point was the replacement of the traditional heat sources (electric power) by biomass heating systems (boilers, hot water circuits and radiators) in two public facilities: the nursery school and the municipality. At the same time, the green waste was reconverted into an profitable biomass fuel with the minor possible cost for the municipality (Figures 56 and 57).



Figure 56. Biomass storage. Source: Own elaboration



Figure 57. Municipal nursery. Source: Own elaboration

To make it possible, the decision makers of the municipality used some funds coming from the provincial administration (usually used for public construction) to:

- Acquire an autonomous forest chipper with a diesel motor (60 CC) and capacity to crush logs up to 25 cm. in diameter.
- Install a heating system with hot water and radiators fed by a polifuel biomass boiler (35 kW).

At the end of the first winter the municipality obtained a total saving superior to 19,000 €, including waste management and electric billing.

### PHASE II: PELLETIZING AND THE CITY HALL

Considering the positive impacts of the Phase I and taking into account that in the chips production part of the green waste was not used, the improvement of the biomass fuel production process was proposed. To this end, the municipality acquired a fine grinder and a pelletizer with capacity to produce 100 kg of pellet per hour. At the same time, the city council replaced the electric heat sources by a radiators installation fed with a hot water circuit and a polifuel biomass boiler of 65 kW.



Figure 58 shows part of the facilities and equipment for the pellet production and Figure 59 shows a detail of the pellet bags produced in Serra.



Figure 58. Pellet production. Source: Own elaboration



Figure 59. Serra produced pellet. Source: Own elaboration

## BALANCE OF THE PROJECT

Seeing both phases and the pellet production for the two boilers, the global balance of the project is that it allows annual savings of more than 37,000 € in waste management and electric billing, the reduction of more than 250 tonnes of CO<sub>2</sub> emissions per year and the capacity to create 15 employments linked to the biomass production.

The biomass project management continues its evolution with the incorporation of forest and agriculture residues. This approach facilitates the biomass valorization and the cleaning and regeneration of Serra natural heritage, contributing to the fire prevention and the employment creation. Thus, Serra's pilot project can be extrapolated to other municipalities of diverse nature and different peculiarities, but with common aspects, such as the need for green waste treatment.

## 5. DETAILS OF THE MUNICIPAL NURSERY HEATING INSTALLATION

In order to facilitate the comprehension of the process followed in Serra, this section describes in detail the steps followed to design the heating installation in the municipal nursery.

### SITUATION

For this simplified calculation we will consider that the main façade is oriented to the North, although in fact it is to the Northwest (Figure 60). This allows us to achieve a certain margin of safety, considering that, when it is North oriented the heat losses are the highest. Figure 61 shows the boiler room.



Figure 60. Nursery orientation.  
Source: Municipality of Serra (2011)



Figure 61. Boiler room. Source: Own elaboration



## TECHNOLOGICAL SOLUTION

A priori, after considering different options (use of liquid fuels, use of underfloor heating, etc.) the Municipality of Serra decided that the best alternative was a central heating installation using an improved biomass multi-fuel boiler (wood chips, pellets...), multi-layer pipe distribution network and terminal units of cast aluminium. Above all, the following have been taken into account:

- a) Availability and price of the fuel
- b) The practically null environmental pollution
- c) The rapidity of the system activation, essential because of the intermittent use of the installation

## DIAGRAM OF THE INSTALLATION

The next step has been to establish the scheme of the installation to be carried out. The diagram in the Figure 62 is based on the one already used in section 2.2.1. and its components are:

1. Storage tank for solid biomass
2. Electronic control boiler and automatic cleaning of soot
3. Thermal storage tank (inertia tank)
4. Expansion tank
5. Recirculation pumps in the primary and secondary circuits
6. Radiators (thermal emitters)

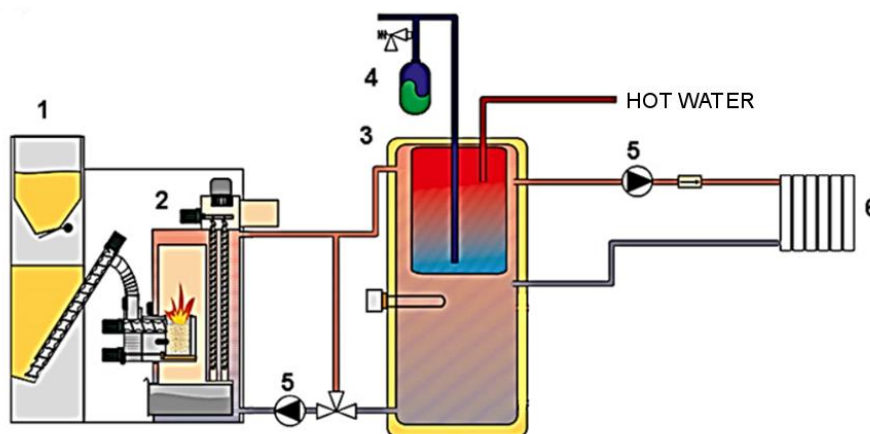

Figure 62. Diagram of the installation. Source: Adapted from Domusa (n.d.)

## CALCULATION PROCEDURE

We refer to the tables and considerations specified in the paragraph "Heating installations with solid biomass" of the section 2.2.1. Therefore it will be necessary to:

- a) Determine the power density of the installation
- b) Calculate the power of the boiler according to the total constructed surface
- c) Distribute this power between the rooms to be heated
- d) Establish the characteristics of the radiators to be installed in each of the aforementioned rooms
- e) Determine the capacity of the thermal storage tank

As estimated that exceeds the scope of our work, the following parts will not be dimensioned:



- Diameter of distribution pipes
- Pressure and flow rate of the primary and secondary circuits recirculating pumps
- Expansion tank
- Control equipment

## DETERMINATION OF THE INSTALLATION POWER DENSITY

The thermal power density is established from Table 15 taking into account:

- The climatology of the area and the fact that the nursery building will only need daytime heating.
- The most unfavourable orientation, that is, the North orientation as discussed above.
- The high quality of the enclosures (wood sandwich panels and rock wool in the vertical walls and insulated cover)

For this reason it is accepted as temperature gradient 24 K (inside +22 °C, outside -2 °C) resulting in a **thermal power density of 76 W/m<sup>2</sup>**

Table 15. Thermal power density. Source: Own elaboration

INSULATION TYPE	IK	TD	W/m <sup>2</sup> according to orientation				
			S	W	E	N	Average
With thermal panel 50 mm and double glazing	1	20K	39	55	59	63	54
		24K	47	66	71	76	65
		28K	55	78	83	89	76
Air chamber and single glazing	1,5	20K	65	70	74	79	72
		24K	86	92	99	105	96
		28K	101	108	116	123	113

## SELECTION OF THE BOILER

In the first place we have to determine the total area constructed according to the values that are included in the project of the municipal nursery. That is, the surface corresponding to the outer perimeter of the building (Table 16).

Table 16. Constructed area of the building. Source: Own elaboration based on Municipality of Serra (2010)

Rooms	Surface
Classes 0-1 years	71.31 m <sup>2</sup>
Classes 1-2 years	66.21 m <sup>2</sup>
Classes 2-3 years	90.57 m <sup>2</sup>
Workers toilets	6.97 m <sup>2</sup>
Classroom toilets	30.12 m <sup>2</sup>
Kitchen	12.94 m <sup>2</sup>
Multipurpose room 1	14.71 m <sup>2</sup>
Multipurpose room 2	33.10 m <sup>2</sup>
Distributor	39.71 m <sup>2</sup>
Total	365.64 m <sup>2</sup>

Starting from the thermal power density required to compensate the heat losses, which we have determined in the previous section, the required power will be:

$$P = 365.64 \text{ m}^2 \times 76 \text{ W/m}^2 = 27,788 \text{ W}$$





Estimating the losses in the pipes by 15%, the power of the boiler should be at least:

$$P_u = 27,788 \text{ W} \times 1.15 = 31,956.2 \text{ W} \sim 32 \text{ kW}$$

After a technical and economic analysis, a Lasian Bioselect Plus boiler with a nominal power of 35 kW (Figure 63) has been selected.



Figure 63. Poly-fuel boiler. Source: Lasian (n.d.)

Characteristics:

- Boiler with automatic ignition
- Automatic boiler for solid fuels such as pellets, almond shells, olive cake and olive stones
- Steel body and automatic cleaning as standard
- Large compartment for ash accumulation
- User-friendly, electronic control with 2 automatic options
- Easy operation and minimal maintenance
- Meet the requirements of the standard EN 303-5
- Working pressure 4 bar

#### DISTRIBUTION OF THERMAL POWER AMONG ROOMS TO BE HEATED

The thermal power needed to compensate the transmission and air-renewal losses, determined in the previous section ( $P = 27,788 \text{ W}$ ), shall be distributed to be directly proportional to the surfaces of each room to be directly heated (that is, only those in which radiators will be installed), excluding the bathrooms, hall and kitchen, as shown in Table 17 and Figure 64.

Table 17. Thermal power in rooms with direct heating. Source: Own elaboration

ROOM	SURFACE	W/m <sup>2</sup>	THERMAL POWER
1	34.22 m <sup>2</sup>	$27,788/252.21 = 110.17$	3,770 W
2	30.65 m <sup>2</sup>		3,377 W
3	30.65 m <sup>2</sup>		3,377 W
4	41.21 m <sup>2</sup>		4,540 W
5	12.97 m <sup>2</sup>		1,430 W
6	30.65 m <sup>2</sup>		3,377 W
7	30.65 m <sup>2</sup>		3,377 W
8	41.21 m <sup>2</sup>		4,540 W
TOTAL	252.21 m <sup>2</sup>		27,788 W



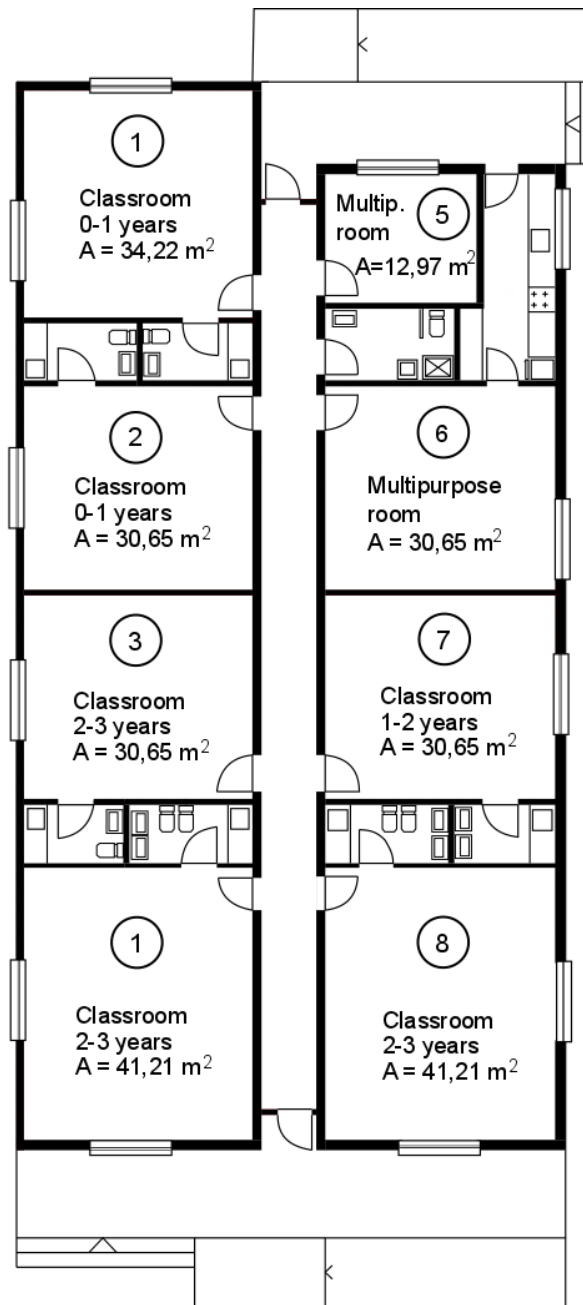

Figure 64. Rooms with direct heating. Municipality of Serra (2010)

## CHARACTERISTICS OF RADIATORS

The most suitable radiators in this case are made of cast aluminum. We will use the nomenclature in which the size of the sender is expressed by the notation **Size = Height in cm x number of elements**. The radiator of Figure 65 is 60 x 10 elements. This height is the most adequate in view of the characteristics of the building.

The manufacturer's technical catalog indicates that the thermal performance for each of its components is 89.2 W/element for the following operating conditions:

- Ambient temperature: 20 °C
- Water inlet temperature: 70 °C
- Water outlet temperature: 50 °C
- Average temperature in the radiator: 60 °C



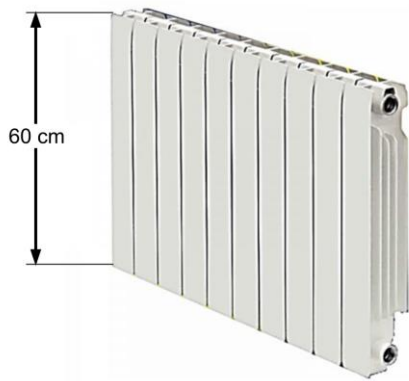

Figure 65. Radiator. Source: Ferroli Europa (n.d.)



Figure 66. Radiator in the nursery. Source: Own elaboration

This means that the radiator of Figure 65 will have a power of **89.2 W/element x 10 elements = 892 W**. Figure 66 shows a radiator in one of the rooms of the nursery. Once the type of radiator has been decided, we must determine the number of elements for each radiator from the required thermal powers and the number of radiators per room (Figure 67, Table 18).

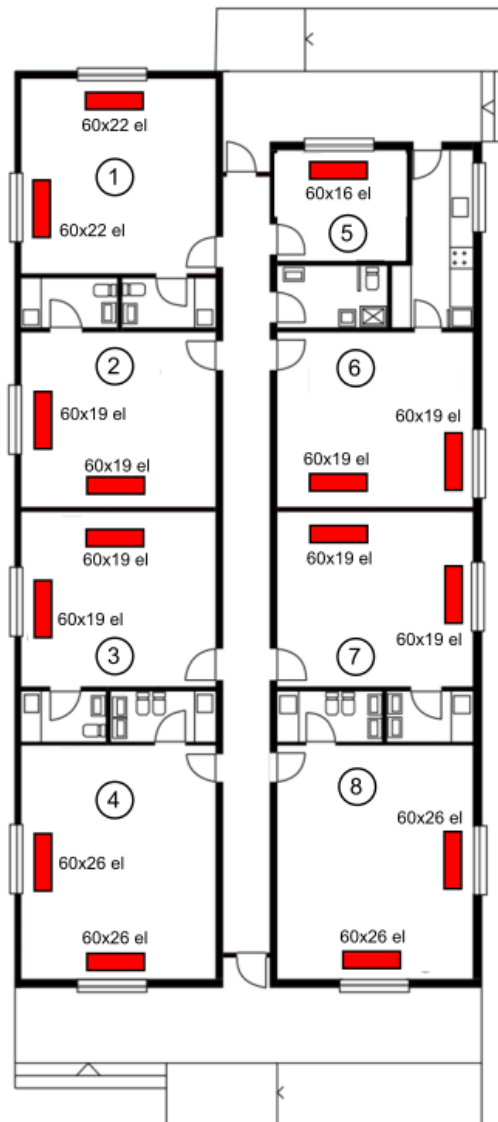

Figure 67. Distribution of radiators. Source: Municipality of Serra (2010)



Table 18. Selection of radiators. Source: Own elaboration

ROOM	THERMAL POWER	RADIATORS	
		Nº	Type
1	3,770 W	2	60 x 22 elements
2	3,377 W	2	60 x 19 elements
3	3,337 W	2	60 x 19 elements
4	4,540 W	2	60 x 26 elements
5	1,430 W	1	60 x 16 elements
6	3,377 W	2	60 x 19 elements
7	3,377 W	2	60 x 19 elements
8	4,540 W	2	60 x 26 elements
		TOTAL	316 elements
		Total thermal power	316 x 89.2 = 28,187 W

### THERMAL ACCUMULATOR OR INERTIA DEPOSIT

The Technical guide for thermal biomass installations in buildings (IDAE, 2009) gives us guidelines for the size of the thermal accumulators, establishing their capacity between 20 and 30 litres/kW, value accepted by different manufacturers for small installations. With an average value of 25 litres/kW the inertia tank requires a capacity of the order of:

$$C = 35 \text{ kW} \times 25 \text{ litres} = 875 \text{ litres}$$

### SUITABILITY OF THE INSTALLATION

Throughout several years of operation, the facility has proven its correct operation, even in extreme weather conditions This allow us to validate the calculation criteria adopted, confirming the suitability of the selection solution. Figures 68 to 71 show details of the nursery construction and functioning.



Figure 68. Construction with sandwich panels (wood, rockwool and wood). Source: Municipality of Serra (2011)



Figure 69. Insulated windows (double glazed). Source: Own elaboration



Figure 70. Room. Source: Own elaboration



Figure 71. Open air area. Source: Own elaboration



## 6. IMPACTS OF THE BIOMASS PROJECT

The following analysis is partly based on the theoretical guides for the empirical study of renewable energies contribution to sustainable rural development (Burguillo, 2008). These guides integrate the concepts of rural development (local and endogenous) and sustainable development.

Through qualitative tools (direct observation and semi-structured interviews), the research team has carried out an analysis of the socioeconomic and environmental variables in the Serra biomass project, which are described in the next paragraphs. The information provided has been extracted from the interviews carried out to the environment city councillor, the municipal engineer, the local development agent, the director of the nursery and the person in charge of the biomass production.

- a) *Quantitative and qualitative impact on the employment*, which includes:
  - Five permanent positions financed by the Municipality. Two of these persons work in the pellet preparation and three in the forestry and gardening waste collection. These persons were already working in the municipality and have been transferred (other persons have been hired to cover their vacancies).
  - Three rotative positions three times per year to collect the forestry waste and to produce the pellet, that means nine persons in a year. These persons were unemployed and usually come from the construction sector. They have a medium-low professional profile and they are of medium age. Thus, they represent a sector of difficult employability. The funds to hire these persons are managed by the municipality and derive from a SERVEF (Valencian Service for Employment and Training) programme addressed to reduce unemployment among collectives at risk of socioeconomic exclusion.
- b) *Impact on the local productive fabric and in the productive diversity*. Before the economic crisis, Serra's economy focused on the construction sector. Nowadays, Serra is trying to impulse both traditional and new economic activities such as ecological agriculture (there is an ecological women cooperative), arts and crafts (honey, esparto) and tourism (mountain, cultural). The success of the biomass project has encouraged the implementation of these kinds of activities. In addition, the local production of pellets will be mainly sold to the municipality and Serra's inhabitants, contributing to the economic viability of the project.
- c) *Impact on the energetic self-sufficiency*. The biomass project is decreasing the energy dependence while increasing the flexibility and the security of the energy provision in the municipality (Figure 72).
- d) *Impact on the municipal savings*. It is estimated that there has been a reduction of 40% in the energy bill thanks to the use of biomass in the municipal installations. In addition, the cost of the waste management has also been minimized thanks to its reutilization.
- e) *Impact on the population education and awareness* through the following channels:
  - Specific training in the municipal installations of the persons working in the green waste collection and in the pellet production process. The new competences acquired by the employees are mainly related to the use of the equipment.
  - Awareness of the people living in Serra, both the persons working directly in municipal installations and persons using the municipal services (such as parents of the children going to the nursery).
- f) *Implication of the local actors*. The implementation of the project has been facilitated thanks to the favourable opinion of the local actors, which has a direct effect in the sustainability of the action in the middle and long term. The support of the local actors has been increasing during the project life cycle thanks to its successful implementation. The public acceptance of the project is directly linked with the perception of the generated benefits (impact on the landscape, reduction of municipal energy bills, new visitors...).



- g) *Impact on the tourism.* The dissemination of the project outside Serra has made possible that people from Valencian Region, neighbouring regions and other parts of Europe visit the village to know how the biomass is being managed. Among these people, there can be found municipal technicians, representatives of local governments and universities (students and/or professors).
- h) *Impact on the local R+D+i.* The technology used in all the phases of the project is appropriate technology, which means, technology designed with special attention to the environment, cultural, social and economic characteristics of Serra. The reduced cost of the equipment and installations and the use of local resources represent advantages for the sustainability of the project in the middle and long term.
- i) *Impact on the use of endogenous resources.* The main physical resources and human capital of the biomass project are located in Serra (Figure 73). This contributes to strengthen the bottom-up approach that characterises the local development processes. This approach is complemented with some external elements, such as the technology (boilers, chipper, weeding machine...).
- j) *Impact on other municipes, SMEs and inhabitants.* Thanks to the good results of the project, there is an “echo-effect” and other organisations and individuals have changed to biomass boilers or are in the process to do it. This is happening mainly in Serra, but also in the surroundings and neighbouring territories. Some specific examples of individuals are the relatives of the councillor and an employee of the nursery. As a sample of institution it can be mentioned the Municipality of Vistabella (in Castellón, a neighbour province).
- k) *Impact on the fire prevention.* The biomass forestry is coming mainly from bushes and dead pines (because of *Tomicus*), what is a big contribution to the maintenance and cleaning of the forest. In fact, one important value for the population is that the project is helping to “take care” of the mountain. Moreover, the collection of farming waste is reducing their burning by the farmers, a traditional activity that the municipality pretends to eliminate. This is highly relevant because the Natural Park of Sierra Calderona is prone to fires (in fact, the last fire in the Park took place in June 2017 and more than 1,000 hectares were burned).
- l) *Impact on the Climate Change.* The CO<sub>2</sub> emissions have been reduced due to the minimization of the use of fuel sources in municipal installations. The ashes from biomass combustion are used for gardening.



Figure 72. Serra city council. Source: Own elaboration



Figure 73. Juan Jose Mayans (municipal engineer) and Jose Ros (biomass operator). Source: Own elaboration



## REFERENCES

- Arnanz, L. (2011). *Metodología participativa y cooperación para el desarrollo*. Madrid: CIMAS
- Atersa (n.d.). Available on: <http://www.atersa.com/>
- Burguillo, M. and del Río, P. (2008). La contribución de las energías renovables al desarrollo rural sostenible en la unión europea: pautas teóricas para el análisis empírico. *Tribuna de Economía* (845), p. 149-165.
- Covenant of Mayors for Climate and Energy (2015). Available on: <http://www.covenantofmayors.eu/>
- Domusa (n.d.). Available on: <http://www.domusateknik.com/es/descargas/catalogos-producto/calderas-biomasa?source=descargas>
- Dubois, A. (2014). *Marco teórico y metodológico del Desarrollo Humano Local*. Bilbao: Hegoa
- Enair (n.d.). Available on: <https://www.enair.es/>
- Endesa (n.d.). *Hydroelectric power stations*. Available on: [http://www.endesaeduca.com/Endesa\\_educar/ingles/recursos-interactivos/produccion-de-electricidad/xi.-las-centrales-hidroelectricas](http://www.endesaeduca.com/Endesa_educar/ingles/recursos-interactivos/produccion-de-electricidad/xi.-las-centrales-hidroelectricas)
- European Commission (2004). *Project Cycle Management Guidelines*. Brussels.
- European Commission (2009). *Directive 2009/28/EC of the European Parliament and of the Council of 23 April 2009 on the promotion of the use of energy from renewable sources and amending and subsequently repealing Directives 2001/77/EC and 2003/30/EC*. Available on: <http://eur-lex.europa.eu/legal-content/EN/ALL/?uri=CELEX:32009L0028/>
- European LEADER Association for Rural Development (n.d.). Available on: <http://www.elard.eu/>
- EURO-SOLAR (2013). *Manual técnico de replicabilidad sobre proyectos de energías renovables y desarrollo rural*. Available on: [https://ec.europa.eu/europeaid/file/31542/download\\_en?token=wpuYdK5o](https://ec.europa.eu/europeaid/file/31542/download_en?token=wpuYdK5o)
- Eurostat (2015). Available on: <http://ec.europa.eu/eurostat/web/population-demography/>
- Fagor (n.d.). *Energía solar térmica*. Available on: [http://www2.fagor.com/es/solar/productos/solararter/catalogos/catalogo\\_solar\\_termica.pdf](http://www2.fagor.com/es/solar/productos/solararter/catalogos/catalogo_solar_termica.pdf)
- FAO (2012). *Guide to the Project Cycle*. Rome.
- Geilfus, F. (2008). *80 tools for participatory development: Appraisal, planning, follow-up and evaluation*. San José de Costa Rica: IICA
- Gobierno de Canarias (2004). *Guía técnica de aplicación para instalaciones de energías renovables: instalaciones fotovoltaicas*. Available on: [http://www.agenergia.org/files/resourcesmodule/@random49914e4ed9045/1234263307\\_GuiaFotoVoltaicaGobCan.pdf](http://www.agenergia.org/files/resourcesmodule/@random49914e4ed9045/1234263307_GuiaFotoVoltaicaGobCan.pdf)
- IDAE (2007). *Energía de la biomasa*. Available on: [http://www.idae.es/uploads/documentos/documentos\\_10374\\_Energia\\_de\\_la\\_biomasa\\_07\\_28e17c9c.pdf](http://www.idae.es/uploads/documentos/documentos_10374_Energia_de_la_biomasa_07_28e17c9c.pdf)
- Instituto Nacional de Estadística (2015). *Encuesta de Población Activa*. Available on: <http://www.ine.es/>



- Instituto Valenciano de Estadística (2016). Available on: <http://www.pegv.gva.es/>
- IVACE (2013). *Datos energéticos de la Comunidad Valenciana 2013*. Available on: <http://www.dadesobertes.gva.es/storage/f/file/20160823143149/datos-energeticos---2013.pdf>
- LEADER (1998). *Fuentes de energía renovable, fuentes de desarrollo sostenible*. Available on: <http://ec.europa.eu/agriculture/rur/leader2/rural-es/biblio/energy/energy.pdf>
- Martí, J. (2008). *Biodigestores familiares: Guía de diseño y manual de instalación*. GTZ. Available on: [http://www.cedecap.org.pe/uploads/biblioteca/10bib\\_arch.pdf](http://www.cedecap.org.pe/uploads/biblioteca/10bib_arch.pdf)
- Mayans, J. (2015). SERRA: Biomass, Energy and Employment. *IN2RURAL Multiplier Event: 1ª Fira d'energies renovables d'Atzeneta*. Available on: [http://in2rural.ub.ro/files/TM/Prezentari\\_Sp/serra.pdf](http://in2rural.ub.ro/files/TM/Prezentari_Sp/serra.pdf)
- Montesinos, A. (ed.) (2007). *Diez preguntas y respuestas sobre energía eólica*. La Habana: Cubasolar. Available on: <http://www.cubasolar.cu/biblioteca/libros.htm>
- Morales, A. y Zulueta, M. (1988). *Guía práctica de calefacción individual o doméstica*. Tedecsa.
- Municipality of Serra (2015). *Serra biomass, energy and employment*. Available on: <https://www.youtube.com/watch?v=GB8WdXFxsho>
- Municipality of Serra (n.d.). Available on: <http://www.serra.es/>
- Murguialday, C. and Alberdi, J. (2006). *Diccionario Hegoa de Acción Humanitaria y Cooperación al Desarrollo*. Icaria y Hegoa.
- OECD/DAC (1998). *Review of the DAC Principles for Evaluation of Development Assistance*. Paris.
- Powerpal (2017). Available on: <http://www.powerpal.com/products.html>
- Quintana, J., Cazorla, A. y Merino, J. (1999). *Desarrollo rural en la Unión Europea: modelos de participación social*. Madrid: Ministerio de Agricultura, Pesca y Alimentación.
- Spanish Government (2010). *Spain's National Renewable Energy Action Plan 2011-2020*. Available on: <https://ec.europa.eu/energy/en/topics/renewable-energy/national-action-plans>
- Sky Renewable Energy (n.d.). Available on: <http://www.skyrenewableenergy.com/>
- UN (2015 a). *Transforming Our World: The 2030 Agenda for Sustainable Development*. New York.
- UN (2015 b). *Paris Agreement*. Available on: [http://unfccc.int/paris\\_agreement/items/9485.php](http://unfccc.int/paris_agreement/items/9485.php)
- US Energy Department (n.d.). *Sistemas eólicos pequeños para generación de electricidad*. Available on: <http://www.nrel.gov/docs/fy07osti/42071.pdf>





Sustainable energy and climate action are critical for European Union local and regional authorities, who have voluntarily assumed the commitment to implement the EU's objectives on their territories through The Covenant of Mayors for Climate and Energy. This bottom-up initiative, which started in 2015, looks forward to decarbonised, resilient and efficient cities. To this end, it establishes the target of decreasing at least 40% of the CO2 emissions by 2030, through greater use of renewable energy sources and improved energy efficiency measures.

At the same time, the depopulation of rural areas (90% of the EU's land mass) is one of the most relevant changes for policy makers. In fact, demographic changes are directly associated to the problem of young people moving towards bigger towns due to the lack of opportunities (jobs, services, infrastructure) in the countryside. Although in the rural areas there is a high potential to promote renewable energies, the lack of information and the limited dissemination of best practices make it difficult for small municipalities to take advantage of the possible benefits of a viable energy model.

In the frame of the Erasmus+ project IN2RURAL and taking into account both challenges (energy transition and depopulation), this guide aims at supporting local initiatives that generate new opportunities for the socioeconomic development of small rural areas through renewable energies.



Co-funded by the  
Erasmus+ Programme  
of the European Union